

Residential Air Conditioners *SR*series

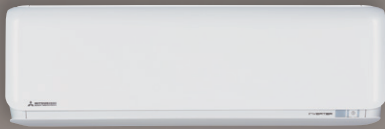

High Performance Air Conditioning

2024



Bringing energy efficient advanced technology solutions

Residential Air Conditioners



What solutions can Mitsubishi Heavy Industries Air Conditioner offer?

- Keep comfortable with quick cool-down/warm-up
- Energy saving for a sustainable future
- Innovative design suitable for all interiors
- Reliable air conditioner for long term use

Mitsubishi Heavy Industries advanced technology can provide a variety of solutions.

Elegant Timeless Design

The ZSX/ZS and ZTL series air conditioners have been innovatively designed with rounded contours that fit beautifully into Europe's diverse interior.



ZSX series



ZTL series

Quiet and Comfortable

Mitsubishi Heavy Industries Thermal Systems offers a unique modest air conditioner; quiet and comfortable which provides precise air flow and capacity control.

Energy Saving

High energy saving with comfort. Provides the user multiple solutions in comfort and energy savings. All the models can achieve high energy efficiency by use of Mitsubishi Heavy Industries technology, such as high performance compressor, DC PAM inverter technology.

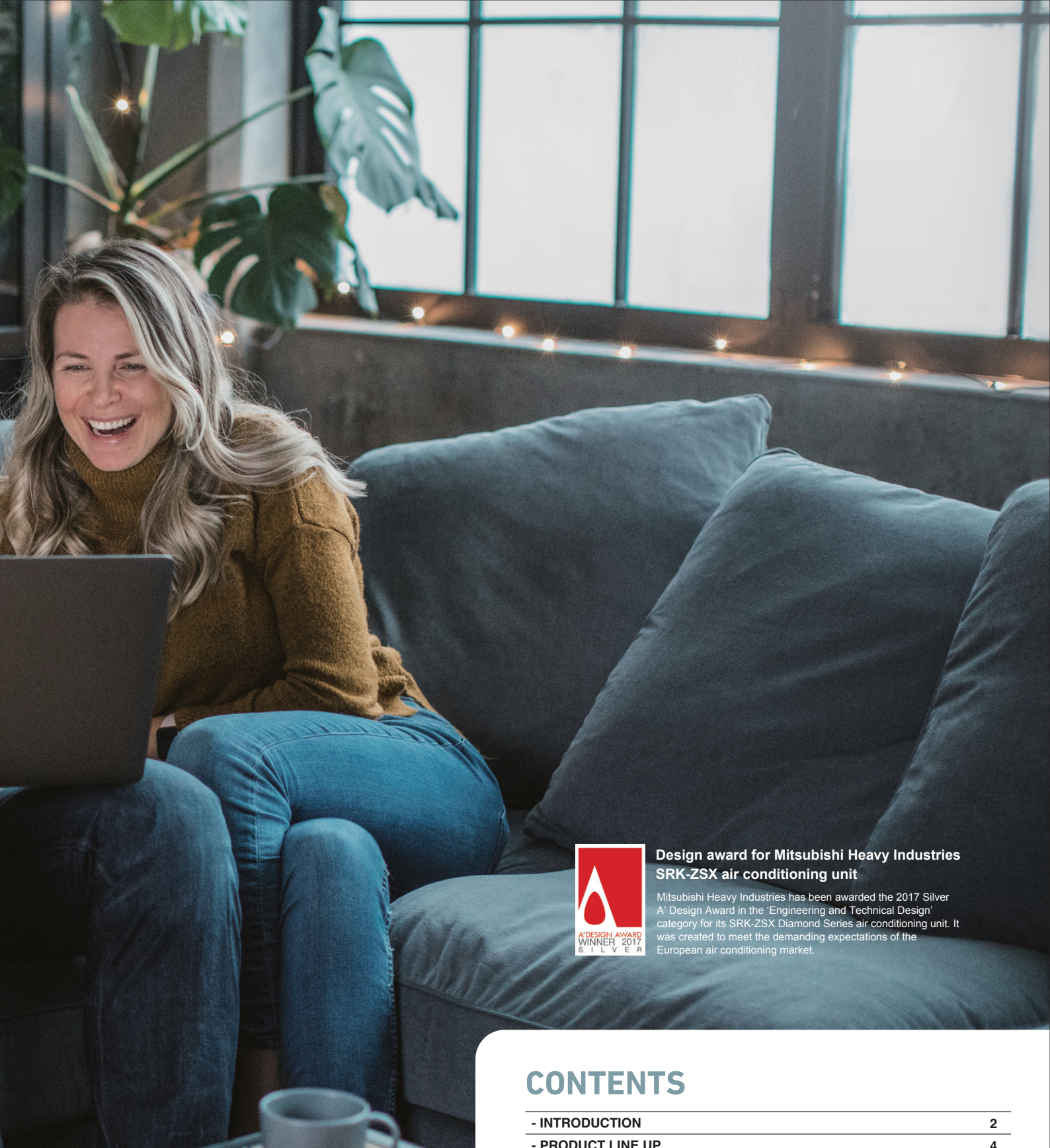

Design award for Mitsubishi Heavy Industries SRK-ZSX air conditioning unit

Mitsubishi Heavy Industries has been awarded the 2017 Silver A' Design Award in the 'Engineering and Technical Design' category for its SRK-ZSX Diamond Series air conditioning unit. It was created to meet the demanding expectations of the European air conditioning market.

Convenience

Control your air conditioner from anywhere, anytime with the optional Wireless Control System.





























CONTENTS

- INTRODUCTION	2
- PRODUCT LINE UP	4
- NEXT GENERATION REFRIGERANT R32	8
- ADVANCED TECHNOLOGY	10
- FUNCTIONS	22
- SINGLE-SPLIT	24
- WALL MOUNTED TYPE	24~32, 36~39
- FLOOR STANDING TYPE	33, 40
- CEILING CONCEALED TYPE	34, 41
- 4WAY CEILING CASSETTE TYPE	35, 42
- MULTI-SPLIT SYSTEM	43
- CONTROL SYSTEM	106
- DIMENSIONS	108
- ENERGY EFFICIENT AND ENVIRONMENTALLY CONSCIOUS	117



















PRODUCT LINE UP

■ SINGLE-SPLIT

Model		Capacity Range (kW : Rated cooling capacity)											
		1.5	2.0	2.5	3.5	4.0	4.5	5.0	6.0	6.3	7.1	8.0	10.0
WALL MOUNTED TYPE	 *1 *2		●	●	●			●	●				
			●	●	●			●	●				
	 *2									●	●	●	●
										●	●	●	●
	 *1 *2		●	●	●			●					
			●	●	●			●					
			●	●	●	●			●		●	●	
													
	 *2				●	●		●	●				
					●	●		●					
	FLOOR STANDING TYPE				●	●			●				
					●	●			●				
CEILING CONCEALED TYPE				●	●			●	●				
				●	●								
CEILING CASSETTE TYPE				●	●	●		●	●				
				●	●	●		●	●				

*1 ZSX, ZS series colour variations available. *2 The photo is for -WF, -W1 type.

■ MULTI-SPLIT SYSTEM

Model (kW)		SCM-ZS-W  P.44								SCM-ZS-S,ZM-S  P.46												
		3.0	4.0	4.5	4.1	5.0	6.0	7.1	8.0	10.0	4.0	4.5	5.0	6.0	7.1	8.0	10.0	12.5				
Number of connectable indoor units		2		2 - 3				2 - 4		2 - 5		2		2 - 3		2 - 4		4 - 5		4 - 6		
Outdoor unit*1		A+++		A+++				A++		A+++		A++		A++		A++		A		*2		
																						
Indoor unit (kW)																						
WALL MOUNTED TYPE	SRK-ZSX-WF, -W 	2.0	•	•		•	•	•	•	•	•	•	•	•	•	•	•	•	•	•		
		2.5	•	•		•	•	•	•	•	•	•	•	•	•	•	•	•	•	•	•	
		3.5	•	•		•	•	•	•	•	•	•	•	•	•	•	•	•	•	•	•	
		5.0				•	•	•	•	•	•			•	•	•	•	•	•	•	•	
		6.0					•	•	•	•	•				•	•	•	•	•	•	•	
	SRK-ZR-WF, -W 	7.1						•	•	•									•	•		
		8.0								•												
	SRK-ZS-WF, -W 	1.5	•			•																
		2.0	•	•	•	•	•	•	•	•	•	•	•	•	•	•	•	•	•	•	•	
		2.5	•	•	•	•	•	•	•	•	•	•	•	•	•	•	•	•	•	•	•	
3.5			•	•	•	•	•	•	•	•	•	•	•	•	•	•	•	•	•	•		
5.0						•	•	•	•	•				•	•	•	•	•	•	•		
SKM-ZSP-W 	1.5	•			•																	
	2.0	•	•	•	•	•	•	•	•	•	•	•	•	•	•	•	•	•	•	•		
	2.5	•	•	•	•	•	•	•	•	•	•	•	•	•	•	•	•	•	•	•		
	3.5		•	•	•	•	•	•	•	•				•	•	•	•	•	•	•		
FLOOR STANDING TYPE	SRF-ZS(X)-W 	2.5	•	•		•	•	•	•	•	•	•	•	•	•	•	•	•	•	•		
		3.5		•	•		•	•	•	•	•	•	•	•	•	•	•	•	•	•	•	
		5.0					•	•	•	•	•			•	•	•	•	•	•	•	•	
CEILING CONCEALED TYPE	SRR-ZS-W 	2.5	•	•		•	•	•	•	•	•	•	•	•	•	•	•	•	•	•	•	
		3.5		•	•		•	•	•	•	•	•	•	•	•	•	•	•	•	•	•	•
		5.0					•	•	•	•	•			•	•	•	•	•	•	•	•	•
		6.0						•	•	•	•				•	•	•	•	•	•	•	•
CEILING CASSETTE TYPE	FDTC-VH 	2.5	•	•		•	•	•	•	•	•	•	•	•	•	•	•	•	•	•	•	
		3.5		•	•		•	•	•	•	•	•	•	•	•	•	•	•	•	•	•	•
		5.0					•	•	•	•	•			•	•	•	•	•	•	•	•	•
		6.0						•	•	•	•				•	•	•	•	•	•	•	•
DUCT CONNECTED TYPE	FDUM-VH 	5.0				•	•	•	•	•			•	•	•	•	•	•	•	•		
CEILING SUSPENDED TYPE	FDE-VH 	5.0				•	•	•	•	•			•	•	•	•	•	•	•	•		

*1 Energy class depends on connected indoor units. *2 Energy label applies below cooling capacity 12kW. *3 Can be also connected colour variation type.

*4 The photo is for -WF type.

ZSX series

For more details go to P24&25 »



White(-WF),
Black & White(-WFB),
Titanium(-WFT)

Luxurious & timeless design

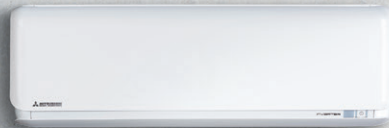
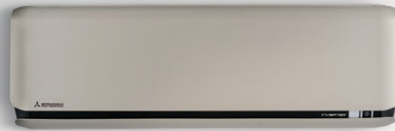

ZSX series White(-WF)



ZS series

For more details go to P28&29 »



White(-WF),
Black & White(-WFB),
Titanium(-WFT)

Sleek & modern design



ZTL series

For more details go to P30 »

Contemporary & compact design



NEXT GENERATION REFRIGERANT R32



All series line up available for R32 refrigerant

R32 is the next generation refrigerant that boasts nearly 70% lower Global Warming Potential Rate than R410A. Due to its superior qualities, R32 offers amazing energy efficiency benefits.

F-GAS REGULATION (EU) No 517/2014

- Introduced in January 2015 to regulate the use of Fluorinated Greenhouse Gases (**F-Gases**)
- The Hydrofluorocarbons (HFCs) are F-Gases used in the HVACR sector (Heating, Ventilation, Air Conditioning and Refrigeration)

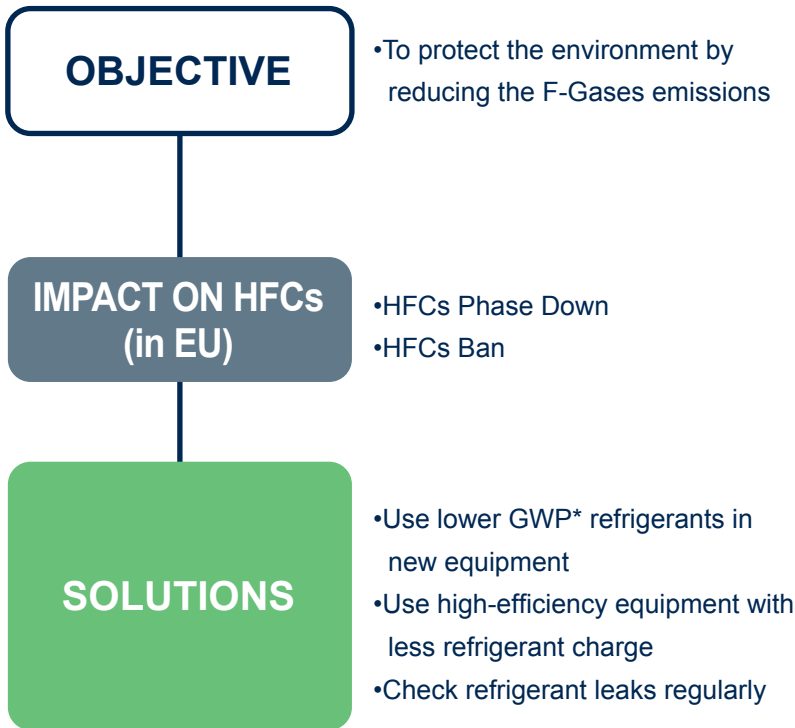
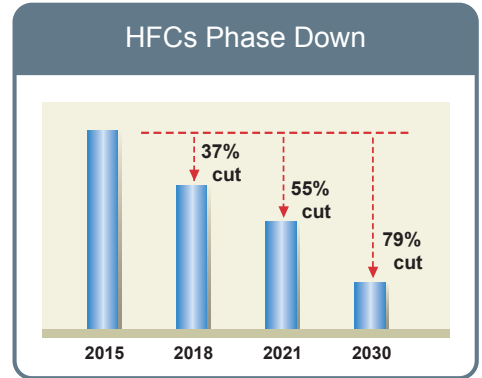

* GWP is the Global Warming Potential of a refrigerant, representing how much heat an **F-Gas** traps in the atmosphere



LOWER GWP + LESS REFRIGERANT CHARGE = LOWER HFCs EMISSIONS

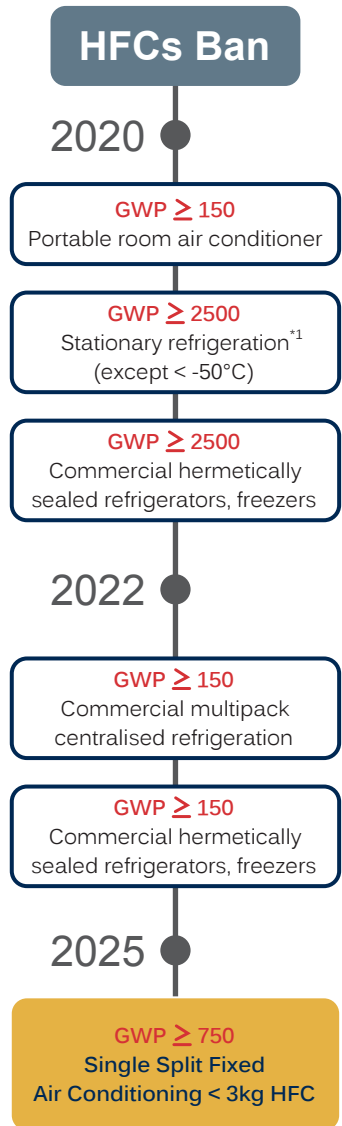

*1 Stationary refrigeration equipment, that contains or relies its functions upon, HFCs with GWP of 2500 or more except equipment intended for application designed to cool products to temperatures below -50°C application

R32 - A Low GWP Refrigerant

- A single component, easy to handle refrigerant
- Known as a component of the blend R410A (50% R32, 50% R125)
- Already used in Air Conditioning systems worldwide
- Zero Ozone Depletion
- Superior Energy Efficiency vs. R410A
- Reduced refrigerant charge vs. R410A
- Easy to recycle

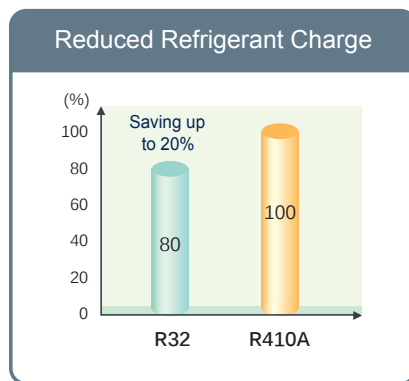
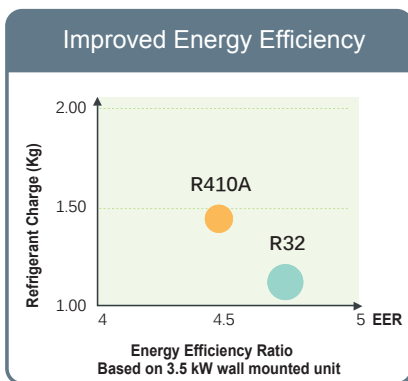
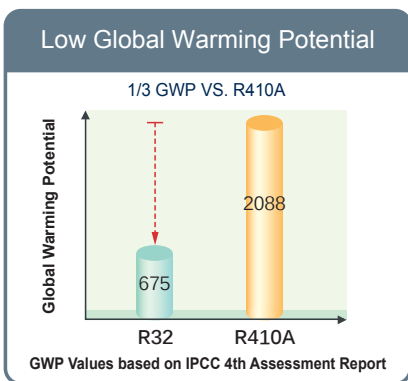
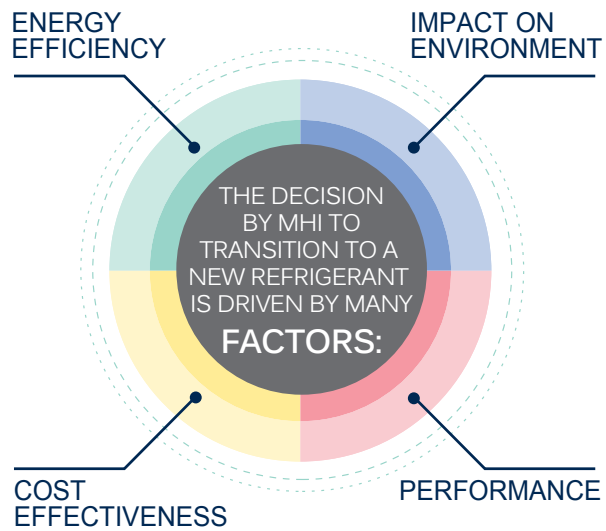
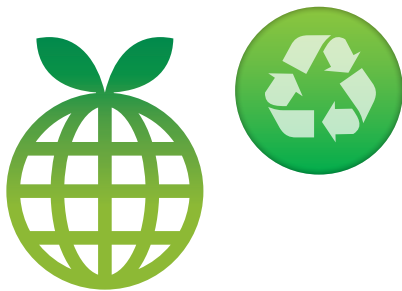

Environmental

Mitsubishi Heavy Industries Thermal Systems are dedicated to facing the challenges of the future and support global sustainability by offering the most energy-efficient air-conditioning systems. Through our in-depth research and development we are able to incorporate new technologies within our units to maximise their energy efficiency and significantly reduce carbon emissions.

Environmental Impact

Mitsubishi Heavy Industries Thermal Systems recognises the importance of reducing carbon emission and selecting environmentally-friendly solutions.

The future of our planet rests in the sustained evolution of humankind while caring, with love and responsibility, for all life forms that inhabit it. Therefore Mitsubishi Heavy Industries Thermal Systems will continue to develop new technologies and products and will remain competitive in the market to achieve a sustainable future.

ADVANCED TECHNOLOGY HIGH EFFICIENCY

Consideration for the Environment

Many design changes and engineering developments have taken place in order to improve the energy efficiencies in our products as well make sure they are environmentally friendly.

High Efficient Performance: Up to Class A⁺⁺⁺

Mitsubishi Heavy Industries Thermal Systems classes its entire range with seasonal domestic energy factors that display energy ratings from A⁺ to A⁺⁺⁺.

Important energy savings in both cooling mode and heating are achieved thanks to its DC PAM Inverter technology and DC twin rotary compressor.

(ZSX series)



Higher Energy class (SEER/SCOP)

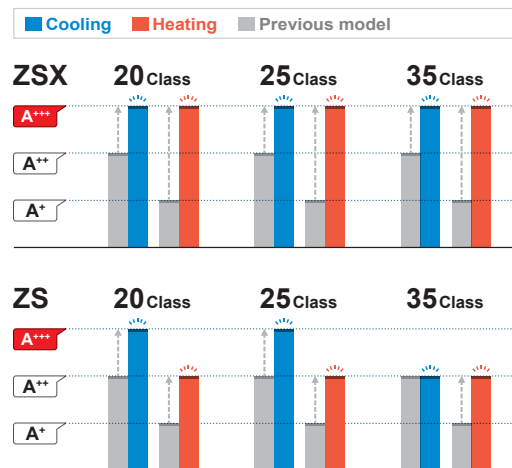

QUICK & HIGH EFFICIENCY Control

DC PAM Inverter

An inverter driven system has a number of performance advantages over a constant speed system. For example, the variable compressor outputs can ensure quick heating after a startup and attain a set temperature more quickly.

The air conditioner can then slow down its compressor speed to save energy, keeping comfortable conditions. Moreover, the compressor is DC driven, so it provides higher performance.



DC compressor motor

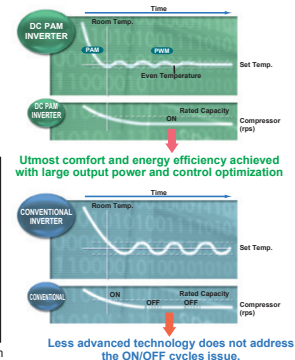
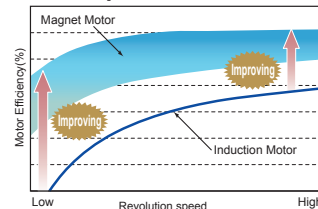

HIGH EFFICIENCY

DC Twin Rotary Compressor

The newly developed DC twin rotary compressor performs highly efficient operation under the wide range conditions from low speed to high speed.

Besides low vibration, low sound level and high efficiency can also be achieved by the optimisation of mechanical parts and by the application of high power Neodymium motor.



Featured on all models of ZSX series

Wide Range of Operation

Our new advanced technology has expanded the heating and cooling operation range.

This permits installation of the units with a heating and cooling operation under a low temperature condition down to -20°C. (ZSX series)

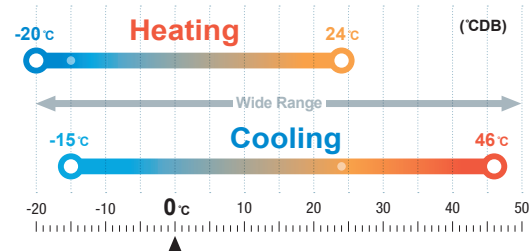

* For the capacities under low temperature conditions, refer to technical manual.

Our Latest Technologies (ZSX series)

[Outdoor unit]

Propeller fan

Optimised matching of the propeller fan and the fan motor in order to keep the same capacity as that of previous models with less electrical consumption. Synergy effect with leaf grill has increased efficiency by 5% and quietened the sound.



Serration fan

Coated PCB

The printed wiring board of the outdoor unit is coated. It lasts longer due to improved tolerance to humidity.

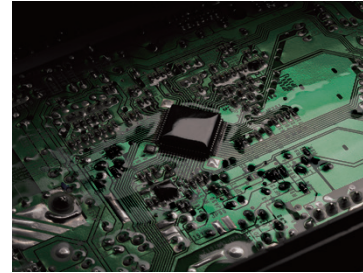

Heat exchanger

By changing fin configuration from flat sheet to M shape fin, efficiency has increased by 10%. This high dimensional structure provides optimum balance of heat transfer and airflow.

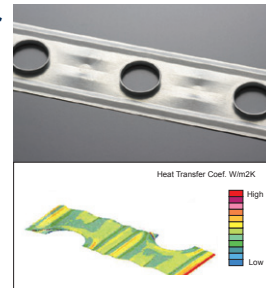

Leaf shape grill

The radial shape grill has been developed in order to send airflow efficiently outside the unit along the grill. Decreasing the load for motor and propeller fan leads to greater energy efficiency and contributes to quieter sound.

Superior corrosion resistance hot dipping steel sheet

Superior corrosion resistance hot dipping steel sheet is applied at the base of outdoor units. It has superior corrosion resistance and scratch resistance properties compared to conventional materials.



DC Motor

DC fan motor produces high efficiency & high power

Three Sensors

Control of room temperature and humidity is very important for people to live a comfortable life. Use of three sensors to control indoor temperature, indoor humidity and outdoor temperature enable unit to obtain optimum air-conditioning.



Sensor for indoor temperature and humidity



Sensor for outdoor temperature

[Indoor unit]

Heat exchanger

Our optimal combination of fin configuration and copper tube has maximised airflow volume without expanding indoor unit's size in width. Compared with previous models, the heat exchanger efficiency rate has drastically improved by 33%. The fin can maximise airflow volume and save energy simultaneously.

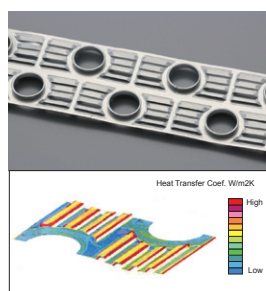

Movable air inlet panel

Minimisation of air resistance is achieved by incorporating a movable air inlet panel of advanced design.



* This page is mainly described ZSX series.

AIR FLOW

Jet Air Technology Quiet Air Flow & Long Reach

We used the same aerodynamic analysis technology as used in developing jet engines.



CFD (computational fluid dynamics) used in blade shape design of jet engines, has been applied to the design of air channels in air conditioners to develop the ideal air channel system (air circulation). The jet air stream generated by this air channel system can bring large volumes of air without consuming a great amount of power. While at the same time, it delivers a consistent breeze evenly throughout the room.

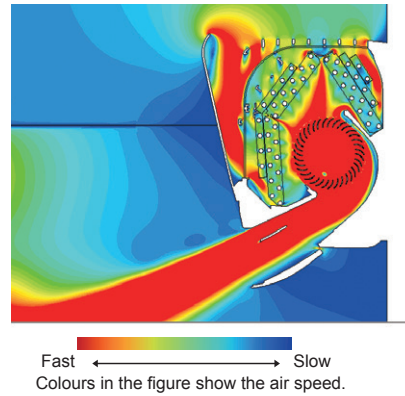
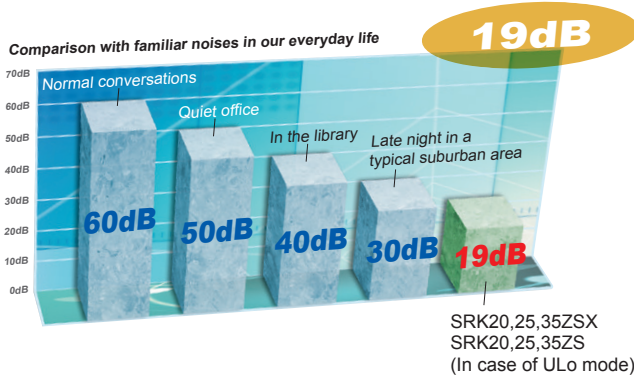

Long Reach Air Flow

Long reach air flow is achieved by jet air technology. Good for large living rooms and shops, which increases comfort.



Double Flap Large and Small

Comfort temperature is achieved by using the double flap system which optimises the air flow. This is also capable of producing horizontal and long reaching air flow in cooling operation, and strong and downward air flow in heating operation.





3D AUTO Vertical + Horizontal

Multi motors make 3 independent controls

3D AUTO is one touch programmed and multi motors make three independent air flow controls. The uniform and quiet airflow can be delivered to every corner of the room, achieving economical operation and minimising energy loss.

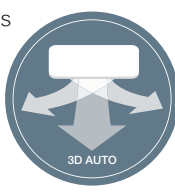

By using automatic control functions allows for comfortable air conditioning consistently achieved throughout the room. Comfort cooled air flow comes via the ceiling like a cool breeze. In the heating mode, warm air flow can be sent down to the floor directly. The warm air then spreads along the floor achieving optimum comfort.

Programmed 3D AUTO

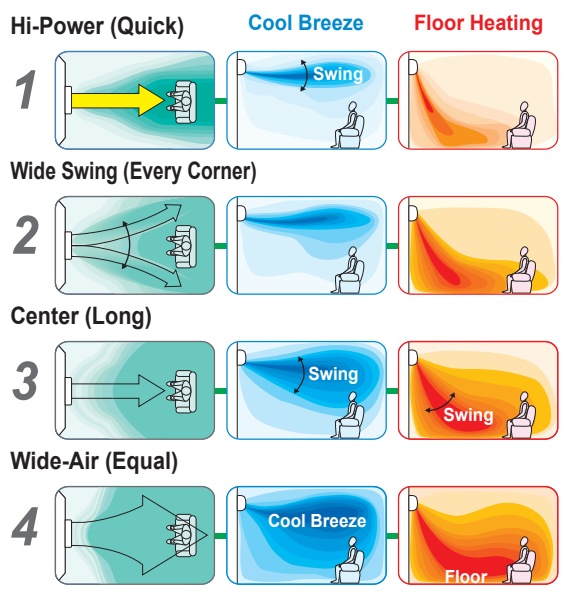

Horizontal swings in 8 directions

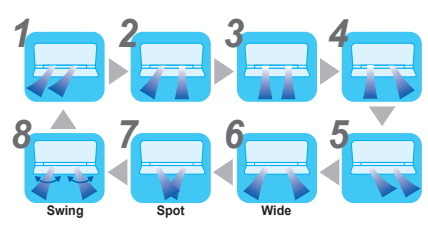

The airflow direction from the right and left louvers can be controlled individually. Eight different air flow patterns can be selected.

* This page is mainly described ZSX series.

CLEAN AIR

This is the original technology to control the temperature and humidity for inactivating allergens

Allergen Clear Operation

This can be activated by pressing the "allergen" button on the remote control and lasts 90 minutes before stopping automatically. It neutralises the bacteria collected on the surface of the anti-allergenic filter thanks to its sophisticated interaction between temperature and humidity controls.

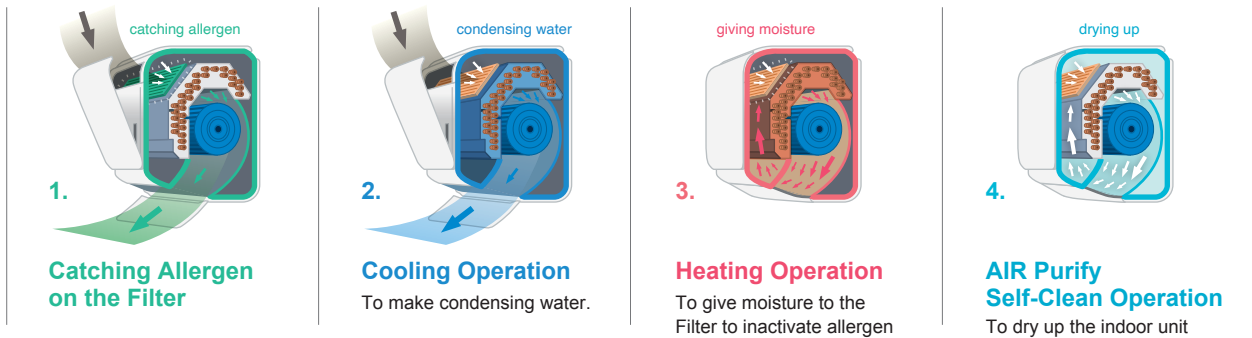

Self Clean Operation

Self clean operation works for 2 hours after the unit has stopped its normal operation. The indoor unit is dried up and the growth of mold is restrained. Users can select whether this mode is utilized or not.

Situation of mold after one week

When you don't execute "Self Clean Operation"



When you execute "Self Clean Operation"

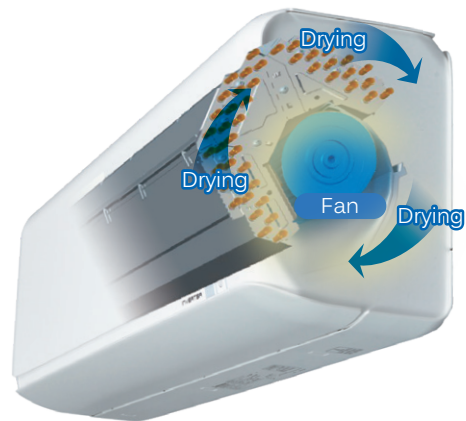
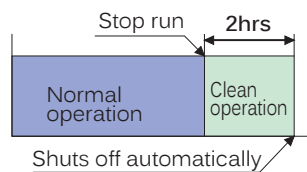
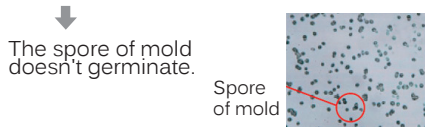

Allergen Clear Filter

Enzyme + Urea deactivates allergens and bacteria.



The allergen clear filter breaks down the pollen^{*1}, lice^{*1}, and allergens that live on cat skins, etc. and deactivates them. The secret of deactivation is the Enzyme-urea compound. It deactivates not only allergens but also all kinds of bacteria^{*2}, molds and viruses^{*3}. Even if allergens and bacteria, etc. fly of the filter, they are deactivated, so the air in your room is kept fresh.

*1 Test method: ELISA colorimetric method Laboratory: Independent administrative agency national hospital mechanism Sagamihara Hospital, No.1536

*2 Test method: ELISA colorimetric method / ELISA fluorescent method Laboratory: Independent administrative agency national hospital mechanism Sagamihara Hospital, No.1536

*3 Test method: TCID (Infection value 50%) Laboratory: Foundation of Kitazato Environmental Science Center, No.15-0145

Structure of Preventing Dirt

Always keeping the indoor unit clean

The fan has undergone anti-microbial treatment to resist mold and germs, making the system clean and safe. This prevents foul odours, molds, etc. which can occur when an air conditioning system is not in operation.

(Compatible with all wall mounted type units.)

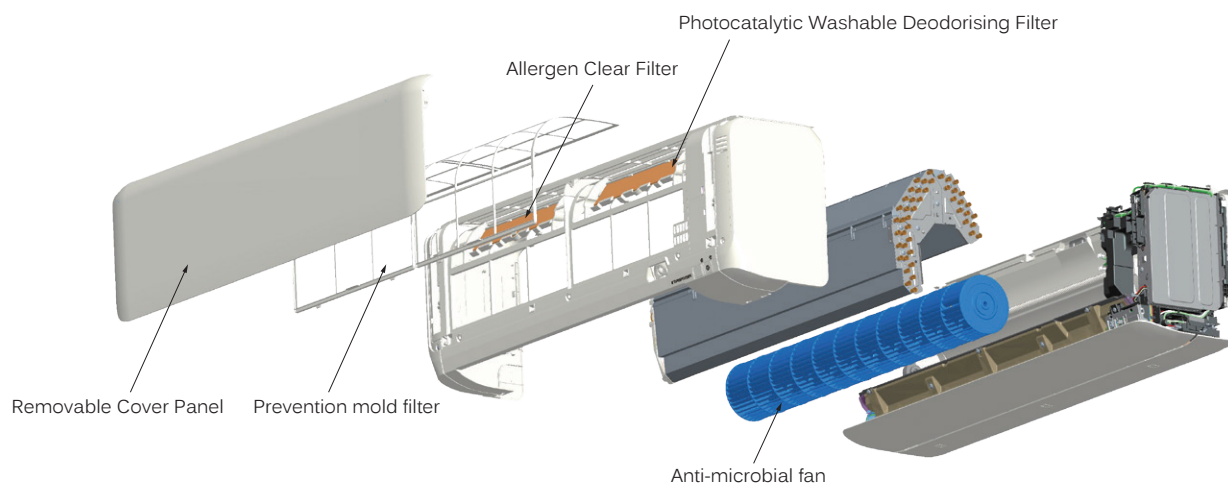

• Efficacy of "Anti-microbial"

Testing Authority: Japan Food Analysis Center

Test Report No. : 17067139001 - 0301

JIS Z 2801 Antimicrobial Products - Test for Antimicrobial Activity and Efficacy

Test Report No. : 17067139001 - 0501

JIS Z 2911 Methods of Test for Fungus Resistance

Tests were conducted with reference to the antimicrobial strength tests as follows Delere.

without Anti-microbial with Anti-microbial

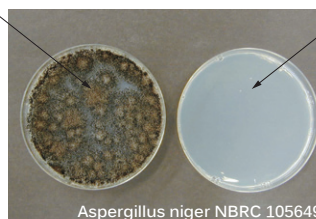

Comparison of growth of bacteria and mold on fan surfaces (microscopic image)

Tests conducted at the Mitsubishi Heavy Industries Nagoya Research Lab, 24 hours after contact with bacteria, cultured on agar media.

Photocatalytic Washable Deodorising Filter

The deodorising power can be restored by washing with water and drying in the sun, as such it is a recyclable deodorising filter capable of repeat use.

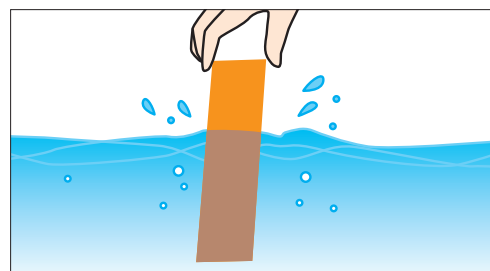
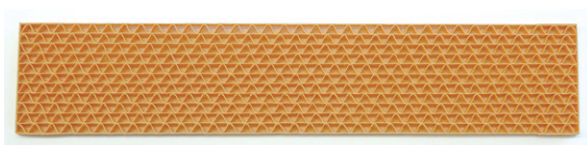

Used in models

Filter	Indoor Unit	SRK-ZSX	SRK-ZR	SRK-ZS	SRK-ZTL
Allergen Clear Filter		1pc	1pc	1pc	1pc
Photocatalytic Washable Deodorising Filter		1pc	1pc	1pc	-

* This page is mainly described ZSX series.

ENERGY SAVING / COMFORT



Eco Operation

Automatic energy saving control is done by detecting human activity. Human activity is detected by a motion sensor which is installed in the unit. Air conditioner adjusts its cooling/heating capacity according to low/high demand. Economy Cooling operation : air conditioner goes into energy saving control when low activity is detected. Economy Heating operation : air conditioner goes into energy saving control when high activity is detected. When the sensor detects that no one is present in the room, the unit will automatically reduce the power used to a moderate level after approximately 15 minutes and return to normal operation once people return to the room.

In a cooling operation

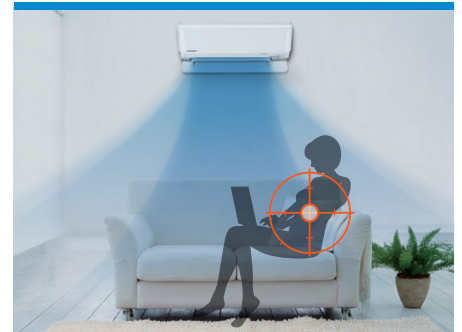

It is set to moderate operation when there is little movement in the room.

In a heating operation



It is set to moderate operation when there is a volume of movement in the room.

Auto Off

Air conditioner stops operation and goes to "stand-by" mode after 1-hour absence. It turns ON again when human activity is detected within 12-hours, or turns OFF after a 12-hours absence. *Can also be set to turn OFF after two hours.

Absent



It suppresses the power when there is nobody present in the room.

After 1-hour



Stand-by

You do not need to worry, even if you forget to turn off the power. Air conditioner stops until human activity is detected.

Come back to room



Normal operation turns ON again

Automatically operates in the preset mode if you return to the room within twelve hours.

Fuzzy Auto Mode

The temperature and humidity sensors check room conditions. The unit automatically controls the operation mode and the setting temperature to operate efficiently. Operation mode and cooling/heating capacity is controlled automatically according to one setting temperature. Fuzzy auto mode offers automatic comfort temperature control even if weather condition changes quickly.



High Power Operation

In a cooling operation

This operation mode delivers powerful cool air to cool the room quickly.

It blows powerful cool air when you want to be cooled down after bathing or returning home on a hot summer day so that you can enjoy a cool sensation immediately. The air conditioner automatically returns to the previous operation mode in 15 minutes to prevent the room from being cooled excessively.

In a heating operation

This operation mode warms the whole room from the vicinity of the air conditioner to your feet.

It warms up the room promptly when you want to be warmed after getting out of bed or returning home during the winter season. The air conditioner automatically returns to the previous operation mode in 15 minutes to prevent the room from being warmed excessively.

Silent Operation

When silent operation is set, the maximum pressure level of the outdoor unit will be 3dB(A) lower than standard nominal level (45dB(A) or less).

The compressor speed is set at a lower range than that of nominal operation, operating at 60% of nominal capacity.

Maximum fan speed of outdoor unit is set lower than nominal operation.



Night Setback

During cold seasons, room temperatures can be maintained at a comfortable level even while the room is unattended.

The air conditioner keeps the temperature at 10°C.



Fireplace Function

By continuing to operate the indoor fan when the room temperature is stabilized, the warm air accumulated in the ceiling is circulated to the room.

* This page is mainly described ZSX series.

TIMER / CONVENIENCE

Weekly Timer

Up to 4 programs with timer operation (ON-TIMER / OFF-TIMER) are available for each day of the week. Maximum 28 programs per week can be set. Once set, the timer operation will repeat the same program every week unless otherwise cancelled.

Sleep Timer

Too much cooling/heating is not necessary when people go to sleep. This function achieves moderate cooling/heating by adjusting its capacity and saving more energy as well.

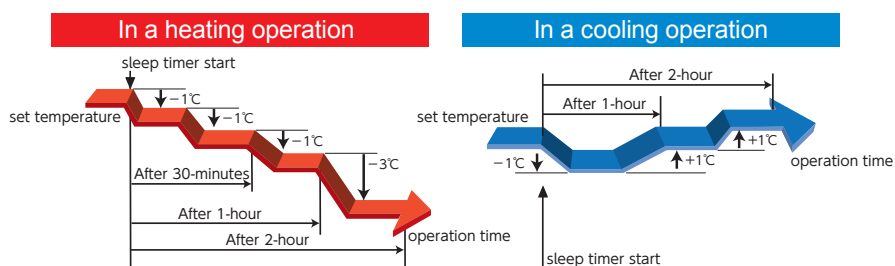

Comfort start-up

Air conditioner controls room temperature to achieve comfort at the "set time" by 60-minutes pre-operation. This is convenient when you wake up or return home at a predetermined time. In ON-TIMER operation, the unit starts the operation a little earlier, so that the room can approach optimum temperature at ON time.

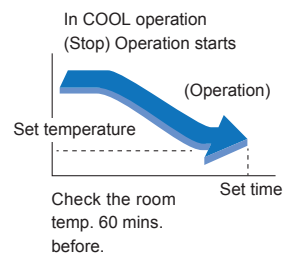

Preset Operation

The preset operation features allow customised temperature and airflow settings, which will deliver ultimate comfort with one simple touch of the button. (Applied for ZSX, ZS, ZTL series)

LED Brightness Adjustment

Brightness of the LED display can be adjusted according to the user's preference. (Applied for ZSX, ZS, ZTL series)



Long Piping Length

ZSX series supports a piping length of up to 30m to give design flexibility.

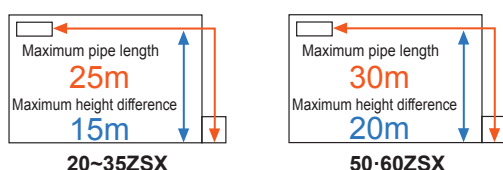

Installation of air conditioners for a three-story house is available with long piping length

Suitable installation space can be found easily for outdoor units with long piping length. As one outdoor unit is necessary for a three-story house the space required for installation is relatively small so the unit can be obscured in place. Indoor units can be installed far apart such as on the first floor and the third floor.

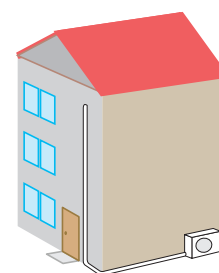

WIRELESS CONTROL SYSTEM



**Control your
air conditioner
from anywhere,
anytime**

If you turn on the air conditioner when you're on the go, you'll be comfortable when you get home. Even if you forget to turn it off, you can turn it off when you are out and about.

Wireless Control System

You can control the air conditioner at home or on the go by installing Smart M-Air app on your smartphone or tablet.



Search for "Smart M-Air" from the GooglePlay™ store for Android™ and AppStore for iPhone.



Application compatible model: Android™ OS 8-13 smartphones and tablets, iPhone for iOS 12-16

Functions

- 1 Turn ON/OFF
- 2 Change operation mode (Cool, Heat, Dry, Auto)
- 3 Control temperature
- 4 Set Timers
- 5 Favourite setting

Notification Function

- 1 Shut-off reminder alert
A notification will be sent to your smart device if the air conditioner is accidentally left running
- 2 Hi temp / low temp alert
- 3 Home Leave Mode
- 4 Watching function

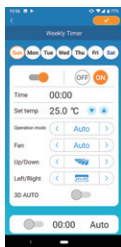

Weekly Timer

Timers can be set for different days of the week. They can also be set from the calendar.

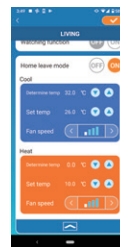

Home Leave Mode

Heating / Cooling operation is automatically turned on when the room temperature is lower or higher than the set temperature.



Vacant Property Mode

Temperature can be set as follows:
Cooling 31°C to 33°C (interval 1°C),
Heating 10°C to 17°C (interval 1°C)
Only "Cool" and "Heat" operation modes can be selected.

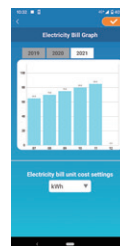

Electricity Bill Graph

Displays an electricity bill by month on a graph.
You can also set the electricity unit cost.

Wireless LAN Built-in model

Wireless Control System is equipped as standard

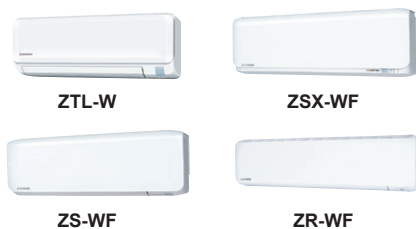

Applicable products

Built-in

- 1 SRK-ZSX -WF/WFB/WFT
- 2 SRK-ZR -WF
- 3 SRK-ZS -WF/WFB/WFT
- 4 SRK-ZTL -W

Optional

- 1 SRK-ZSX -W/WB/WT/-S
- 2 SRK-ZR -W/-S
- 3 SRK-ZS -W/WB/WT
- 4 SRK-ZS -S/-SB/-ST



Now available in

Amazon Alexa™

Voice control function

By using the Smart M-Air app and a commercially available smart speaker the user can operate the MHI air conditioners with the voice control function.

Now available in

Google Assistant™

Functions

- 1 Air conditioner ON/OFF
- 2 Changing operating mode (auto/cool/heat)
- 3 Change set temperature
- 4 Checking operating condition of air conditioner
- 5 Detect (*1*2*3) air conditioner, etc.



Smart Speaker

Functions

- 1 Air conditioner ON/OFF
- 2 Changing operating mode (auto/cool/heat/fan/dry)
- 3 Change set temperature
- 4 Checking operating condition of air conditioner
- 5 Synchronize (*1*2*3) air conditioner, etc.

Voice command example for Amazon Alexa™*4

Air conditioner operation	Voice command example
Start operation (Stop)	Alexa, turn on the "LIVING ROOM" (turn off)
Turn on cooling (Turn on heating)	Alexa, set the "LIVING ROOM" to cool (to heat)
Increase the temperature by 1 degree Celsius (Lower)	Alexa, increase the temperature in the "LIVING ROOM" (lower)
Increase the temperature by 2 degrees Celsius (Lower)	Alexa, increase the temperature in the "LIVING ROOM" by 2 degrees (lower)
Set temperature to 24 degrees Celsius	Alexa, set the "LIVING ROOM" temperature to 24 degrees
Respond with the operating mode	Alexa, tell me the operating mode of the "LIVING ROOM"

Air conditioner operation	Voice command example
Respond with the set temperature	Alexa, what degrees is the "LIVING ROOM" set to
Respond with the room temperature	Alexa, what is the "LIVING ROOM" temperature
Detect added air conditioners	Alexa, detect device

*1 Air-conditioners added or removed by the Smart M-Air smartphone application can now be used on smart speaker.
 *2 Support function may be expanded in the future. For the latest support, go to the Smart M-Air skill overview page in the smart speaker settings application.
 *3 An example of voice command is when you set the air conditioner name to "LIVING ROOM" in the "Smart M-Air" smartphone application or the smart speaker setting application. Replace " " with the name of the air conditioner you set.
 *4 For the voice command example for Google Assistant™ Please refer to our manuals

- The voice control function is available in selected countries. For more details please check with your installer for availability.
- For some models, the wireless control system may not be applicable.

System configuration

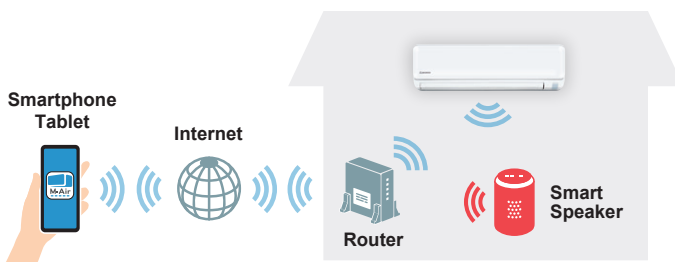

Model :WF-RAC



* For the units that does not include wireless LAN the function could be used by adopting an option (WF-RAC)

NOTE

App Store and iPhone are registered trademark of Apple Inc. Google Play and the Google Play logo are trademarks of Google LLC.

Amazon, Echo, and Alexa are trademarks of Amazon.com, Inc or its affiliates.

Google, Google Home, Android, Google Play, Google Assistant, and Google Nest are trademarks of Google LLC.

Other company and product names mentioned are trademarks or registered trademarks of their respective companies.

*SC-BIKN2-E cannot be used simultaneously for system configuration.

FUNCTIONS

Energy saving



Fuzzy Auto Mode

Using fuzzy logic algorithms, the unit determines the operating mode and temperature settings automatically and adjusts the inverter frequency.



Motion Sensor

This sensor detects human activity and shifts the temperature setting according to the amount of activity in the room.



Eco Operation

Room temperature and humidity are monitored using a sensor to automatically control the operation. In tandem with the motion sensor, the system enables an energy saving mode while maintaining comfort.



Auto Off

Stops the operation automatically when there is no activity detected in the room for a certain period.



Economy Mode

The unit will operate in energy saving mode in order to avoid excessive heating and cooling.

Air flow



Jet Air Technology

Air flow is regulated using the same blade technology as that in jet engines which produces a powerful yet efficient air flow.



3D Auto

This one touch program will activate the three independent motors to evenly distribute air flow and create optimum heating and cooling conditions.



Auto Flap Mode

Depending on the operating mode, the unit will automatically set the position of the louvers at the optimal angle.



Memory Louver

While the louver is swinging it can be stopped at any angle. On the next start-up the louver returns to the same position that it was when the operation last stopped.



Vertical Auto Swing

Louvers swing up and down continuously and can be set at a fixed angle.



Horizontal Auto Swing

Louvers swing right and left continuously and can be set at a fixed angle.



Draft Prevention Setting

Draft Prevention setting provides a comfortable air flow without any draft feeling. Whether cooling or heating a room, the remote control can be used to instantly suppress any warm or cool drafts. This accurately assists how air flow is directed out of the indoor unit.

Clean Operation & Filter



Allergen Clear Operation

The system is equipped to suppress the influence of the allergens caught by the Allergen Clear Filter by controlling the temperature and humidity. Enzymes are used to suppress the influence of the allergens caught during everyday operation.



Self-Clean Operation

Self clean mode dries the indoor unit and filter, preventing the growth of mould. This runs for 2 hours after the unit has been switched off.



Allergen Clear Filter

The filter breaks down the pollen, lice, and all allergens that live on cat skins, etc. and deactivates them.



Photocatalytic Washable Deodorising Filter

This easy to clean filter that catches airborne allergens and particles before neutralising odour causing bacteria within them.



Removable Cover Panel

With an easy to remove front panel, cleaning and maintenance of the indoor unit is quicker and easier than ever.

Comfort



Dry Operation

During dry operation the unit will act as a dehumidifier to remove moisture from the air.



High Power Operation

Use the high power function to quickly reach your optimum temperature level when you first turn on the unit. This function will operate for a maximum of 15 minutes before returning to normal operation.



Silent Operation

This function allows you to program periods where the unit will operate with reduced noise levels and is ideal for temperature control during the night.



Night Setback

Designed for cold season, this ensures the room temperature is kept at around 10°C, even while unoccupied.



Fireplace Function

By continuing to operate the indoor fan when the room temperature is stabilized, the warm air accumulated in the ceiling is circulated to the room.

Timer



Weekly Timer

Set your unit to turn on and off automatically on a weekly basis to suit your usual room usage on each day.



24-hour On/Off Programmable Timer

By combining a start timer with a stop timer, you can register two timer operations a day. Once set, timers will faithfully start or stop the system at a specified time of the day repeatedly.



Sleep Timer

The room temperature is automatically controlled during the set sleep mode period, ensuring that room temperature will not get too cold or too hot. Set a predetermined amount of time between 30 and 240 minutes that your unit will operate for before switching off.



On/Off Timer

This timer allows the unit to be set to turn ON or OFF automatically once within a 24 hour period.

Convenience



Comfort Start-up

With the ON-TIMER function, the unit will switch on earlier than the SET time, to ensure the optimum temperature is reached at the ON TIME.



Preset Operation

The desired preset operation mode can be enabled with a single touch of a button.



Child Lock

Lock the remote control to prevent child from tampering with the remote control.



LED Brightness Adjustment

The unit has an adjustable LED brightness display for minimal disturbance during night operation.



Positioning of Installation

This allows you to manually set the air flow direction when the unit is installed against a wall.



Wireless Control System

If you acquired the Wireless device, you can control the air conditioner at home or on the go by installing Smart M-Air app on your smartphone or tablet.

Others



Microcomputer-Operated Defrosting

This mode is automatically activated during low ambient temperatures to prevent the frosting of the outdoor heat exchanger and maintains heating efficiency.



Self Diagnostics

The internal microcomputer automatically runs a diagnostic of the system in the event of a malfunction. This enables your authorised dealer to isolate and repair any issues.



Auto Restart Function

If there is a temporary loss of power, when power is restored, the unit will automatically restart in the same operating mode it was in.



Back-up Switch

If the remote control fails, the unit can be operated via an on/off switch on the indoor unit.

		ZSX	ZR	ZS	ZTL	ZSP	SRF	SRR	FDTC ³	SKM	FDUM ³	FDE ³
Energy saving	Fuzzy Auto Mode	●	●	●	●	●	●	●	●	●	●	●
	Motion Sensor	●						● ^{*4} option		● option	● option	
	Eco Operation	●						● ^{*4} option		● option	● option	
	Auto Off	●						● ^{*4} option		● option	● option	
	Economy Mode		●	●	●	●	●	●		●		
Air flow	Jet Air Technology	●	●	●	●	●			●			
	3D Auto	●	●	●	●							
	Auto Flap Mode	●	●	●	●	●	●		●	●		●
	Memory Louver	●	●	●	●	●	●		●	●		●
	Vertical Auto Swing	●	●	●	●	●	●		●	●		●
	Horizontal Auto Swing	●	●	●	●							
	Draft Prevention Setting								● ^{*4} option			
Clean operation & Filter	Allergen Clear Operation ^{*1}	●	●	●	●							
	Self Clean Operation	●	●	●	●	●	●		●			
	Allergen Clear Filter	●	●	●	●		●					
	Photocatalytic Washable Deodorising Filter	●	●	●			●					
	Removable Cover Panel	●	●	●	●	●	●					
Comfort	Dry Operation	●	●	●	●	●	●	●	●	●	●	●
	High Power Operation	●	●	●	●	●	●	●	●	●	●	●
	Silent Operation ^{*2}	●	●	●	●		●	●				
	Night Setback	●	●	●	●		●	●				
	Fireplace Function	●		●	●							
Timer	Weekly Timer	●	●	●	● ^{*5}		●	●	●		●	●
	24-hour On/Off Programmable Timer				●	●				●		
	Sleep Timer	●	●	●	●	●	●	●	●	●	●	●
	On/Off Timer	●	●	●	●	●	●	●	●	●	●	●
Convenience	Comfort Start-up	●	●	●	●	●	●	●	●	●	●	●
	Preset Operation	●		●	●		●	●				
	Child Lock	●	●	●	●		●	●				
	LED Brightness Adjustment	●		●	●							
	Positioning of Installation	●	●	●	●							
	Wireless Control System	● ^{*6}	● ^{*6}	● ^{*6}	●							
Others	Microcomputer-Operated Defrosting	●	●	●	●	●	●	●	●	●	●	●
	Self-Diagnostic Function	●	●	●	●	●	●	●	●	●	●	●
	Auto Restart Function	●	●	●	●	●	●	●	●	●	●	●
	Back-up Switch	●	●	●	●	●	●	●		●		

^{*1} In case of Multi-split system, is not available. ^{*2} It can not be used for SCM40 • 45ZS-S, SCM100 • 125ZM-S. ^{*3} When using wired remote control (RC-EX3A). ^{*4} FDTC-VH only ^{*5} For the ZTL series, the "Weekly Timer" function could only be used from the application Smart M-air. ^{*6} -W, -S type would need an option to use the wireless function.



SINGLE-SPLIT WALL MOUNTED TYPE



SRK-ZSX-WF



SRK20ZSX-WF, SRK25ZSX-WF, SRK35ZSX-WF, SRK50ZSX-WF, SRK60ZSX-WF Pure White(-WF)



Black & White(-WFB)



Titanium(-WFT)



A+ DESIGN AWARD WINNER 2017 SILVER



BUILT IN WIRELESS LAN



Wireless remote control



SRC20ZSX-W, SRC25ZSX-W, SRC35ZSX-W, SRC50ZSX-W2, -W3, SRC60ZSX-W1, -W3

KEY FEATURES

- ZSX series with the "Elegant Timeless Design" is best suited for small to medium sized living spaces
- High Seasonal efficiency performance is up to A+++ in cooling and heating
- Low Global Warming Potential (GWP) and High energy efficiency by new refrigerant R32
- Quiet Air Flow & Long Reach is achieved by jet technology
- Colour variation available. Users can choose from three different choices
- Wireless interface control included

*SC-BIKN2-E cannot be used simultaneously with the Wireless LAN control system

SPECIFICATIONS

Indoor unit			SRK20ZSX-WF,-WFB,-WFT	SRK25ZSX-WF,-WFB,-WFT	SRK35ZSX-WF,-WFB,-WFT	SRK50ZSX-WF,-WFB,-WFT	SRK60ZSX-WF,-WFB,-WFT
Outdoor unit			SRC20ZSX-W	SRC25ZSX-W	SRC35ZSX-W	SRC50ZSX-W2,-W3	SRC60ZSX-W1,-W3
Power source			1Phase, 220 - 240V, 50Hz				
Nominal cooling capacity (Min~Max)		kW	2.0 (0.9~3.4)	2.5 (0.9~3.8)	3.5 (0.9~4.5)	5.0 (1.0~6.2)	6.1 (1.0~6.9)
Nominal heating capacity (Min~Max)		kW	2.7 (0.8~5.5)	3.2 (0.8~6.0)	4.3 (0.8~6.8)	6.0 (0.8~8.2)	6.8 (0.8~8.8)
Power consumption		Cooling/Heating kW	0.31 / 0.47	0.44 / 0.59	0.74 / 0.90	1.24 / 1.36	1.71 / 1.65
EER/COP		Cooling/Heating	6.45 / 5.74	5.68 / 5.42	4.73 / 4.78	4.03 / 4.41	3.57 / 4.12
Max. running current		A	9	9	9	15	15
Sound power level	Indoor	Cooling/Heating	53 / 55	55 / 56	58 / 58	59 / 62	62 / 63
	Outdoor	Cooling/Heating	56 / 58	57 / 58	61 / 62	63 / 61	65 / 64
Sound pressure level	Indoor	Cooling (Hi/Me/Lo/Ulo)	38 / 31 / 24 / 19	39 / 33 / 25 / 19	43 / 35 / 26 / 19	44 / 39 / 31 / 22	48 / 41 / 33 / 22
		Heating (Hi/Me/Lo/Ulo)	38 / 33 / 25 / 19	40 / 34 / 27 / 19	42 / 35 / 28 / 19	47 / 41 / 33 / 23	47 / 42 / 34 / 23
	Outdoor	Cooling/Heating	43 / 45	44 / 45	48 / 47	51 / 49	52 / 53
Air flow	Indoor	Cooling (Hi/Me/Lo/Ulo)	11.3 / 9.1 / 6.0 / 5.0	12.2 / 10.0 / 6.7 / 5.0	13.1 / 10.8 / 7.3 / 5.0	14.3 / 12.4 / 7.8 / 5.4	16.3 / 13.4 / 8.9 / 5.4
		Heating (Hi/Me/Lo/Ulo)	12.2 / 10.3 / 7.2 / 5.4	12.8 / 11.0 / 7.8 / 5.4	13.9 / 11.8 / 8.6 / 5.4	17.3 / 14.3 / 9.8 / 6.2	17.8 / 13.7 / 10.9 / 6.2
	Outdoor	Cooling/Heating	31.0 / 31.0	31.0 / 31.0	36.0 / 31.0	39.0 / 33.0	41.5 / 39.0
Exterior dimensions	Indoor	HeightxWidthxDepth	305 x 920 x 220				
	Outdoor		640 x 800(+71) x 290				
Net weight		Indoor / Outdoor	13.0 / 43.0			13.0 / 45.0	
Refrigerant		Type/GWP	R32 / 675				
		Charge	1.20 / 0.810			1.30 / 0.878	
Refrigerant piping size		Liquid/Gas	6.35(1/4") / 9.52(3/8")			6.35(1/4") / 12.7(1/2")	
Refrigerant line (one way) length [chargeless length]		m	Max.25 [15]				
Vertical height differences		Outdoor is higher/lower	Max.15 / Max.15			Max.20 / Max.20	
Outdoor operating temperature range		Cooling	-15~46				
		Heating	-20~24				
Clean filter			Allergen Clear Filter x 1, Photocatalytic Washable Deodorising Filter x 1				

* The data are measured under the following conditions(ISO-T1, H1). Cooling: Indoor temp. of 27°CDB, 19°CWB, and outdoor temp. of 35°CDB. Heating: Indoor temp. of 20°CDB, and outdoor temp. of 7°CDB, 6°CWB.

* Sound level indicates the value in an anechoic chamber. During operation these values are somewhat higher due to ambient conditions.

* 'tonne(s) of CO₂ equivalent' means a quantity of greenhouse gases- expressed as the product of the weight of the greenhouse gases in metric tonnes and of their global warming potential.



SINGLE-SPLIT WALL MOUNTED TYPE



SRK-ZSX-W



SRK20ZSX-W, SRK25ZSX-W, SRK35ZSX-W
SRK50ZSX-W, SRK60ZSX-W



OPTIONAL



Wireless remote control



SRC20ZSX-W, SRC25ZSX-W,
SRC35ZSX-W, SRC50ZSX-W2, -W3
SRC60ZSX-W1, -W3

KEY FEATURES

- ZSX series with the "Elegant Timeless Design" is best suited for small to medium sized living spaces
- High Seasonal efficiency performance is up to A+++ in cooling and heating
- Low Global Warming Potential (GWP) and High energy efficiency by new refrigerant R32
- Quiet Air Flow & Long Reach is achieved by jet technology
- Allergen clear operation cleans air, using a control scheme owned only by Mitsubishi Heavy Industries Thermal Systems
- Wireless interface control (optional)

SPECIFICATIONS

Indoor unit			SRK20ZSX-W	SRK25ZSX-W	SRK35ZSX-W	SRK50ZSX-W	SRK60ZSX-W				
Outdoor unit			SRC20ZSX-W	SRC25ZSX-W	SRC35ZSX-W	SRC50ZSX-W2, -W3	SRC60ZSX-W1, -W3				
Power source			1Phase, 220 - 240V, 50Hz								
Nominal cooling capacity (Min~Max)		kW	2.0 (0.9~3.4)	2.5 (0.9~3.8)	3.5 (0.9~4.5)	5.0 (1.0~6.2)	6.1 (1.0~6.9)				
Nominal heating capacity (Min~Max)		kW	2.7 (0.8~5.5)	3.2 (0.8~6.0)	4.3 (0.8~6.8)	6.0 (0.8~8.2)	6.8 (0.8~8.8)				
Power consumption		kW	Cooling/Heating		Cooling/Heating		Cooling/Heating				
EER/COP			0.31 / 0.47	0.44 / 0.59	0.74 / 0.90	1.24 / 1.36	1.71 / 1.65	6.45 / 5.74	5.68 / 5.42	4.73 / 4.78	4.03 / 4.41
Max. running current		A	9	9	9	15	15				
Sound power level	Indoor	Cooling/Heating	53 / 55	55 / 56	58 / 58	59 / 62	62 / 63				
	Outdoor	Cooling/Heating	56 / 58	57 / 58	61 / 62	63 / 61	65 / 64				
Sound pressure level	Indoor	Cooling (Hi/Me/Lo/Ulo)	38 / 31 / 24 / 19	39 / 33 / 25 / 19	43 / 35 / 26 / 19	44 / 39 / 31 / 22	48 / 41 / 33 / 22				
		Heating (Hi/Me/Lo/Ulo)	38 / 33 / 25 / 19	40 / 34 / 27 / 19	42 / 35 / 28 / 19	47 / 41 / 33 / 23	47 / 42 / 34 / 23				
	Outdoor	Cooling/Heating	43 / 45	44 / 45	48 / 47	51 / 49	52 / 53				
Air flow	Indoor	Cooling (Hi/Me/Lo/Ulo)	11.3 / 9.1 / 6.0 / 5.0	12.2 / 10.0 / 6.7 / 5.0	13.1 / 10.8 / 7.3 / 5.0	14.3 / 12.4 / 7.8 / 5.4	16.3 / 13.4 / 8.9 / 5.4				
		Heating (Hi/Me/Lo/Ulo)	12.2 / 10.3 / 7.2 / 5.4	12.8 / 11.0 / 7.8 / 5.4	13.9 / 11.8 / 8.6 / 5.4	17.3 / 14.3 / 9.8 / 6.2	17.8 / 13.7 / 10.9 / 6.2				
	Outdoor	Cooling/Heating	31.0 / 31.0	31.0 / 31.0	36.0 / 31.0	39.0 / 33.0	41.5 / 39.0				
Exterior dimensions	Indoor	HeightxWidthxDepth	305 x 920 x 220								
	Outdoor		640 x 800(+71) x 290								
Net weight		Indoor / Outdoor	13.0 / 43.0			13.0 / 45.0					
Refrigerant		Type/GWP	R32 / 675								
		Charge	1.20 / 0.810				1.30 / 0.878				
Refrigerant piping size		Liquid/Gas	6.35(1/4") / 9.52(3/8")				6.35(1/4") / 12.7(1/2")				
Refrigerant line (one way) length [chargeless length]		m	Max.25 [15]				Max.30 [15]				
Vertical height differences		Outdoor is higher/lower	Max.15 / Max.15				Max.20 / Max.20				
Outdoor operating temperature range		Cooling					-15~46				
		Heating					-20~24				
Clean filter			Allergen Clear Filter x 1, Photocatalytic Washable Deodorising Filter x 1								

• The data are measured under the following conditions(ISO-T1, H1). Cooling: Indoor temp. of 27°CDB, 19°CWB, and outdoor temp. of 35°CDB. Heating: Indoor temp. of 20°CDB, and outdoor temp. of 7°CDB, 6°CWB.
 • Sound level indicates the value in an anechoic chamber. During operation these values are somewhat higher due to ambient conditions.
 • 'tonne(s) of CO₂ equivalent' means a quantity of greenhouse gases- expressed as the product of the weight of the greenhouse gases in metric tonnes and of their global warming potential.



SINGLE-SPLIT WALL MOUNTED TYPE



SRK-ZR-WF



SRK63ZR-WF, SRK71ZR-WF, SRK80ZR-WF, SRK100ZR-WF



BUILT IN WIRELESS LAN



Wireless remote control



SRC63ZR-W



SRC71ZR-W, SRC80ZR-W, FDC100VNP-W

KEY FEATURES

- ZR series is the ideal solution for heating and cooling larger spaces in your home
- Compact and light weighted
- Low Global Warming Potential (GWP) and High energy efficiency by new refrigerant R32
- Quiet Air Flow & Long Reach is achieved by jet technology
- Allergen clear operation cleans air, using a control scheme owned only by Mitsubishi Heavy Industries Thermal Systems
- Wireless interface control included

*SC-BIKN2-E cannot be used simultaneously with the Wireless LAN control system

SPECIFICATIONS

Indoor unit			SRK63ZR-WF	SRK71ZR-WF	SRK80ZR-WF	SRK100ZR-WF
Outdoor unit			SRC63ZR-W	SRC71ZR-W	SRC80ZR-W	FDC100VNP-W
Power source			1 Phase, 220 - 240V, 50Hz			
Nominal cooling capacity (Min~Max)		kW	6.3 (1.2~7.4)	7.1 (2.3~7.8)	8.0 (2.3~9.7)	9.6 (2.1~9.6)
Nominal heating capacity (Min~Max)		kW	7.1 (0.8~9.3)	8.0 (2.0~10.8)	9.0 (2.1~11.2)	10.0 (1.7~10.4)
Power consumption		Cooling/Heating	1.63 / 1.64	1.93 / 1.95	2.09 / 2.27	3.10 / 2.80
EER/COP		Cooling/Heating	3.87 / 4.33	3.68 / 4.10	3.83 / 3.96	3.10 / 3.57
Max. running current			14.5	17	17	19
Sound power level	Indoor	Cooling/Heating	56 / 58	57 / 60	60 / 62	63 / 63
	Outdoor	Cooling/Heating	64 / 65	63 / 63	67 / 67	68 / 67
Sound pressure level	Indoor	Cooling (Hi/Me/Lo/Ulo)	44 / 39 / 35 / 25	44 / 41 / 37 / 25	47 / 44 / 39 / 26	48 / 45 / 40 / 27
	Outdoor	Heating (Hi/Me/Lo/Ulo)	44 / 38 / 34 / 28	46 / 39 / 35 / 28	47 / 41 / 36 / 29	48 / 43 / 38 / 30
Air flow	Indoor	Cooling/Heating	54 / 54	53 / 51	56 / 55	56 / 54
	Outdoor	Cooling (Hi/Me/Lo/Ulo)	20.5 / 18.1 / 15.7 / 10.4	20.5 / 18.6 / 16.2 / 10.4	23.5 / 20.2 / 17.5 / 10.4	24.5 / 21.3 / 17.6 / 10.4
		Heating (Hi/Me/Lo/Ulo)	22.5 / 19.0 / 16.5 / 13.1	25.0 / 19.8 / 17.3 / 13.3	26.5 / 21.3 / 18.4 / 13.5	27.5 / 23.2 / 19.1 / 13.6
		Cooling/Heating	41.5 / 41.5	55 / 43.5	63 / 49.5	63 / 55
Exterior dimensions	Indoor	HeightxWidthxDepth	339 x 1197 x 262			
	Outdoor	HeightxWidthxDepth	640 x 800(+71) x 290	750 x 880(+88) x 340		
Net weight		Indoor / Outdoor	15.5 / 45.0	15.5 / 56.0	16.5 / 57.0	
Refrigerant		Type/GWP	R32 / 675			
		Charge	1.25 / 0.844	1.5 / 1.013	1.6 / 1.080	1.7 / 1.148
Refrigerant piping size		Liquid/Gas	6.35(1/4") / 12.7(1/2")		6.35(1/4") / 15.88(5/8")	
Refrigerant line (one way) length [chargeless length]		m	Max.30 [15]			
Vertical height differences		Outdoor is higher/lower	Max.20 / Max.20			
Outdoor operating temperature range		Cooling	-15~46			
		Heating	-15~24			
Clean filter			Allergen Clear Filter x 1, Photocatalytic Washable Deodorising Filter x 1			

* The data are measured under the following conditions(ISO-T1, H1). Cooling: Indoor temp. of 27°CDB, 19°CWB, and outdoor temp. of 35°CDB. Heating: Indoor temp. of 20°CDB, and outdoor temp. of 7°CDB, 6°CWB.

* Sound level indicates the value in an anechoic chamber. During operation these values are somewhat higher due to ambient conditions.

* 'tonne(s) of CO₂ equivalent' means a quantity of greenhouse gases- expressed as the product of the weight of the greenhouse gases in metric tonnes and of their global warming potential.



SINGLE-SPLIT WALL MOUNTED TYPE



SRK-ZR-W



SRK63ZR-W, SRK71ZR-W, SRK80ZR-W, SRK100ZR-W



OPTIONAL



Wireless remote control



SRC63ZR-W



SRC71ZR-W, SRC80ZR-W, FDC100VNP-W

KEY FEATURES

- ZR series is the ideal solution for heating and cooling larger spaces in your home
- Compact and light weighted . The 10.0kW outdoor unit is now 57kg and is 20% lighter than the previous model
- Low Global Warming Potential (GWP) and High energy efficiency by new refrigerant R32
- Quiet Air Flow & Long Reach is achieved by jet technology
- Allergen clear operation cleans air, using a control scheme owned only by Mitsubishi Heavy Industries Thermal Systems
- Wireless interface control (optional)

SPECIFICATIONS

Indoor unit			SRK63ZR-W	SRK71ZR-W	SRK80ZR-W	SRK100ZR-W
Outdoor unit			SRC63ZR-W	SRC71ZR-W	SRC80ZR-W	FDC100VNP-W
Power source			1 Phase, 220 - 240V, 50Hz			
Nominal cooling capacity (Min~Max)		kW	6.3 (1.2~7.4)	7.1 (2.3~7.8)	8.0 (2.3~9.7)	9.6 (2.1~9.6)
Nominal heating capacity (Min~Max)		kW	7.1 (0.8~9.3)	8.0 (2.0~10.8)	9.0 (2.1~11.2)	10.0 (1.7~10.4)
Power consumption		Cooling/Heating	1.63 / 1.64	1.93 / 1.95	2.09 / 2.27	3.10 / 2.80
EER/COP		Cooling/Heating	3.87 / 4.33	3.68 / 4.10	3.83 / 3.96	3.10 / 3.57
Max. running current		A	14.5	17	17	19
Sound power level	Indoor	Cooling/Heating	56 / 58	57 / 60	60 / 62	63 / 63
	Outdoor	Cooling/Heating	64 / 65	63 / 63	67 / 67	68 / 67
Sound pressure level	Indoor	Cooling (Hi/Me/Lo/Ulo)	44 / 39 / 35 / 25	44 / 41 / 37 / 25	47 / 44 / 39 / 26	48 / 45 / 40 / 27
	Outdoor	Heating (Hi/Me/Lo/Ulo)	44 / 38 / 34 / 28	46 / 39 / 35 / 28	47 / 41 / 36 / 29	48 / 43 / 38 / 30
Air flow	Indoor	Cooling/Heating	54 / 54	53 / 51	56 / 55	56 / 54
	Outdoor	Cooling (Hi/Me/Lo/Ulo)	20.5 / 18.1 / 15.7 / 10.4	20.5 / 18.6 / 16.2 / 10.4	23.5 / 20.2 / 17.5 / 10.4	24.5 / 21.3 / 17.6 / 10.4
		Heating (Hi/Me/Lo/Ulo)	22.5 / 19.0 / 16.5 / 13.1	25.0 / 19.8 / 17.3 / 13.3	26.5 / 21.3 / 18.4 / 13.5	27.5 / 23.2 / 19.1 / 13.6
		Cooling/Heating	41.5 / 41.5	55 / 43.5	63 / 49.5	63 / 55
Exterior dimensions	Indoor	HeightxWidthxDepth	339 x 1197 x 262			
	Outdoor	HeightxWidthxDepth	640 x 800(+71) x 290	750 x 880(+88) x 340		
Net weight		Indoor / Outdoor	15.5 / 45.0	15.5 / 56.0	16.5 / 57.0	
Refrigerant		Type/GWP	R32 / 675			
		Charge	1.25 / 0.844	1.5 / 1.013	1.6 / 1.080	1.7 / 1.148
Refrigerant piping size		Liquid/Gas	ø mm	6.35(1/4") / 12.7(1/2")		
Refrigerant line (one way) length [chargeless length]		m	Max.30 [15]			
Vertical height differences		Outdoor is higher/lower	Max.20 / Max.20			
Outdoor operating temperature range		Cooling	-15~46			
		Heating	-15~24			
Clean filter			Allergen Clear Filter x 1, Photocatalytic Washable Deodorising Filter x 1			

• The data are measured under the following conditions(ISO-T1, H1). Cooling: Indoor temp. of 27°CDB, 19°CWB, and outdoor temp. of 35°CDB. Heating: Indoor temp. of 20°CDB, and outdoor temp. of 7°CDB, 6°CWB.
 • Sound level indicates the value in an anechoic chamber. During operation these values are somewhat higher due to ambient conditions.
 • 'tonne(s) of CO₂ equivalent' means a quantity of greenhouse gases- expressed as the product of the weight of the greenhouse gases in metric tonnes and of their global warming potential.



SINGLE-SPLIT WALL MOUNTED TYPE

Premium Series

SRK-ZS-WF



Black & White(-WFB)



Titanium(-WFT)



SRK20ZS-WF, SRK25ZS-WF, SRK35ZS-WF, SRK50ZS-WF

Pure White(-WF)



BUILT IN WIRELESS LAN



Wireless remote control



SRC20ZS-W, SRC25ZS-W2, SRC35ZS-W2



SRC50ZS-W

KEY FEATURES

- Elegant, timeless design, best suited for small to medium sized living spaces
- Users can choose a colour they like from three different choices
- Low Global Warming Potential (GWP) and High energy efficiency by new refrigerant R32
- Quiet Air Flow & Long Reach is achieved by jet technology
- Colour variation available. Users can choose from three different choices
- Wireless interface control included

*SC-BIKN2-E cannot be used simultaneously with the Wireless LAN control system

SPECIFICATIONS

Indoor unit				SRK20ZS-WF,-WFB,-WFT	SRK25ZS-WF,-WFB,-WFT	SRK35ZS-WF,-WFB,-WFT	SRK50ZS-WF,-WFB,-WFT	
Outdoor unit				SRC20ZS-W	SRC25ZS-W2	SRC35ZS-W2	SRC50ZS-W	
Power source				1 Phase, 220 - 240V, 50Hz				
Nominal cooling capacity (Min~Max)		kW		2.0(0.9~2.9)	2.5(0.9~3.1)	3.5(0.9~4.0)	5.0(1.3~5.5)	
Nominal heating capacity (Min~Max)		kW		2.7(0.9~4.3)	3.2(0.9~4.5)	4.0(0.9~5.0)	5.8(1.3~6.6)	
Power consumption		Cooling/Heating	kW	0.44 / 0.59	0.62 / 0.74	0.89 / 0.94	1.35 / 1.56	
EER/COP		Cooling/Heating		4.55 / 4.58	4.03 / 4.32	3.93 / 4.26	3.70 / 3.72	
Max. running current			A	9	9	9	14.5	
Sound power level	Indoor	Cooling/Heating	dB(A)	48 / 50	50 / 53	54 / 56	59 / 60	
	Outdoor	Cooling/Heating		56 / 56	56 / 58	61 / 61	61 / 63	
Sound pressure level	Indoor	Cooling (Hi/Me/Lo/Ulo)		34 / 25 / 22 / 19	36 / 28 / 23 / 19	40 / 30 / 26 / 19	46 / 36 / 29 / 22	
	Outdoor	Heating (Hi/Me/Lo/Ulo)		36 / 29 / 23 / 19	39 / 30 / 24 / 19	41 / 36 / 25 / 19	46 / 37 / 31 / 24	
Air flow	Indoor	Cooling/Heating	m ³ /min	45 / 45	46 / 46	50 / 48	51 / 52	
	Outdoor	Cooling (Hi/Me/Lo/Ulo)		9.3 / 7.0 / 5.9 / 5.0	9.9 / 8.0 / 5.9 / 5.0	11.3 / 8.7 / 7.0 / 5.0	12.1 / 9.9 / 7.4 / 5.9	
Exterior dimensions	Indoor	HeightxWidthxDepth		mm	290 x 870 x 230			
	Outdoor	HeightxWidthxDepth			540 x 780(+62) x 290		595 x 780(+62) x 290	
Net weight		Indoor / Outdoor	kg	9.5 / 31.0		9.5 / 34.5		
Refrigerant		Type/GWP		R32 / 675				
		Charge	kg/TCO ₂ Eq	0.62 / 0.419		0.78 / 0.527		
Refrigerant piping size		Liquid/Gas	ø mm	6.35(1/4") / 9.52(3/8")				
Refrigerant line (one way) length [chargeless length]			m	Max. 20 [15]				
Vertical height differences		Outdoor is higher/lower	m	Max. 10 / Max. 10				
Outdoor operating temperature range		Cooling	°CDB	-15~46				
		Heating		-15~24				
Clean filter				Allergen Clear Filter x 1, Photocatalytic Washable Deodorising Filter x 1				

* The data are measured under the following conditions(ISO-T1, H1). Cooling: Indoor temp. of 27°CDB, 19°CWB, and outdoor temp. of 35°CDB. Heating: Indoor temp. of 20°CDB, and outdoor temp. of 7°CDB, 6°CWB.

* Sound level indicates the value in an anechoic chamber. During operation these values are somewhat higher due to ambient conditions.

* 'tonne(s) of CO₂ equivalent' means a quantity of greenhouse gases- expressed as the product of the weight of the greenhouse gases in metric tonnes and of their global warming potential.



SINGLE-SPLIT WALL MOUNTED TYPE

Premium Series

SRK-ZS-W



SRK20ZS-W, SRK25ZS-W,
SRK35ZS-W, SRK50ZS-W



OPTIONAL



Wireless remote control



SRC20ZS-W, SRC25ZS-W2
SRC35ZS-W2



SRC50ZS-W

KEY FEATURES

- Elegant, timeless design, best suited for small to medium sized living spaces
- Low Global Warming Potential (GWP) and High energy efficiency by new refrigerant R32
- Quiet Air Flow & Long Reach is achieved by jet technology
- Allergen clear operation cleans air, using a control scheme owned only by Mitsubishi Heavy Industries Thermal Systems
- Wireless interface control (optional)

SPECIFICATIONS

Indoor unit				SRK20ZS-W	SRK25ZS-W	SRK35ZS-W	SRK50ZS-W	
Outdoor unit				SRC20ZS-W	SRC25ZS-W2	SRC35ZS-W2	SRC50ZS-W	
Power source				1 Phase, 220 - 240V, 50Hz				
Nominal cooling capacity (Min~Max)		kW		2.0(0.9~2.9)	2.5(0.9~3.1)	3.5(0.9~4.0)	5.0(1.3~5.5)	
Nominal heating capacity (Min~Max)		kW		2.7(0.9~4.3)	3.2(0.9~4.5)	4.0(0.9~5.0)	5.8(1.3~6.6)	
Power consumption		Cooling/Heating	kW	0.44 / 0.59	0.62 / 0.74	0.89 / 0.94	1.35 / 1.56	
EER/COP		Cooling/Heating		4.55 / 4.58	4.03 / 4.32	3.93 / 4.26	3.70 / 3.72	
Max. running current			A	9	9	9	14.5	
Sound power level	Indoor	Cooling/Heating	dB(A)	48 / 50	50 / 53	54 / 56	59 / 60	
	Outdoor	Cooling/Heating		56 / 56	56 / 58	61 / 61	61 / 63	
Sound pressure level	Indoor	Cooling (Hi/Me/Lo/Ulo)		34 / 25 / 22 / 19	36 / 28 / 23 / 19	40 / 30 / 26 / 19	46 / 36 / 29 / 22	
	Outdoor	Heating (Hi/Me/Lo/Ulo)		36 / 29 / 23 / 19	39 / 30 / 24 / 19	41 / 36 / 25 / 19	46 / 37 / 31 / 24	
Air flow	Indoor	Cooling/Heating	m ³ /min	45 / 45	46 / 46	50 / 48	51 / 52	
	Outdoor	Cooling/Heating		9.3 / 7.0 / 5.9 / 5.0	9.9 / 8.0 / 5.9 / 5.0	11.3 / 8.7 / 7.0 / 5.0	12.1 / 9.9 / 7.4 / 5.9	
Exterior dimensions	Indoor	HeightxWidthxDPTH		mm	290 x 870 x 230			
	Outdoor	HeightxWidthxDPTH			540 x 780(+62) x 290		595 x 780(+62) x 290	
Net weight		Indoor / Outdoor	kg	9.5 / 31.0		9.5 / 34.5		
Refrigerant		Type/GWP		R32 / 675				
		Charge	kg/TCO ₂ Eq	0.62 / 0.419		0.78 / 0.527		
Refrigerant piping size		Liquid/Gas	ø mm	6.35(1/4") / 9.52(3/8")			6.35(1/4") / 12.7(1/2")	
Refrigerant line (one way) length [chargeless length]			m	Max. 20 [15]			Max. 25 [15]	
Vertical height differences		Outdoor is higher/lower	m	Max. 10 / Max. 10			Max. 15 / Max. 15	
Outdoor operating temperature range		Cooling	°CDB	-15~46				
		Heating		-15~24				
Clean filter				Allergen Clear Filter x 1, Photocatalytic Washable Deodorising Filter x 1				

* The data are measured under the following conditions(ISO-T1, H1). Cooling: Indoor temp. of 27°CDB, 19°CWB, and outdoor temp. of 35°CDB. Heating: Indoor temp. of 20°CDB, and outdoor temp. of 7°CDB, 6°CWB.

* Sound level indicates the value in an anechoic chamber. During operation these values are somewhat higher due to ambient conditions.

* 'tonne(s) of CO₂ equivalent' means a quantity of greenhouse gases- expressed as the product of the weight of the greenhouse gases in metric tonnes and of their global warming potential.



SINGLE-SPLIT WALL MOUNTED TYPE



SRK-ZTL-W



SRK15ZTL-W, SRK20ZTL-W, SRK25ZTL-W, SRK35ZTL-W, SRK50ZTL-W



BUILT IN WIRELESS LAN



SRK63ZTL-W, SRK71ZTL-W



Wireless remote control



SRC15ZTL-W, SRC20ZTL-W, SRC25ZTL-W, SRC35ZTL-W



SRC50ZTL-W



SRC63ZTL-W, SRC71ZTL-W

SPECIFICATIONS

Indoor unit			SRK15ZTL-W	SRK20ZTL-W	SRK25ZTL-W	SRK35ZTL-W
Outdoor unit			SRC15ZTL-W	SRC20ZTL-W	SRC25ZTL-W	SRC35ZTL-W
Power source			1 Phase, 220 - 240V, 50Hz			
Nominal cooling capacity (Min~Max)		kW	1.5 (0.7 ~ 2.5)	2.0 (0.7 ~ 2.8)	2.5 (0.8 ~ 3.2)	3.5 (0.8 ~ 3.7)
Nominal heating capacity (Min~Max)		kW	2.0 (0.9 ~ 4.1)	2.7 (0.9 ~ 4.2)	3.0 (1.0 ~ 4.8)	3.8 (1.0 ~ 4.9)
Power consumption		Cooling/Heating kW	0.35 / 0.42	0.51 / 0.64	0.58 / 0.66	1.05 / 0.90
EER/COP		Cooling/Heating	4.29 / 4.76	3.92 / 4.22	4.31 / 4.55	3.33 / 4.22
Max. running current		A	9.0	9.0	9.0	9.0
Sound power level	Indoor	Cooling/Heating	51 / 53	52 / 54	55 / 55	56 / 57
	Outdoor	Cooling/Heating	56 / 57	57 / 57	58 / 59	61 / 62
Sound pressure level	Indoor	Cooling (Hi/Me/Lo/Ulo)	36 / 30 / 23 / 19	37 / 31 / 23 / 19	41 / 36 / 26 / 22	42 / 37 / 27 / 22
		Heating (Hi/Me/Lo/Ulo)	38 / 32 / 24 / 19	39 / 34 / 25 / 19	41 / 36 / 29 / 22	43 / 37 / 31 / 22
	Outdoor	Cooling/Heating	43 / 44	45 / 46	47 / 46	50 / 50
Air flow	Indoor	Cooling (Hi/Me/Lo/Ulo)	9.5 / 7.5 / 4.9 / 3.8	9.9 / 7.8 / 4.9 / 3.8	10.0 / 8.0 / 5.3 / 4.4	10.4 / 8.5 / 5.4 / 4.4
		Heating (Hi/Me/Lo/Ulo)	10.0 / 8.7 / 5.8 / 4.4	10.4 / 9.1 / 6.2 / 4.4	11.0 / 9.4 / 6.5 / 5.0	11.8 / 9.8 / 6.8 / 5.0
	Outdoor	Cooling/Heating	21.9 / 20.8	23.7 / 20.8	22.8 / 20.9	25.4 / 21.7
Exterior dimensions	Indoor	HeightxWidthxDepth	294 x 798 x 210			
	Outdoor	HeightxWidthxDepth	540 x 645 (+57) x 275			
Net weight	Indoor / Outdoor		8.5 / 22.0		9.0 / 24.0	
	Refrigerant		Type/GWP	R32 / 675		
		Charge	kg/TCO ₂ Eq		0.43 / 0.29	
Refrigerant piping size		Liquid/Gas	ø mm			
Refrigerant line (one way) length [chargeless length]		m	Max.20 [10]			
Vertical height differences		Outdoor is higher/lower	m			
Outdoor operating temperature range	Cooling		Max.15 / Max.15			
	Heating		-15~46			
Clean filter			-15~24			
Allergen Clear Filter x 1, Photocatalytic Washable Deodorising Filter x 1(option)						

* The data are measured under the following conditions(ISO-T1, H1). Cooling: Indoor temp. of 27°CDB, 19°CWB, and outdoor temp. of 35°CDB. Heating: Indoor temp. of 20°CDB, and outdoor temp. of 7°CDB, 6°CWB.

* Sound level indicates the value in an anechoic chamber. During operation these values are somewhat higher due to ambient conditions.

* 'tonne(s) of CO₂ equivalent' means a quantity of greenhouse gases- expressed as the product of the weight of the greenhouse gases in metric tonnes and of their global warming potential.



Elegant timeless design

- Simple yet an elegant, designed by an Italian designing company
- When the unit is mounted the intake will be partially hidden
- Small in size (compared to ZR•ZS series)



Remote control

- Simple design and easy to use
- Temperature controlled in 0.5°C units
- Easy to see with backlight



KEY FEATURES

- Elegant timeless design with compact sizing
- Small capacity down to 1.5 kW to perfectly fit any small or well insulated rooms
- Wireless Control System is included
*SC-BIKN2-E cannot be used simultaneously with the Wireless LAN control system
- Remote control with simple design
- 2 levels of silent modes are available to further reduce the outdoor unit noise level
- The longest pipe length and highest differential height
- Lightweight outdoor unit offers great installation flexibility

SRK50ZTL-W SRC50ZTL-W	SRK63ZTL-W SRC63ZTL-W	SRK71ZTL-W SRC71ZTL-W
1 Phase, 220 - 240V, 50Hz		
5.0 (1.3 ~ 5.3)	6.3 (1.2 ~ 7.1)	7.1 (1.2~7.3)
5.8 (1.3 ~ 6.3)	7.1 (1.0 ~ 8.5)	8.0 (1.1~9.1)
1.59 / 1.62	1.84 / 2.01	2.45 / 2.37
3.14 / 3.58	3.42 / 3.53	2.90 / 3.38
14.5	17.0	17.0
60 / 60	60 / 61	61 / 62
64 / 65	64 / 66	66 / 66
47 / 40 / 32 / 25	46 / 43 / 38 / 30	48 / 44 / 39 / 31
47 / 40 / 33 / 25	47 / 43 / 39 / 32	47 / 44 / 40 / 33
52 / 53	52 / 54	53 / 54
12.5 / 10.4 / 7.2 / 5.4	17.0 / 14.7 / 12.1 / 9.4	17.5 / 15.2 / 12.6 / 9.4
12.6 / 11.5 / 8.9 / 6.4	18.4 / 17.2 / 14.1 / 11.6	18.9 / 17.7 / 14.6 / 11.6
35.6 / 33.8	43.0 / 40.9	43.0 / 40.9
294 x 798 x 210		294 x 998 x 230
595 x 780(+62) x 290		640 x 800 (+71) x 290
9.5 / 33.0		12.0 / 42.5
	R32 / 675	
0.9 / 0.61		1.20 / 0.81
6.35 (1/4") / 12.7 (1/2")		6.35 (1/4") / 12.7 (1/2")
Max.25 [15]		Max.30 [15]
Max.20 / Max.20		Max.20 / Max.20
	-15~46	
	-15~24	
Allergen Clear Filter x 1, Photocatalytic Washable Deodorising Filter x 1(option)		



SINGLE-SPLIT WALL MOUNTED TYPE



SRK-ZSP-W1

New!



SRK25ZSP-W1, SRK35ZSP-W1, SRK45ZSP-W1, SRK50ZSP-W1



Wireless remote control



SRC25ZSP-W1, SRC35ZSP-W1



SRC45ZSP-W1, SRC50ZSP-W1

KEY FEATURES

- The compact design of the ZSP series makes it perfect for small spaces such as spare bedrooms and home offices
- Energy class improvement. All class A⁺⁺
- Low Global Warming Potential (GWP) and High energy efficiency by new refrigerant R32
- The compact and lightweight design of outdoor unit offers great installation flexibility
- Self-cleaning operation helps keep the room air clean

SPECIFICATIONS

Indoor unit			SRK25ZSP-W1	SRK35ZSP-W1	SRK45ZSP-W1	SRK50ZSP-W1
Outdoor unit			SRC25ZSP-W1	SRC35ZSP-W1	SRC45ZSP-W1	SRC50ZSP-W1
Power source			1 Phase, 220 - 240V, 50Hz			
Nominal cooling capacity (Min~Max)		kW	2.5(0.8~3.2)	3.2(0.9~3.7)	4.5(1.3~4.8)	5.0(1.3~5.2)
Nominal heating capacity (Min~Max)		kW	2.8(0.8~4.1)	3.6(0.9~4.6)	5.0(1.2~5.8)	5.6(1.2~5.8)
Power consumption		Cooling/Heating	0.710 / 0.690	0.910 / 0.930	1.390 / 1.360	1.740 / 1.660
EER/COP		Cooling/Heating	3.52/4.05	3.52 / 3.87	3.23 / 3.68	2.87 / 3.37
Max. running current		A	9	9	14.5	14.5
Sound power level	Indoor	Cooling/Heating	57 / 56	57 / 57	57 / 62	59 / 62
	Outdoor	Cooling/Heating	57 / 57	59 / 60	64 / 62	65 / 65
Sound pressure level	Indoor	Cooling (Hi/Me/Lo)	44 / 33 / 21	44 / 35 / 22	44 / 37 / 22	46 / 37 / 22
		Heating (Hi/Me/Lo)	42 / 33 / 25	44 / 35 / 27	48 / 40 / 28	48 / 40 / 28
	Outdoor	Cooling/Heating	47 / 45	47 / 47	51 / 51	52 / 52
		Air flow	Indoor	Cooling (Hi/Me/Lo)	10.0 / 7.6 / 4.3	10.4 / 7.2 / 4.3
	Outdoor	Heating (Hi/Me/Lo)	9.6 / 7.6 / 5.3	9.9 / 7.2 / 5.5	12.0 / 8.8 / 5.4	12.0 / 8.8 / 5.4
		Cooling/Heating	21.9 / 21.9	22.8 / 22.0	35.6 / 33.4	37.7 / 35.6
Exterior dimensions	Indoor	HeightxWidthxDensity	267 x 783 x 210			
	Outdoor		540 x 645(+57) x 275		595 x 780(+62) x 290	
Net weight		Indoor / Outdoor	7.0 / 22.0	7.0 / 24.0	7.5 / 33.0	
Refrigerant		Type/GWP	R32 / 675			
		Charge	kg/TCO ₂ Eq	0.480 / 0.324	0.650 / 0.439	0.950 / 0.641
Refrigerant piping size		Liquid/Gas	ø mm	6.35(1/4") / 9.52(3/8")		6.35(1/4") / 12.7(1/2")
Refrigerant line (one way) length [chargeless length]		m	Max. 15 [10]	Max. 15 [Not required]	Max. 25 [15]	
Vertical height differences		Outdoor is higher/lower	m			
			Max. 15 / Max. 15			
Outdoor operating temperature range		Cooling	°CDB			
		Heating	-15~46			
Clean filter			-15~24			
			-			

* The data are measured under the following conditions(ISO-T1, H1). Cooling: Indoor temp. of 27°CDB, 19°CWB, and outdoor temp. of 35°CDB. Heating: Indoor temp. of 20°CDB, and outdoor temp. of 7°CDB, 6°CWB.

* Sound level indicates the value in an anechoic chamber. During operation these values are somewhat higher due to ambient conditions.

* 'tonne(s) of CO₂ equivalent' means a quantity of greenhouse gases- expressed as the product of the weight of the greenhouse gases in metric tonnes and of their global warming potential.



SINGLE-SPLIT FLOOR STANDING TYPE

SRF-ZS/ZSX

Auto air outlet selection

In case both lower and upper air outlets can be selected.



Installation workability

Piping and drain hose connection can be selected out of 6-directions.

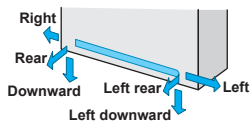

SRF25ZS-W, SRF35ZS-W,
SRF50ZSX-W

Wireless
remote control



SRC25ZS-W2, SRC35ZS-W2



SRC50ZSX-W2,-W3

KEY FEATURES

- The elegant semi flat front panel in stylish white, fit various kinds of rooms and create relaxing atmosphere
- Choice from wall hanging, floor standing or behind gallery installation is available
- Low Global Warming Potential (GWP) and High energy efficiency by new refrigerant R32
- Quiet Operation. The level of 25ZS-W in the cooling Ulo mode is only 25dB(A)
- The "flap control system" allows users to change flap angles and positions according to their preference. Flaps can be set at different angles
- Allergen clear filter is equipped as a default

SPECIFICATIONS

Indoor unit			SRF25ZS-W	SRF35ZS-W	SRF50ZSX-W	
Outdoor unit			SRC25ZS-W2	SRC35ZS-W2	SRC50ZSX-W2,-W3	
Power source			1 Phase, 220 - 240V, 50Hz			
Nominal cooling capacity (Min~Max)		kW	2.5 (0.9~3.1)	3.5 (0.9~4.1)	5.0 (1.1~5.6)	
Nominal heating capacity (Min~Max)		kW	2.9 (0.8~3.7)	4.5 (0.8~5.2)	6.0 (0.8~7.4)	
Power consumption		kW	0.59 / 0.66	0.82 / 1.12	1.32 / 1.58	
EER/COP		Cooling/Heating	4.24 / 4.39	4.27 / 4.02	3.79 / 3.80	
Max. running current		A	9	9	15	
Sound power level	Indoor	Cooling/Heating	50 / 51	51 / 52	58 / 58	
	Outdoor	Cooling/Heating	59 / 60	63 / 64	63 / 62	
Sound pressure level	Indoor	Cooling (Hi/Me/Lo/Ulo)	38 / 32 / 29 / 25	40 / 35 / 33 / 29	46 / 38 / 33 / 28	
		Heating (Hi/Me/Lo/Ulo)	39 / 35 / 33 / 29	41 / 36 / 35 / 33	46 / 41 / 38 / 32	
	Outdoor	Cooling/Heating	45 / 47	50 / 51	51 / 51	
		Cooling (Hi/Me/Lo/Ulo)	9.0 / 7.6 / 6.7 / 5.8	9.2 / 7.8 / 7.3 / 6.4	11.5 / 9.6 / 7.4 / 6.6	
Air flow	Indoor	Heating (Hi/Me/Lo/Ulo)	10.5 / 8.2 / 7.7 / 6.6	10.7 / 8.3 / 8.1 / 7.4	12.0 / 10.0 / 9.4 / 7.6	
	Outdoor	Cooling/Heating	27.4 / 27.4	31.5 / 31.5	39.0 / 33.0	
Exterior dimensions	Indoor	HeightxWidthxDepth	600 x 860 x 238			
	Outdoor		540 x 780(+62) x 290		640 x 800(+71) x 290	
Net weight		Indoor / Outdoor	kg	18.0 / 31.0	19.0 / 34.5	19.0 / 45.0
Refrigerant		Type/GWP		R32 / 675		
		Charge	kg/TCO ₂ Eq	0.62/0.419	0.78/0.527	1.30 / 0.878
Refrigerant piping size		Liquid/Gas	ø mm	6.35(1/4") / 9.52(3/8")		
Refrigerant line (one way) length[chargeless length]			m	Max. 20 [10]	Max. 20 [15]	Max. 30 [15]
Vertical height differences		Outdoor is higher/lower	m	Max. 10 / Max. 10		
Outdoor operating temperature range		Cooling	°CDB	-15~46		
		Heating		-15~24		
Clean filter				Allergen Clear Filter x 1 Photocatalytic Washable Deodorising Filter x 1		

* The data are measured under the following conditions(ISO-T1, H1). Cooling: Indoor temp. of 27°CDB, 19°CWB, and outdoor temp. of 35°CDB. Heating: Indoor temp. of 20°CDB, and outdoor temp. of 7°CDB, 6°CWB.

* Sound level indicates the value in an anechoic chamber. During operation these values are somewhat higher due to ambient conditions.

* 'tonne(s) of CO₂ equivalent' means a quantity of greenhouse gases- expressed as the product of the weight of the greenhouse gases in metric tonnes and of their global warming potential.



SINGLE-SPLIT CEILING CONCEALED TYPE

SRR-ZS

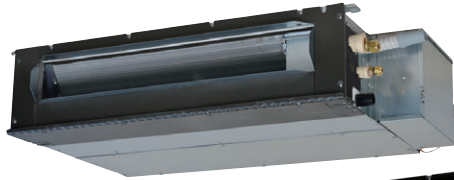

SRR25ZS-W, SRR35ZS-W

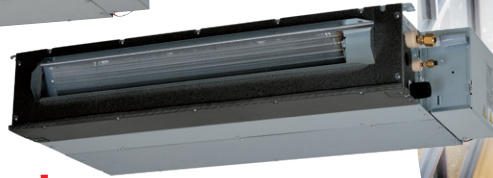

New! SRR50ZS-W, SRR60ZS-W



Enhanced Installation Workability

600mm Drain Pump is mounted in all models. The indoor unit is completely hidden in the ceiling, so this is suitable for spaces with classy interior decoration.

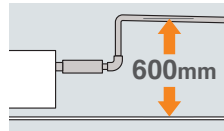

Bottom air inlet kit (optional)

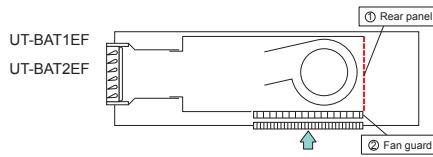

Wired remote control (optional)



KEY FEATURES

- The SRR series' indoor unit is concealed under the ceiling and is perfect a for a living room or bedroom area
- Compact design, with a height of only 200mm
- Low Global Warming Potential (GWP) and High energy efficiency by new refrigerant R32
- Quiet Operation
- Low Static Pressure Level

SPECIFICATIONS

Indoor unit			SRR25ZS-W	SRR35ZS-W	SRR50ZS-W	SRR60ZS-W
Outdoor unit			SRC25ZS-W2	SRC35ZS-W2	SRC50ZSX-W3	SRC60ZSX-W3
Power source			1 Phase, 220 - 240V, 50Hz			
Nominal cooling capacity (Min~Max)		kW	2.5 (0.9 ~ 3.2)	3.5 (0.9 ~ 4.1)	5.0 (1.2 ~ 6.0)	5.6 (1.2 ~ 6.5)
Nominal heating capacity (Min~Max)		kW	2.9 (0.9 ~ 4.4)	4.2 (1.0 ~ 5.2)	5.4 (1.0 ~ 8.2)	6.7 (1.0 ~ 8.6)
Power consumption	Cooling/Heating	kW	0.62 / 0.65	0.93 / 1.01	1.42 / 1.39	1.70 / 1.89
EER/COP	Cooling/Heating		4.03 / 4.46	3.76 / 4.16	3.52 / 3.88	3.29 / 3.54
Max. running current		A	9	9	15	15
Sound power level	Indoor	Cooling/Heating	56 / 59	57 / 60	59 / 61	60 / 63
	Outdoor	Cooling/Heating	58 / 58	62 / 62	63 / 62	65 / 65
Sound pressure level	Indoor	Cooling (Hi/Me/Lo/Ulo)	37 / 33 / 30 / 24	38 / 34 / 31 / 25	41 / 37 / 34 / 29	44 / 38 / 35 / 30
	Outdoor	Heating (Hi/Me/Lo/Ulo)	40 / 37 / 34 / 28	42 / 38 / 35 / 29	43 / 39 / 37 / 32	45 / 41 / 38 / 33
Air flow	Indoor	Cooling/Heating	47 / 47	50 / 50	51 / 49	52 / 53
	Outdoor	Cooling (Hi/Me/Lo/Ulo)	9.5 / 8.0 / 6.5 / 4.5	10.0 / 8.5 / 7.0 / 5.0	13.5 / 11.0 / 10.0 / 7.5	14.5 / 11.5 / 10.5 / 8.0
		Heating (Hi/Me/Lo/Ulo)	10.0 / 9.0 / 8.0 / 6.0	10.5 / 9.5 / 8.5 / 6.5	14.0 / 12.5 / 11.0 / 8.5	15.0 / 13.0 / 11.5 / 9.0
		Cooling/Heating	27.4 / 23.6	31.5 / 27.8	39.0 / 33.0	41.5 / 39.0
External static pressure		Pa	Standard : 5 ¹ (Initial static pressure with air filter : 5Pa)			
Exterior dimensions	Indoor	HeightxWidthxDepth	200 x 750 x 500		200 x 950 x 500	
	Outdoor		540 x 780(+62) x 290		640 x 800(+71) x 290	
Net weight		Indoor / Outdoor	kg	20.5 / 31.0	20.5 / 34.5	24.0 / 45.0
Refrigerant		Type/GWP	R32 / 675			
		Charge	kg/TCO ₂ Eq	0.62 / 0.419	0.78 / 0.527	1.30 / 0.878
Refrigerant piping size		Liquid/Gas	ø mm	6.35(1/4") / 9.52(3/8")		6.35(1/4") / 12.7(1/2")
Refrigerant line (one way) length[chargeless length]			m	Max. 20 [15]		Max. 30 [15]
Vertical height differences		Outdoor is higher/lower	m	Max. 10 / Max.10		Max. 20 / Max.20
Outdoor operating temperature range		Cooling	°CDB	-15~46		-15~46
		Heating		-15~24		-20~24
Bottom air inlet kit (option)				UT-BAT1EF		UT-BAT2EF

* The data are measured under the following conditions(ISO-T1, H1). Cooling: Indoor temp. of 27°CDB, 19°CWB, and outdoor temp. of 35°CDB. Heating: Indoor temp. of 20°CDB, and outdoor temp. of 7°CDB, 6°CWB.

* Sound level indicates the value in an anechoic chamber. During operation these values are somewhat higher due to ambient conditions.

* 'tonne(s) of CO₂ equivalent' means a quantity of greenhouse gases- expressed as the product of the weight of the greenhouse gases in metric tonnes and of their global warming potential.

*1 The maximum external static pressure can be used up to 35Pa(25*35ZS), 50Pa(50*60ZS), but the airflow will be reduced.



SINGLE-SPLIT 4WAY CEILING CASSETTE TYPE

FDTC-VH



European Design & Flat Panel

European grill design invented by Zweigrad GmbH & Co. KG in Germany, that blends well with the room.



Honeycomb type



Grid type

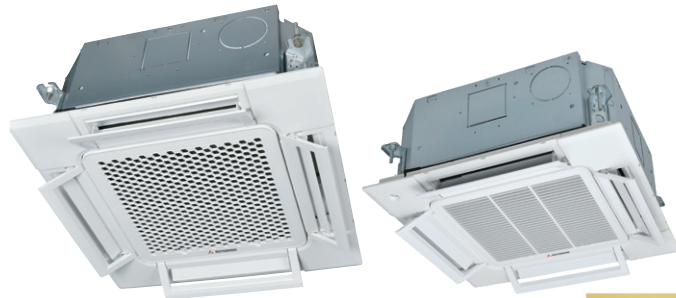

FDTC25VH1, FDTC35VH1, FDTC40VH, FDTC50VH, FDTC60VH



Wired remote control (optional) Wireless remote control (optional) Motion sensor (optional)



RC-EX3A



RC-E5



RCH-E3



RCN-TC-5AW -E3



LB-TC-5W-E

KEY FEATURES

- Height of the thin panel and the main body is only 248mm allowing a very easy installation. Integrated ceiling system design (600×600)
- Low Global Warming Potential (GWP) and high energy efficiency by new refrigerant R32
- Draft Prevention Panel (optional) prevents cold/hot draft from being blown directly on the user. Draft Prevention Panel could be installed for each air outlet
- Motion sensor (optional) is an energy saving operation function that detects human movement and saves energy
- Noise has been reduced by adopting a new turbo fan and improving the heat exchanger



SRC25ZS-W2, SRC35ZS-W2



SRC40ZSX-W1, SRC50ZSX-W2,-W3, SRC60ZSX-W1, -W3

SPECIFICATIONS

			FDTC25VH1	FDTC35VH1	FDTC40VH	FDTC50VH	FDTC60VH	
Indoor unit								
Outdoor unit			SRC25ZS-W2	SRC35ZS-W2	SRC40ZSX-W1	SRC50ZSX-W2,-W3	SRC60ZSX-W1,-W3	
Power source			1 Phase, 220 - 240V, 50Hz					
Nominal cooling capacity (Min~Max)		kW	2.5 (0.9~ 3.2)	3.5 (0.9 ~ 4.3)	4.0 (1.1 ~ 4.7)	5.0 (1.1 ~ 5.6)	5.6 (1.1 ~ 6.3)	
Nominal heating capacity (Min~Max)		kW	2.9 (0.9 ~ 4.0)	4.25 (0.9 ~ 4.6)	4.5 (0.6 ~ 5.4)	5.4 (0.6 ~ 6.3)	6.7 (0.6 ~ 6.7)	
Power consumption		Cooling/Heating	0.61 / 0.71	0.91 / 1.15	0.98 / 1.13	1.40 / 1.53	1.73 / 2.14	
EER/COP		Cooling/Heating	4.10 / 4.08	3.85 / 3.70	4.08 / 3.98	3.58 / 3.53	3.23 / 3.13	
Max. running current		A	9	9	15	15	15	
Sound power level	Indoor	Cooling/Heating	51 / 52	52 / 53	59 / 59	59 / 59	60 / 60	
	Outdoor	Cooling/Heating	58 / 59	62 / 62	63 / 62	63 / 62	65 / 65	
Sound pressure level	Indoor	Cooling (P-Hi/Hi/Me/Lo)	38 / 34 / 30 / 27	39 / 36 / 32 / 29	44 / 40 / 35 / 27	44 / 40 / 35 / 27	46 / 42 / 38 / 31	
		Heating (P-Hi/Hi/Me/Lo)	39 / 36 / 32 / 28	41 / 38 / 34 / 30	44 / 40 / 35 / 27	44 / 40 / 35 / 27	46 / 42 / 38 / 31	
	Outdoor	Cooling/Heating	47 / 47	50 / 50	52 / 50	52 / 50	53 / 54	
		Air flow	Indoor	Cooling (P-Hi/Hi/Me/Lo)	8.5 / 7.5 / 7.0 / 6.0	9.0 / 8.0 / 7.5 / 6.5	13 / 11 / 9 / 7	13 / 11 / 9 / 7
		Outdoor	Heating (P-Hi/Hi/Me/Lo)	9.5 / 8.5 / 7.5 / 6.5	10.0 / 9.0 / 8.0 / 7.0	13 / 11 / 9 / 7	13 / 11 / 9 / 8	14 / 12 / 10 / 8
		Outdoor	Cooling/Heating	27.4 / 27.4	31.5 / 31.5	33 / 33	39 / 33	41.5 / 39
Exterior dimensions	Indoor	HeightxWidthxDepth	mm	Unit : 248 x 570 x 570 Panel : 10 x 620 x 620				
	Outdoor			540 x 780(+62) x 290	640 x 800(+71) x 290			
Net weight	Indoor		kg	16.0 (Unit : 13.5 Panel : 2.5)		16.5 (Unit : 14 Panel : 2.5)		
	Outdoor			31.0	34.5	45.0		
Refrigerant	Type/GWP	R32 / 675						
	Charge	kg/TCO ₂ Eq	0.62 / 0.419	0.78 / 0.527	1.30 / 0.878			
Refrigerant piping size	Liquid/Gas	ø mm	6.35(1/4") / 9.52(3/8")		6.35(1/4") / 12.7(1/2")			
Refrigerant line (one way) length [chargeless length]		m	Max. 20 [15]		Max. 30 [15]			
Vertical height differences	Outdoor is higher/lower	m	Max. 10 / Max.10		Max. 20 / Max.20			
Outdoor operating temperature range	Cooling	°CDB	-15~46					
	Heating		-15~24		-20~24			
Panel		Standard Panel : TC-PSA-5AW-E(Honeycomb), TC-PSAG-5AW-E(Grid) Draft Prevention Panel : TC-PSAE-5AW-E(Honeycomb), TC-PSAGE-5AW-E(Grid)						

* The data are measured under the following conditions(ISO-T1, H1). Cooling: Indoor temp. of 27°CDB, 19°CWB, and outdoor temp. of 35°CDB. Heating: Indoor temp. of 20°CDB, and outdoor temp. of 7°CDB, 6°CWB.

• Sound level indicates the value in an anechoic chamber. During operation these values are somewhat higher due to ambient conditions.

• 'tonne(s) of CO₂ equivalent' means a quantity of greenhouse gases- expressed as the product of the weight of the greenhouse gases in metric tonnes and of their global warming potential.



SINGLE-SPLIT WALL MOUNTED TYPE



SRK-ZSX-S



SRK20ZSX-S, SRK25ZSX-S, SRK35ZSX-S
SRK50ZSX-S, SRK60ZSX-S



OPTIONAL



Wireless remote control



SRC20ZSX-S, SRC25ZSX-S, SRC35ZSX-S,
SRC50ZSX-S, SRC60ZSX-S

KEY FEATURES

- Elegant Timeless Design
- High seasonal efficiency performance is up to A+++ in cooling and heating
- Quiet Air Flow & Long Reach is achieved by jet technology
- Allergen clear operation cleans air, using a control scheme owned only by Mitsubishi Heavy Industries Thermal Systems
- Wireless interface control (optional)

SPECIFICATIONS

Indoor unit			SRK20ZSX-S	SRK25ZSX-S	SRK35ZSX-S	SRK50ZSX-S	SRK60ZSX-S		
Outdoor unit			SRC20ZSX-S	SRC25ZSX-S	SRC35ZSX-S	SRC50ZSX-S	SRC60ZSX-S		
Power source			1Phase, 220 - 240V, 50Hz						
Nominal cooling capacity (Min~Max)		kW	2.0 (0.9~3.2)	2.5 (0.9~3.7)	3.5 (0.9~4.3)	5.0 (1.0~5.8)	6.1 (1.0~6.8)		
Nominal heating capacity (Min~Max)		kW	2.7 (0.8~5.3)	3.2 (0.8~5.8)	4.3 (0.8~6.6)	6.0 (0.6~8.1)	6.8 (0.6~8.7)		
Power consumption		kW	Cooling/Heating		0.32 / 0.47	0.44 / 0.59	0.78 / 0.90	1.30 / 1.36	1.81 / 1.67
EER/COP			Cooling/Heating		6.25 / 5.74	5.68 / 5.42	4.49 / 4.78	3.85 / 4.41	3.37 / 4.07
Max. running current		A	9	9	9	15	15		
Sound power level	Indoor	Cooling/Heating	53 / 53	55 / 56	58 / 58	59 / 62	62 / 63		
	Outdoor		56 / 58	57 / 58	61 / 62	63 / 63	65 / 64		
Sound pressure level	Indoor	Cooling (Hi/Me/Lo/Ulo) Heating (Hi/Me/Lo/Ulo)	38 / 31 / 24 / 19	39 / 33 / 25 / 19	43 / 35 / 26 / 19	44 / 39 / 31 / 22	46 / 41 / 33 / 22		
	Outdoor		38 / 32 / 25 / 19	40 / 34 / 27 / 19	41 / 35 / 28 / 19	46 / 41 / 33 / 23	46 / 42 / 34 / 23		
Air flow	Indoor	Cooling (Hi/Me/Lo/Ulo) Heating (Hi/Me/Lo/Ulo)	11.3 / 9.1 / 6.0 / 5.0	12.2 / 10.0 / 6.7 / 5.0	13.1 / 10.8 / 7.3 / 5.0	14.3 / 12.4 / 7.8 / 5.4	16.3 / 13.4 / 8.9 / 5.4		
	Outdoor		12.2 / 10.3 / 7.2 / 5.4	12.8 / 11.0 / 7.8 / 5.4	13.9 / 11.8 / 8.6 / 5.4	17.3 / 14.3 / 9.8 / 6.2	17.8 / 13.7 / 10.9 / 6.2		
Exterior dimensions	Indoor	HeightxWidthxDepth	305 x 920 x 220						
	Outdoor		640 x 800(+71) x 290						
Net weight		Indoor / Outdoor	kg				13.0 / 43.0	13.0 / 45.0	
Refrigerant		Type/GWP	R410A / 2088						
		Charge	kg/CO ₂ Eq		1.45 / 3.028	1.50 / 3.132			
Refrigerant piping size		Liquid/Gas	ø mm				6.35(1/4") / 9.52(3/8")	6.35(1/4") / 12.7(1/2")	
Refrigerant line (one way) length [chargeless length]		m		Max.25 [15]			Max.30 [15]		
Vertical height differences		Outdoor is higher/lower	m		Max.15 / Max.15				
Outdoor operating temperature range		Cooling	-15~46						
		Heating	-20~24						
Clean filter		Allergen Clear Filter x 1, Photocatalytic Washable Deodorising Filter x 1							

* The data are measured under the following conditions(ISO-T1, H1). Cooling: Indoor temp. of 27°CDB, 19°CWB, and outdoor temp. of 35°CDB. Heating: Indoor temp. of 20°CDB, and outdoor temp. of 7°CDB, 6°CWB.

* Sound level indicates the value in an anechoic chamber. During operation these values are somewhat higher due to ambient conditions.

* 'tonne(s) of CO₂ equivalent' means a quantity of greenhouse gases- expressed as the product of the weight of the greenhouse gases in metric tonnes and of their global warming potential.



SINGLE-SPLIT WALL MOUNTED TYPE



SRK-ZR-S



SRK63ZR-S, SRK71ZR-S, SRK80ZR-S, SRK100ZR-S



OPTIONAL



Wireless remote control



SRK63ZR-S



SRK71ZR-S, SRC80ZR-S



FDC100VNP

KEY FEATURES

- All models has high energy class A⁺⁺
- Quiet Air Flow & Long Reach is achieved by jet technology
- Allergen clear operation cleans air, using a control scheme owned only by Mitsubishi Heavy Industries Thermal Systems
- Wireless interface control (optional)

SPECIFICATIONS

Indoor unit			SRK63ZR-S	SRK71ZR-S	SRK80ZR-S	SRK100ZR-S
Outdoor unit			SRK63ZR-S	SRK71ZR-S	SRK80ZR-S	FDC100VNP
Power source			1 Phase, 220 - 240V, 50Hz			
Nominal cooling capacity (Min~Max)		kW	6.3 (1.2~7.1)	7.1 (2.3~7.7)	8.0 (2.3~9.0)	10.0 (2.4~10.5)
Nominal heating capacity (Min~Max)		kW	7.1 (0.8~9.0)	8.0 (2.0~10.0)	9.0 (2.1~10.5)	11.2 (3.2~11.5)
Power consumption		Cooling/Heating	1.85 / 1.74	2.05 / 2.06	2.35 / 2.40	3.09 / 3.28
EER/COP		Cooling/Heating	3.41 / 4.08	3.46 / 3.88	3.40 / 3.75	3.24 / 3.41
Max. running current		A	14.5	17	17	21
Sound power level	Indoor	Cooling/Heating	58 / 58	58 / 60	62 / 62	63 / 63
	Outdoor	Cooling/Heating	67 / 66	65 / 63	68 / 67	70 / 74
Sound pressure level	Indoor	Cooling (Hi/Me/Lo/Ulo)	44 / 39 / 35 / 25	44 / 41 / 37 / 25	47 / 44 / 39 / 26	48 / 45 / 40 / 27
	Outdoor	Heating (Hi/Me/Lo/Ulo)	44 / 38 / 34 / 28	46 / 39 / 35 / 28	47 / 41 / 36 / 29	48 / 43 / 38 / 30
Air flow	Indoor	Cooling/Heating	54 / 54	53 / 51	56 / 55	57 / 61
	Outdoor	Cooling (Hi/Me/Lo/Ulo)	20.5 / 18.1 / 15.7 / 10.4	20.5 / 18.6 / 16.2 / 10.4	23.5 / 20.2 / 17.5 / 10.4	24.5 / 21.3 / 17.6 / 10.4
		Heating (Hi/Me/Lo/Ulo)	23.5 / 19.0 / 16.5 / 13.1	25.5 / 19.8 / 17.3 / 13.3	26.5 / 21.3 / 18.4 / 13.5	27.5 / 23.2 / 19.1 / 13.6
		Cooling/Heating	41.5 / 41.5	55 / 43.5	63 / 49.5	75 / 80
Exterior dimensions	Indoor	HeightxWidthxDepth	339 x 1197 x 262			
	Outdoor	HeightxWidthxDepth	640 x 800(+71) x 290	750 x 880(+88) x 340	845 x 970 x 370	
Net weight		Indoor / Outdoor	kg	15.5 / 45.0	15.5 / 57.0	16.5 / 58.5
					16.5 / 70.0	
Refrigerant		Type/GWP	R410A / 2088			
		Charge	kg/TCO ₂ Eq	1.55 / 3.236	1.8 / 3.758	1.9 / 3.967
Refrigerant piping size		Liquid/Gas	ø mm	6.35(1/4") / 12.7(1/2")	6.35(1/4") / 15.88(5/8")	9.52(3/8") / 15.88(5/8")
Refrigerant line (one way) length [chargeless length]		m	Max.30 [15]			
Vertical height differences		Outdoor is higher/lower	m	Max.20 / Max.20		
Outdoor operating temperature range		Cooling	°CDB	-15~46		
		Heating		-15~24		
Clean filter		Allergen Clear Filter x 1, Photocatalytic Washable Deodorising Filter x 1				

• The data are measured under the following conditions(ISO-T1, H1). Cooling: Indoor temp. of 27°CDB, 19°CWB, and outdoor temp. of 35°CDB. Heating: Indoor temp. of 20°CDB, and outdoor temp. of 7°CDB, 6°CWB.

• Sound level indicates the value in an anechoic chamber. During operation these values are somewhat higher due to ambient conditions.

• 'tonne(s) of CO₂ equivalent' means a quantity of greenhouse gases- expressed as the product of the weight of the greenhouse gases in metric tonnes and of their global warming potential.



SINGLE-SPLIT WALL MOUNTED TYPE

Premium Series

SRK-ZS-S



SRK20ZS-S, SRK25ZS-S, SRK35ZS-S, SRK50ZS-S Pure White(-S)

Colour variation available

Users can choose their favourite colour from three choices.



OPTIONAL



Black & White (-SB)



Titanium (-ST)



Wireless remote control



SRC20ZS-S, SRC25ZS-S, SRC35ZS-S



SRC50ZS-S

KEY FEATURES

- Elegant timeless design. Pick from three different colour choices
- Quiet Air Flow & Long Reach is achieved by jet technology
- Allergen clear operation cleans air, using a control scheme owned only by Mitsubishi Heavy Industries Thermal Systems
- Wireless interface control (optional)

SPECIFICATIONS

Indoor unit			SRK20ZS-S, -SB, -ST	SRK25ZS-S, -SB, -ST	SRK35ZS-S, -SB, -ST	SRK50ZS-S, -SB, -ST
Outdoor unit			SRC20ZS-S	SRC25ZS-S	SRC35ZS-S	SRC50ZS-S
Power source			1 Phase, 220 - 240V, 50Hz			
Nominal cooling capacity (Min~Max)		kW	2.0(1.0~2.8)	2.5(1.0~3.0)	3.5(1.0~3.8)	5.0(1.7~5.5)
Nominal heating capacity (Min~Max)		kW	2.7(0.9~4.2)	3.2(0.9~4.4)	4.0(0.9~4.8)	5.8(1.6~6.6)
Power consumption		Cooling/Heating	0.44 / 0.62	0.62 / 0.80	1.01 / 1.00	1.56 / 1.59
EER/COP		Cooling/Heating	4.55 / 4.35	4.03 / 4.00	3.47 / 4.00	3.21 / 3.65
Max. running current			9	9	9	14.5
Sound power level	Indoor	Cooling/Heating	50 / 52	52 / 55	56 / 58	58 / 59
	Outdoor	Cooling/Heating	57 / 57	58 / 58	62 / 61	62 / 63
Sound pressure level	Indoor	Cooling (Hi/Me/Lo/Ulo)	34 / 25 / 22 / 19	36 / 28 / 23 / 19	40 / 30 / 26 / 19	45 / 36 / 28 / 22
	Outdoor	Heating (Hi/Me/Lo/Ulo)	36 / 29 / 23 / 19	39 / 30 / 24 / 19	41 / 36 / 25 / 19	45 / 37 / 31 / 24
Air flow	Indoor	Cooling/Heating	45 / 45	46 / 46	50 / 48	51 / 53
	Outdoor	Cooling (Hi/Me/Lo/Ulo)	9.3 / 7.0 / 5.9 / 5.0	9.9 / 8.0 / 5.9 / 5.0	11.3 / 8.7 / 7.0 / 5.0	12.1 / 9.9 / 7.4 / 5.9
		Heating (Hi/Me/Lo/Ulo)	10.0 / 8.5 / 6.5 / 5.9	11.3 / 8.7 / 6.7 / 5.9	12.3 / 11.0 / 7.0 / 5.9	13.9 / 11.2 / 9.1 / 7.4
		Cooling/Heating	27.4 / 23.6	27.4 / 23.6	31.5 / 27.8	32.8 / 32.8
Exterior dimensions		Indoor	290 x 870 x 230			
		Outdoor	540 x 780(+62) x 290			595 x 780(+62) x 290
Net weight		Indoor / Outdoor	9.5 / 31.5		9.5 / 34.5	10.0 / 36.5
Refrigerant		Type/GWP	R410A / 2088			
		Charge	0.75 / 1.566		0.95 / 1.984	1.25 / 2.61
Refrigerant piping size		Liquid/Gas	6.35(1/4") / 9.52(3/8")			6.35(1/4") / 12.7(1/2")
Refrigerant line (one way) length [chargeless length]		ø mm	Max. 20 [15]			Max. 25 [15]
Vertical height differences		Outdoor is higher/lower	Max. 10 / Max. 10			Max. 15 / Max. 15
Outdoor operating temperature range		Cooling	-15~46			
		Heating	-15~24			
Clean filter			Allergen Clear Filter x 1, Photocatalytic Washable Deodorising Filter x 1			

* The data are measured under the following conditions(ISO-T1, H1). Cooling: Indoor temp. of 27°CDB, 19°CWB, and outdoor temp. of 35°CDB. Heating: Indoor temp. of 20°CDB, and outdoor temp. of 7°CDB, 6°CWB.

* Sound level indicates the value in an anechoic chamber. During operation these values are somewhat higher due to ambient conditions.

* 'tonne(s) of CO₂ equivalent' means a quantity of greenhouse gases- expressed as the product of the weight of the greenhouse gases in metric tonnes and of their global warming potential.



SINGLE-SPLIT WALL MOUNTED TYPE



SRK-ZSP-S



SRK25ZSP-S, SRK35ZSP-S, SRK45ZSP-S



Wireless remote control



SRC25ZSP-S, SRC35ZSP-S



SRC45ZSP-S

KEY FEATURES

- ZSP series has an elegant design that fits into any kind of interior decoration
- Compact and lightweight feature of outdoor unit offers great installation flexibility
- Self-cleaning operation helps keep the room air clean
- Useful timer function that can turn on and turn off the air conditioners in a pre-set time

SPECIFICATIONS

Indoor unit			SRK25ZSP-S	SRK35ZSP-S	SRK45ZSP-S
Outdoor unit			SRC25ZSP-S	SRC35ZSP-S	SRC45ZSP-S
Power source			1 Phase, 220 - 240V, 50Hz		
Nominal cooling capacity (Min~Max)		kW	2.5(0.9~2.8)	3.2(0.9~3.5)	4.5(0.9~4.8)
Nominal heating capacity (Min~Max)		kW	2.8(0.8~3.9)	3.6(0.9~4.3)	5.0(0.8~5.8)
Power consumption		kW	0.78 / 0.755	0.995 / 0.995	1.495 / 1.385
EER/COP			3.21/3.71	3.22 / 3.62	3.01 / 3.61
Max. running current		A	9	9	14
Sound power level	Indoor	Cooling/Heating	58 / 57	59 / 58	58 / 62
	Outdoor	Cooling/Heating	58 / 59	60 / 60	63 / 64
Sound pressure level	Indoor	Cooling (Hi/Me/Lo)	45 / 34 / 23	45 / 36 / 23	44 / 39 / 24
		Heating (Hi/Me/Lo)	43 / 34 / 26	44 / 36 / 28	48 / 41 / 30
	Outdoor	Cooling/Heating	47 / 45	47 / 48	51 / 51
Air flow	Indoor	Cooling (Hi/Me/Lo)	10.0 / 7.3 / 4.2	9.5 / 6.8 / 4.2	9.0 / 7.2 / 3.8
		Heating (Hi/Me/Lo)	9.5 / 7.3 / 5.2	9.6 / 7.4 / 5.5	12.0 / 9.2 / 6.2
	Outdoor	Cooling/Heating	26.0 / 19.7	25.4 / 20.5	35.5 / 33.5
Exterior dimensions	Indoor	HeightxWidthxDepth	267 x 783 x 210		
	Outdoor		540 x 645(+57) x 275	595 x 780(+62) x 290	
Net weight		Indoor / Outdoor	7.0 / 25.0	7.0 / 27.0	7.5 / 40.0
Refrigerant		Type/GWP	R410A / 2088		
		Charge	0.655 / 1.368	0.81 / 1.691	1.20 / 2.506
Refrigerant piping size		Liquid/Gas	6.35(1/4") / 9.52(3/8")		
Refrigerant line (one way) length [chargeless length]		m	Max. 15 [10]	Max. 15 [Not required]	Max. 25 [15]
Vertical height differences		Outdoor is higher/lower	Max. 10 / Max. 10		Max. 15 / Max. 15
Outdoor operating temperature range		Cooling	-15~46		
		Heating	-15~24		
Clean filter			-		

* The data are measured under the following conditions (ISO-T1, H1). Cooling: Indoor temp. of 27°CDB, 19°CWB, and outdoor temp. of 35°CDB. Heating: Indoor temp. of 20°CDB, and outdoor temp. of 7°CDB, 6°CWB.

* Sound level indicates the value in an anechoic chamber. During operation these values are somewhat higher due to ambient conditions.

* 'tonne(s) of CO₂ equivalent' means a quantity of greenhouse gases- expressed as the product of the weight of the greenhouse gases in metric tonnes and of their global warming potential.



SINGLE-SPLIT FLOOR STANDING TYPE

SRF-ZMX

Auto air outlet selection

In case both lower and upper air outlets can be selected.



SRF25ZMX-S, SRF35ZMX-S,
SRF50ZMX-S

Installation workability

Piping and drain hose connection can be selected out of 6-directions.

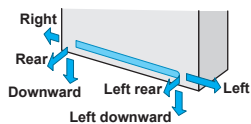

Wireless
remote control



SRC25ZMX-S, SRC35ZMX-S



SRC50ZSX-S

KEY FEATURES

- The elegant semi flat front panel in stylish white, fit various kinds of rooms and create relaxing atmosphere
- Choice from wall hanging, floor standing or behind gallery installation
- Quiet operation. By optimising the balance of the air outlet direction and the sufficient air flow volume, the sound level has been minimised
- The "flap control system" allows users to change flap angles and positions according to their preference. Flaps can be set at different angles
- Allergen clear filter is equipped as a default

SPECIFICATIONS

Indoor unit			SRF25ZMX-S	SRF35ZMX-S	SRF50ZMX-S
Outdoor unit			SRC25ZMX-S	SRC35ZMX-S	SRC50ZSX-S
Power source			1 Phase, 220 - 240V, 50Hz		
Nominal cooling capacity (Min~Max)		kW	2.5 (0.9~3.2)	3.5 (0.9~4.1)	5.0 (1.1~5.2)
Nominal heating capacity (Min~Max)		kW	3.4 (0.9~4.7)	4.5 (0.9~5.1)	6.0 (0.6~6.9)
Power consumption		Cooling/Heating	0.521 / 0.723	0.890 / 1.124	1.390 / 1.540
EER/COP		Cooling/Heating	4.80 / 4.70	3.93 / 4.00	3.60 / 3.90
Max. running current		A	8	8	15
Sound power level	Indoor	Cooling/Heating	51 / 51	52 / 52	58 / 58
	Outdoor	Cooling/Heating	60 / 60	63 / 62	63 / 62
Sound pressure level	Indoor	Cooling (Hi/Me/Lo/Ulo)	40 / 32 / 30 / 26	41 / 34 / 33 / 28	46 / 42 / 35 / 32
		Heating (Hi/Me/Lo/Ulo)	40 / 35 / 33 / 28	41 / 36 / 35 / 31	47 / 41 / 39 / 33
	Outdoor	Cooling/Heating	47 / 47	50 / 50	52 / 51
		Cooling/Heating	9.0 / 7.6 / 6.7 / 5.8	9.2 / 7.8 / 7.3 / 6.4	11.5 / 9.6 / 7.4 / 6.6
Air flow	Indoor	Heating (Hi/Me/Lo/Ulo)	10.5 / 8.2 / 7.7 / 6.6	10.7 / 8.3 / 8.1 / 7.4	12.0 / 10.0 / 9.4 / 7.6
		Cooling/Heating	29.5 / 27.0	32.5 / 29.5	39.0 / 33.0
	Outdoor	Cooling/Heating	600 x 860 x 238		
Exterior dimensions	Indoor	HeightxWidthxDPTH	595 x 780(+62) x 290		
	Outdoor	HeightxWidthxDPTH	19.0 / 35.0		640 x 800(+71) x 290
Net weight		Indoor / Outdoor	18.0 / 35.0		19.0 / 45.0
Refrigerant		Type/GWP	R410A / 2088		
		Charge	1.2 / 2.506		1.5 / 3.132
Refrigerant piping size		Liquid/Gas	6.35(1/4") / 9.52(3/8")		6.35(1/4") / 12.7(1/2")
Refrigerant line (one way) length [chargeless length]		m	Max. 15 [Not required]		Max. 30 [15]
Vertical height differences		Outdoor is higher/lower	Max. 10 / Max. 10		Max. 20 / Max. 20
Outdoor operating temperature range	Cooling	°CDB	-15~24		-15~46
	Heating	°CDB			-20~24
Clean filter			Allergen Clear Filter x 1 Photocatalytic Washable Deodorising Filter x 1		

* The data are measured under the following conditions(ISO-T1, H1). Cooling: Indoor temp. of 27°CDB, 19°CWB, and outdoor temp. of 35°CDB. Heating: Indoor temp. of 20°CDB, and outdoor temp. of 7°CDB, 6°CWB.

* Sound level indicates the value in an anechoic chamber. During operation these values are somewhat higher due to ambient conditions.

* 'tonne(s) of CO₂ equivalent' means a quantity of greenhouse gases- expressed as the product of the weight of the greenhouse gases in metric tonnes and of their global warming potential.



SINGLE-SPLIT CEILING CONCEALED TYPE

SRR-ZM

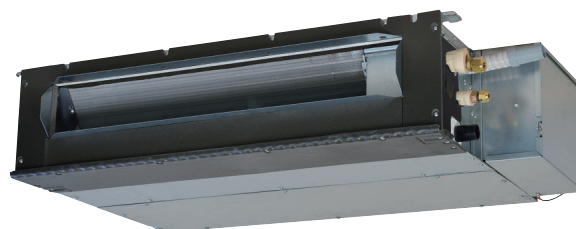

SRR25ZM-S, SRR35ZM-S

Bottom air inlet kit (option)

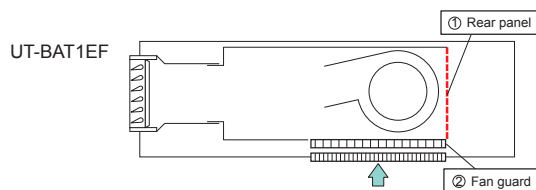

Wireless remote control



SRC25ZMX-S, SRC35ZMX-S

KEY FEATURES

- Thin design, the height of all SRR models is only 200mm. The indoor unit is completely hidden in the ceiling, so this is suitable for spaces with classy interior decoration
- Lower noise
- Low Static Pressure Level
- The SRR series come with a built in drain pump

SPECIFICATIONS

Indoor unit				SRR25ZM-S	SRR35ZM-S
Outdoor unit				SRC25ZMX-S	SRC35ZMX-S
Power source				1 Phase, 220 - 240V, 50Hz	
Nominal cooling capacity (Min~Max)		kW		2.5 (1.0 ~ 3.3)	3.5 (1.0 ~ 3.9)
Nominal heating capacity (Min~Max)		kW		3.4 (1.4 ~ 4.8)	4.2 (1.5 ~ 5.2)
Power consumption		kW		Cooling/Heating 0.570 / 0.750	0.980 / 1.030
EER/COP		Cooling/Heating		4.39 / 4.53	3.57 / 4.08
Max. running current		A		8	
Sound power level	Indoor	Cooling/Heating	dB(A)	56 / 59	57 / 60
	Outdoor	Cooling/Heating		60 / 60	62 / 62
Sound pressure level	Indoor	Cooling (Hi/Me/Lo/Ulo)		37 / 33 / 30 / 24	38 / 34 / 31 / 25
		Heating (Hi/Me/Lo/Ulo)		40 / 37 / 34 / 28	41 / 38 / 35 / 29
	Outdoor	Cooling/Heating	47 / 47	50 / 50	
		Cooling (Hi/Me/Lo/Ulo)	9.5 / 8.0 / 6.5 / 4.5	10.0 / 8.5 / 7.0 / 5.0	
Air flow	Indoor	Heating (Hi/Me/Lo/Ulo)	10.0 / 9.0 / 8.0 / 6.0	10.5 / 9.5 / 8.5 / 6.5	
		Cooling/Heating	29.5 / 27.0	32.5 / 29.5	
	Outdoor	Cooling/Heating	29.5 / 27.0	32.5 / 29.5	
External static pressure		Pa		Standard : 5*1(Initial static pressure with air filter : 5Pa)	
Exterior dimensions	Indoor	HeightxWidthxDepth	mm	200 x 750 x 500	
	Outdoor			595 x 780(+62) x 290	
Net weight		Indoor / Outdoor		kg	
				20.5 / 35.0	
Refrigerant		Type/GWP		R410A / 2088	
		Charge		kg/TCO ₂ Eq	
				1.2 / 2.506	
Refrigerant piping size		Liquid/Gas		ø mm	
				6.35(1/4") / 9.52(3/8")	
Refrigerant line (one way) length[chargeless length]		m		Max. 15 [Not required]	
Vertical height differences		Outdoor is higher/lower		m	
				Max. 10 / Max.10	
Outdoor operating temperature range		Cooling		°CDB	
		Heating		-15~46	
				-15~24	
Bottom air inlet kit (option)				UT-BAT1EF	

* The data are measured under the following conditions(ISO-T1, H1). Cooling: Indoor temp. of 27°CDB, 19°CWB, and outdoor temp. of 35°CDB. Heating: Indoor temp. of 20°CDB, and outdoor temp. of 7°CDB, 6°CWB.

• Sound level indicates the value in an anechoic chamber. During operation these values are somewhat higher due to ambient conditions.

• 'tonne(s) of CO₂ equivalent' means a quantity of greenhouse gases- expressed as the product of the weight of the greenhouse gases in metric tonnes and of their global warming potential.

*1 The maximum external static pressure can be used up to 35Pa, but the airflow will be reduced.



SINGLE-SPLIT 4WAY CEILING CASSETTE TYPE

FDTC-VF

FDTC25VF, FDTC35VF, FDTC40VF,
FDTC50VF, FDTC60VF

Fits into standard
600x600 ceiling



Individual flap control system

According to room temperature conditions, four directions of air flow can be controlled by individual flap as preferred. Individual flap control is available even after installation.



600mm Drain Pump is mounted

Drain can be discharged upward by 600mm from the ceiling surface close to the indoor unit.

It allows a piping layout with a high degree of freedom depending on the installation location.

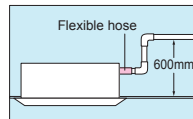

Wired remote control (optional)



Wireless remote control (optional)



SRC25ZMX-S, SRC35ZMX-S



SRC40ZSX-S, SRC50ZSX-S,
SRC60ZSX-S

KEY FEATURES

- Compact and extra thin design
- The flap can swing within the range of upper and lower flap position selected with the wired remote control
- For wireless control, simply insert the infrared receiver kit on the corner of the panel
- FDTC-VF series come with a built in 600mm drain pumps

SPECIFICATIONS

Indoor unit				FDTC25VF	FDTC35VF	FDTC40VF	FDTC50VF	FDTC60VF	
Outdoor unit				SRC25ZMX-S	SRC35ZMX-S	SRC40ZSX-S	SRC50ZSX-S	SRC60ZSX-S	
Power source				1 Phase, 220 - 240V, 50Hz					
Nominal cooling capacity (Min~Max)		kW		2.55 (0.9 ~ 3.2)	3.6 (0.9 ~ 4.1)	4.0 (1.1 ~ 4.7)	5.0 (1.1 ~ 5.6)	5.6 (1.1 ~ 6.3)	
Nominal heating capacity (Min~Max)		kW		3.45 (0.9 ~ 4.7)	4.25 (0.9 ~ 5.1)	4.5 (0.6 ~ 5.4)	5.4 (0.6 ~ 6.3)	6.7 (0.6 ~ 6.7)	
Power consumption		Cooling/Heating	kW	0.6 / 0.84	1.07 / 1.16	1.04 / 1.10	1.56 / 1.45	1.99 / 2.07	
EER/COP				Cooling/Heating	4.25 / 4.11	3.36 / 3.66	3.85 / 4.09	3.21 / 3.72	2.81 / 3.24
Max. running current			A	8	8	12	15	15	
Sound power level	Indoor	Cooling/Heating	dB(A)	56 / 56	58 / 58	60 / 60	60 / 60	60 / 60	
	Outdoor	Cooling/Heating		56 / 56	58 / 58	63 / 63	63 / 63	65 / 65	
Sound pressure level	Indoor	Cooling (P-Hi/Hi/Me/Lo)		38 / 36 / 32 / 29	41 / 40 / 36 / 30	47 / 42 / 36 / 30	47 / 42 / 36 / 30	47 / 46 / 39 / 30	
	Outdoor	Heating (P-Hi/Hi/Me/Lo)		39 / 38 / 33 / 29.5	43 / 42 / 35 / 32	47 / 42 / 36 / 32	47 / 42 / 36 / 32	47 / 46 / 39 / 32	
Air flow	Indoor	Cooling (P-Hi/Hi/Me/Lo)	m³/min	10 / 9 / 8 / 6.5	11 / 9.5 / 9 / 7	13.5 / 11.5 / 9 / 7	13.5 / 11.5 / 9 / 7	13.5 / 13.5 / 10 / 7	
	Outdoor	Heating (P-Hi/Hi/Me/Lo)		10.5 / 9.5 / 8.5 / 7	11.5 / 10 / 9 / 8	13.5 / 11.5 / 9 / 8	13.5 / 11.5 / 9 / 8	13.5 / 13.5 / 10 / 8	
Exterior dimensions	Indoor	HeightxWidthxDepth		mm	Unit : 248 x 570 x 570 Panel : 35 x 700 x 700				
	Outdoor				595 x 780(+62) x 290		640 x 800(+71) x 290		
Net weight		Indoor / Outdoor	kg	18.5 (Unit : 15 Panel : 3.5) / 35.0			18.5 (Unit : 15 Panel : 3.5) / 45.0		
Refrigerant		Type/GWP		R410A / 2088					
		Charge	kg/TCO ₂ Eq	1.2 / 2.506			1.5 / 3.132		
Refrigerant piping size		Liquid/Gas	ø mm	6.35(1/4") / 9.52(3/8")			6.35(1/4") / 12.7(1/2")		
Refrigerant line (one way) length [chargeless length]			m	Max. 15 [Not required]			Max. 30 [15]		
Vertical height differences		Outdoor is higher/lower	m	Max. 10 / Max.10			Max. 20 / Max.20		
Outdoor operating temperature range		Cooling	°CDB	-15~24			-15~46		
		Heating							
Panel				TC-PSA-25W-E					

* The data are measured under the following conditions (ISO-T1, H1). Cooling: Indoor temp. of 27°CDB, 19°CWB, and outdoor temp. of 35°CDB. Heating: Indoor temp. of 20°CDB, and outdoor temp. of 7°CDB, 6°CWB.
 * Sound level indicates the value in an anechoic chamber. During operation these values are somewhat higher due to ambient conditions.
 * 'tonne(s) of CO₂ equivalent' means a quantity of greenhouse gases- expressed as the product of the weight of the greenhouse gases in metric tonnes and of their global warming potential.

MULTI-SPLIT SCM

The Multi DC Inverter range is an innovative Multi-split systems from Mitsubishi Heavy Industries Thermal Systems which offers the perfect answer for air conditioning comfort in several environments. An outdoor unit can air condition up to 6 different rooms. Utilising a range of compact and elegant indoor units that are available in 6 different types make air conditioning in any indoor environment possible. The whole range is characterised by high flexibility, high energy efficiency and extremely low noise levels.



FDTC
4way Ceiling
Cassette type



FDE
Ceiling
Suspended type



SRK/SKM
Wall
Mounted type

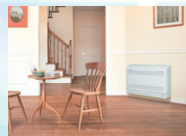

SRF
Floor
Standing type



SRR
Ceiling
Concealed type



FDUM
Duct
Connected type



A wide variety of choices for indoor units





MULTI-SPLIT SYSTEM

Various line up of High energy efficient models

The small capacity models have been added to the energy efficient R32 lineup. The added models is connectable to small capacity indoor units for 2~3 rooms



SCM30ZS-W
SCM40ZS-W
SCM45ZS-W

SCM41ZS-W
SCM50ZS-W
SCM60ZS-W

SCM71ZS-W
SCM80ZS-W

SCM100ZS-W

Higher efficiency

SEER in Cooling A+++ (except 71/80ZS-W)

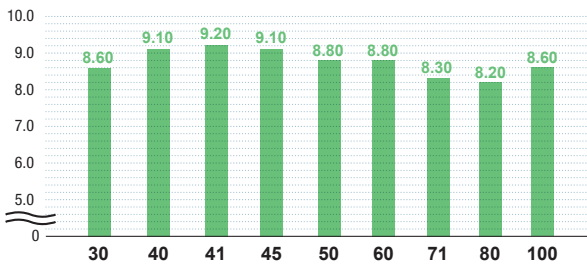

SCOP in Heating A++ (except 100ZS-W)

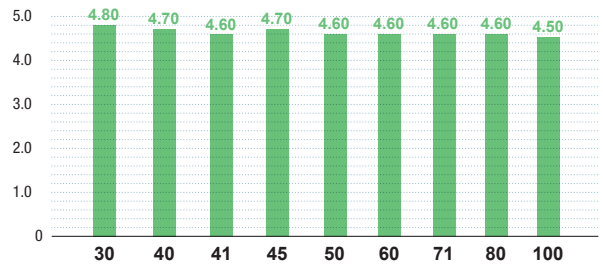

* The above values are based on indoor units combination with SRK-ZSX-W only. SCM30ZS-W, SCM41ZS-W and SCM100ZS-W are calculated in the combination with SRK-ZS-W.

Comfort

By the application of the Twin Rotary compressor*, the outdoor units have low noise levels. Silent operation is installed in all outdoor units.

* except 30/41ZS-W

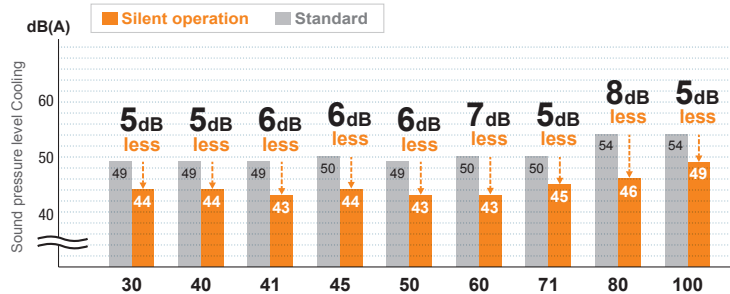

Wide Range of Operation

Our new advanced technology has expanded the heating and cooling operation range. Expand the cooling range of all model to 46°C.

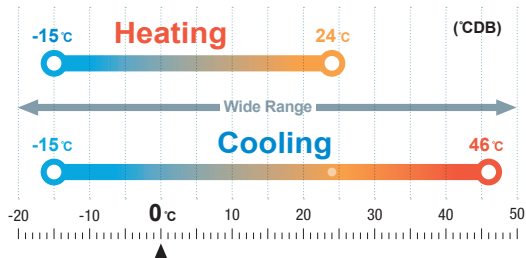

Installation Flexibility

You are given greater freedom to decide where the indoor units will be installed to optimise interior space and convenience.

	SCM30ZS-W	SCM40/45ZS-W	SCM41/50/60ZS-W	SCM71/80ZS-W	SCM100ZS-W
length for one indoor unit	under 25m	under 25m	under 25m	under 25m	under 25m
total length for all rooms	under 30m	under 30m	under 40m	under 70m	under 75m
height difference	lower installation spot of the indoor unit	under 15m	under 15m	under 20m	under 20m
	upper installation spot of the indoor unit	under 15m	under 15m	under 20m	under 20m
	maximum height difference of the indoor units	under 25m	under 25m	under 25m	under 25m
length of chargeless refrigerant pipe	30m	20m	40m	30m	40m

■ SPECIFICATIONS

Item	Model	For two rooms			For three rooms			
		SCM30ZS-W	SCM40ZS-W	SCM45ZS-W	SCM41ZS-W	SCM50ZS-W	SCM60ZS-W	
Power Source		1Phase, 220 - 240V, 50Hz						
Nominal cooling capacity (Min~Max)	kW	3.0(1.4~5.0)	4.0(1.5~5.9)	4.5(1.5~6.4)	4.0(1.4~6.3)	5.0(1.7~7.1)	6.0(1.7~7.5)	
Nominal heating capacity (Min~Max)	kW	4.0(1.0~5.7)	4.5(1.0~6.3)	5.3(1.0~6.5)	4.5(1.0~6.9)	6.0(1.0~7.5)	6.8(1.0~7.8)	
Power Consumption	Cooling	kW	0.52(0.32~1.60)	0.80(0.34~2.10)	0.96(0.34~2.30)	0.72(0.32~1.65)	1.02(0.43~2.15)	1.32(0.43~2.28)
	Heating	kW	0.74(0.25~1.49)	0.83(0.25~1.48)	1.06(0.25~1.48)	0.81(0.25~1.58)	1.16(0.32~2.50)	1.40(0.32~2.80)
EER	Cooling		5.77	5.00	4.69	5.56	4.90	4.55
COP	Heating		5.41	5.42	5.00	5.56	5.17	4.86
Max. running current	A		14	14	14	15	15	15
Sound power level	Cooling	dB(A)	62	62	63	62	62	62
	Heating	dB(A)	64	64	65	64	64	64
Sound pressure level	Cooling	dB(A)	49	49	50	49	49	50
	Heating	dB(A)	51	51	52	52	52	52
Air flow	Cooling	m ³ /min	32.5	32.5	32.5	41.0	41.0	41.0
	Heating	m ³ /min	32.5	32.5	32.5	41.0	41.0	41.0
Exterior dimensions (H×W×D)	mm	595×780(+90)×290			640×850(+65)×290			
Net weight	kg	35.5	40.0		42.5	48.5		
Refrigerant	Type/GWP	R32/675						
	Charge	kg/TCO ₂ Eq	1.25/0.843	1.4/0.945		1.6/1.08	1.8/1.215	
Refrigerant piping size	Liquid	Φmm	6.35(1/4")×2			6.35(1/4")×3		
	Gas	Φmm	9.52(3/8")×2			9.52(3/8")×3		
Outdoor operating temperature range	Cooling	°CDB	-15~46					
	Heating	°CDB	-15~24					
Number of Connectable indoor units		2	2	2	Min.2~Max.3	Min.2~Max.3	Min.2~Max.3	
Total indoor units capacity	kW	3.0 ~ 5.0	4.0 ~ 6.0	4.5 ~ 7.0	4.0 ~ 7.0	5.0 ~ 8.5	6.0 ~ 11.0	

Item	Model	For four rooms		For five rooms	
		SCM71ZS-W	SCM80ZS-W	SCM100ZS-W	
Power Source		1Phase, 220 - 240V, 50Hz			
Nominal cooling capacity (Min~Max)	kW	7.1(1.8~8.8)	8.0(1.8~9.2)	10.0(1.7~11.5)	
Nominal heating capacity (Min~Max)	kW	8.6(1.1~9.4)	9.3(1.1~9.8)	10.5(0.9~11.5)	
Power Consumption	Cooling	kW	1.42(0.48~2.75)	1.70(0.48~2.83)	2.70(0.48~3.65)
	Heating	kW	1.75(0.35~3.00)	1.95(0.35~3.12)	2.38(0.37~2.90)
EER	Cooling		5.00	4.71	3.70
COP	Heating		4.91	4.77	4.41
Max. running current	A		20	20	21
Sound power level	Cooling	dB(A)	63	66	67
	Heating	dB(A)	67	67	72
Sound pressure level	Cooling	dB(A)	50	54	54
	Heating	dB(A)	54	54	59
Air flow	Cooling	m ³ /min	50.0	56.0	75.0
	Heating	m ³ /min	56.0	56.0	75.0
Exterior dimensions (H×W×D)	mm	750×880(+73)×340		945×970×370	
Net weight	kg	61.0		73.0	
Refrigerant	Type/GWP	R32/675			
	Charge	kg/TCO ₂ Eq	2.55/1.721		2.98/2.012
Refrigerant piping size	Liquid	Φmm	6.35(1/4")×4		6.35(1/4")×5
	Gas	Φmm	9.52(3/8")×4		9.52(3/8")×5
Outdoor operating temperature range	Cooling	°CDB	-15~46		
	Heating	°CDB	-15~24		
Number of Connectable indoor units		Min.2~Max.4	Min.2~Max.4	Min.2*~Max.5*	
Total indoor units capacity	kW	7.0 ~ 12.5	8.0 ~ 13.5	9.0 ~ 16.0*	

* The data are measured under the following conditions(ISO-T1, H1). Cooling: Indoor temp. of 27°CDB, 19°CWB, and outdoor temp. of 35°CDB. Heating: Indoor temp. of 20°CDB, and outdoor temp. of 7°CDB, 6°CWB.

* Sound level Indicates the value in an anechoic chamber. During operation these values are somewhat higher due to ambient conditions.

* 'tonne(s) of CO₂ equivalent' means a quantity of greenhouse gases- expressed as the product of the weight of the greenhouse gases in metric tonnes and of their global warming potential.

* Only the following combinations are possible. The total connecting capacity of indoor units should be between 90 ~ 160.

[2 indoor units can be connectable]

- Includes 1 or more SRK-ZR
- SRK-ZSX x 2
- SRK-ZSX + FDE50
- SRK-ZSX + SRF35,50
- FDE50 + SRF50

[5 indoor unit can be connectable]

Only the following A and B combinations are possible.

A. The total number of (SRK-ZSX, SRF 35,50, FDE 50) is 4 or less.

5 units can be connected by connecting other indoor units.

Example: ZSX x 4 + ZS x 1 are possible.

B. When connecting 146 - 160, the following combinations are not applicable.

Indoor unit combination: Total 151(20+20+20+20+71), Total 160(20+20+20+20+80),

Total 156 (20+20+20+25+71), Total 160 (20+20+20+50+50).

[3 or 4 indoor unit can be connectable]

- No limitation



MULTI-SPLIT SYSTEM

Outdoor Units

Powerful, efficient and silent outdoor units are available in 8 sizes and able to combine up to 6 indoor units.

SCM40ZS-S
SCM45ZS-S



SCM71ZM-S1
SCM80ZM-S1



SCM50ZS-S1
SCM60ZM-S1



SCM100ZM-S
SCM125ZM-S



Energy saving

All models can achieve very high seasonal efficiency due to the application of inverter technology which makes it possible to vary the power output according to demand for cooling or heating. This makes it possible to reach the set temperature quickly and to keep it stable over time saving about 30% in consumption compared to traditional fixed speed air conditioners.

SEER in Cooling

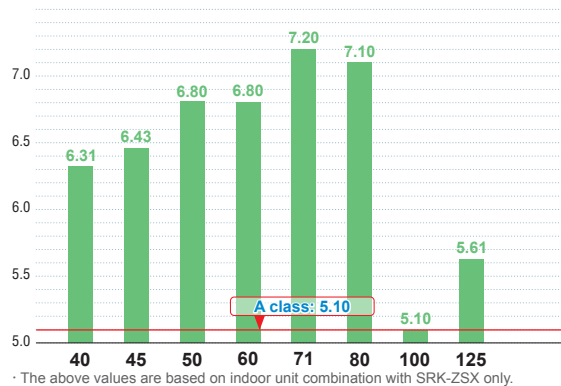

SCOP in Heating



Comfort

By the application of the Twin Rotary compressor, the outdoor units have low noise levels.

All the units also operate in heating and cooling mode with an outdoor temperature limit of -15°C.

Silent operation is newly installed in SCM50, 60, 71, 80 type.

Installation Flexibility

With a generous maximum piping length of 90m*, you are given greater freedom to decide where the indoor units will be installed to optimise interior space and convenience.

	SCM40/45ZS-S	SCM50ZS-S1/SCM60ZM-S1	SCM71/80ZM-S1	SCM100/125ZM-S
length for one indoor unit	under 25m	under 25m	under 25m	under 25m
total length for all rooms	under 30m	under 40m	under 70m	under 90m*
height difference	lower installation spot of the indoor unit (A)	under 15m	under 20m	under 20m
	upper installation spot of the indoor unit (B)	under 15m	under 20m	under 20m
	maximum height difference of the indoor units (C)	under 25m	under 25m	under 25m
length of chargeless refrigerant pipe	30m	40m	40m	50m

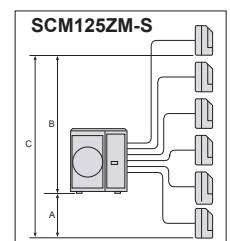

■ SPECIFICATIONS

Item	Model	For two rooms		For three rooms		
		SCM40ZS-S	SCM45ZS-S	SCM50ZS-S1	SCM60ZM-S1	
Power Source		1Phase, 220 - 240V, 50Hz				
Nominal cooling capacity (Min~Max)	kW	4.0(1.5~5.9)	4.5(1.5~6.4)	5.0(1.8~7.1)	6.0(1.8~7.5)	
Nominal heating capacity (Min~Max)	kW	4.5(1.3~6.3)	5.3(1.3~6.5)	6.0(1.4~7.5)	6.8(1.5~7.8)	
Power Consumption	Cooling	kW	0.84(0.59~2.13)	1.04(0.59~2.30)	1.05(0.60~2.15)	1.43(0.50~2.39)
	Heating	kW	0.90(0.54~1.70)	1.15(0.54~1.92)	1.21(0.55~2.58)	1.45(0.60~3.00)
EER	Cooling		4.76	4.33	4.76	4.20
COP	Heating		5.00	4.61	4.96	4.69
Max. running current	A		14	14	14	17
Sound power level	Cooling	dB(A)	62	62	61	63
	Heating	dB(A)	64	64	63	65
Sound pressure level	Cooling	dB(A)	48	49	48	50
	Heating	dB(A)	50	51	50	52
Air flow	Cooling	m ³ /min	32.5	32.5	41.0	42.0
	Heating		32.5	32.5	41.0	42.0
Exterior dimensions (H×W×D)	mm	595×780(+90)×290		640×850(+65)×290		
Net weight	kg	42.0		49.0	49.5	
Refrigerant	Type/GWP	R410A/2088				
	Charge	kg/TCO ₂ Eq	1.9/3.967		2.5/5.22	
Refrigerant piping size	Liquid	Φmm	6.35(1/4")×2		6.35(1/4")×3	
	Gas		9.52(3/8")×2		9.52(3/8")×3	
Outdoor operating temperature range	Cooling	°CDB	-15~43			
	Heating		-15~24			
Number of Connectable indoor units		2	2	Min.2~Max.3	Min.2~Max.3	
Total indoor units capacity	kW	6.0	7.0	8.5	11.0	

Item	Model	For four rooms		For five/six rooms		
		SCM71ZM-S1	SCM80ZM-S1	SCM100ZM-S	SCM125ZM-S	
Power Source		1Phase, 220 - 240V, 50Hz				
Nominal cooling capacity (Min~Max)	kW	7.1(1.8~8.8)	8.0(1.8~9.2)	10.0(1.8~12.0)	12.5(1.8~14.0)	
Nominal heating capacity (Min~Max)	kW	8.6(1.5~9.4)	9.3(1.5~9.8)	12.0(1.5~13.5)	13.5(1.5~14.0)	
Power Consumption	Cooling	kW	1.58(0.48~2.75)	1.95(0.48~2.83)	2.86(0.65~4.03)	3.90(0.65~4.80)
	Heating	kW	2.00(0.60~3.35)	2.26(0.60~3.43)	2.93(0.70~3.40)	3.25(0.70~3.42)
EER	Cooling		4.49	4.10	3.50	3.21
COP	Heating		4.30	4.12	4.10	4.15
Max. running current	A		20	20	29	29
Sound power level	Cooling	dB(A)	63	66	68	69
	Heating	dB(A)	66	66	71	72
Sound pressure level	Cooling	dB(A)	50	54	56	57
	Heating	dB(A)	54	54	59	60
Air flow	Cooling	m ³ /min	50.0	56.0	75.0	75.0
	Heating		56.0	56.0	75.0	82.0
Exterior dimensions (H×W×D)	mm	750×880(+73)×340		945×970(+73)×370		
Net weight	kg	62.0		92.0		
Refrigerant	Type/GWP	R410A/2088				
	Charge	kg/TCO ₂ Eq	3.15/6.577		6.0/12.528	
Refrigerant piping size	Liquid	Φmm	6.35(1/4")×4		6.35(1/4")×5	6.35(1/4")×6
	Gas		9.52(3/8")×4		9.52(3/8")×5	9.52(3/8")×6
Outdoor operating temperature range	Cooling	°CDB	-15~43			
	Heating		-15~24			
Number of Connectable indoor units		Min.2~Max.4	Min.2~Max.4	Min.4*~Max.5	Min.4*~Max.6	
Total indoor units capacity	kW	12.5	13.5	16.0	19.5	

* The data are measured under the following conditions(ISO-T1, H1). Cooling: Indoor temp. of 27°CDB, 19°CWB, and outdoor temp. of 35°CDB. Heating: Indoor temp. of 20°CDB, and outdoor temp. of 7°CDB, 6°CWB.

* Sound level Indicates the value in an anechoic chamber. During operation these values are somewhat higher due to ambient conditions.

* 'tonne(s) of CO₂ equivalent' means a quantity of greenhouse gases- expressed as the product of the weight of the greenhouse gases in metric tonnes and of their global warming potential.

* In case of SRK71ZR+SRK71ZR, 2 Indoor units can be connectable. In case of the combination with SRK-ZSX, SRK71ZR & FDE50VH, only 3 indoor units can be connectable. The total connecting capacity of indoor units should be between 100 ~ 160. (SCM100ZM-S, SCM125ZM-S)



MULTI-SPLIT SYSTEM

INDOOR UNITS SPECIFICATION FOR MULTI COMBINATIONS

Wall Mounted

SRK-ZSX



Item	Model	SRK20ZSX-WF*, -W	SRK25ZSX-WF*, -W	SRK35ZSX-WF*, -W	SRK50ZSX-WF*, -W	SRK60ZSX-WF*, -W	
Nominal cooling capacity	kW	2.0	2.5	3.5	5.0	6.0	
Nominal heating capacity	kW	3.0	3.4	4.5	5.8	6.8	
Sound power level	Cooling	dB(A)	53	55	58	59	62
	Heating	dB(A)	55	56	58	62	63
Sound pressure level	Cooling(Hi/Me/Lo/Ulo)	dB(A)	38 / 31 / 24 / 19	39 / 33 / 25 / 19	43 / 35 / 26 / 19	44 / 39 / 31 / 22	48 / 41 / 33 / 22
	Heating(Hi/Me/Lo/Ulo)	dB(A)	38 / 33 / 25 / 19	40 / 34 / 27 / 19	42 / 35 / 28 / 19	47 / 41 / 33 / 23	47 / 42 / 34 / 23
Air flow	Cooling(Hi/Me/Lo/Ulo)	m ³ /min	11.3 / 9.1 / 6.0 / 5.0	12.2 / 10.0 / 6.7 / 5.0	13.1 / 10.8 / 7.3 / 5.0	14.3 / 12.4 / 7.8 / 5.4	16.3 / 13.4 / 8.9 / 5.4
	Heating(Hi/Me/Lo/Ulo)	m ³ /min	12.2 / 10.3 / 7.2 / 5.4	12.8 / 11.0 / 7.8 / 5.4	13.9 / 11.8 / 8.6 / 5.4	17.3 / 14.3 / 9.8 / 6.2	17.8 / 13.7 / 10.9 / 6.2
Exterior dimensions (H×W×D)	mm	305×920×220					
Net weight	kg	13.0					
Refrigerant piping size	Liquid / Gas	Φmm 6.35(1/4") / 9.52(3/8")			6.35(1/4") / 12.7(1/2")		
Clean filter		Allergen Clear Filter ×1, Photocatalytic Washable Deodorising Filter×1					

* Colour variation available [-WFB] [-WFT]

Wall Mounted

SRK-ZR



Item	Model	SRK71ZR-WF, -W	SRK80ZR-WF, -W
Nominal cooling capacity	kW	7.1	8.0
Nominal heating capacity	kW	8.0	9.0
Sound power level	Cooling	dB(A)	57
	Heating	dB(A)	60
Sound pressure level	Cooling(Hi/Me/Lo/Ulo)	dB(A)	44 / 41 / 37 / 25
	Heating(Hi/Me/Lo/Ulo)	dB(A)	46 / 39 / 35 / 28
Air flow	Cooling(Hi/Me/Lo/Ulo)	m ³ /min	20.5 / 18.6 / 16.2 / 10.4
	Heating(Hi/Me/Lo/Ulo)	m ³ /min	25.0 / 19.8 / 17.3 / 13.3
Exterior dimensions (H×W×D)	mm	339×1197×262	
Net weight	kg	15.5	16.5
Refrigerant piping size	Liquid / Gas	Φmm 6.35 (1/4") / 15.88 (5/8")	
Clean filter		Allergen Clear Filter ×1, Photocatalytic Washable Deodorising Filter×1	

Wall Mounted

SRK-ZS



Item	Model	SRK15ZS-WF*	SRK20ZS-WF*, -W	SRK25ZS-WF*, -W	SRK35ZS-WF*, -W	SRK50ZS-WF*, -W	
Nominal cooling capacity	kW	1.5	2.0	2.5	3.5	5.0	
Nominal heating capacity	kW	2.0	3.0	3.4	4.5	5.8	
Sound power level	Cooling	dB(A)	48	48	50	54	59
	Heating	dB(A)	50	50	53	56	60
Sound pressure level	Cooling(Hi/Me/Lo/Ulo)	dB(A)	34 / 25 / 22 / 19	34 / 25 / 22 / 19	36 / 28 / 23 / 19	40 / 30 / 26 / 19	46 / 36 / 29 / 22
	Heating(Hi/Me/Lo/Ulo)	dB(A)	36 / 29 / 23 / 19	36 / 29 / 23 / 19	39 / 30 / 24 / 19	41 / 36 / 25 / 19	46 / 37 / 31 / 24
Air flow	Cooling(Hi/Me/Lo/Ulo)	m ³ /min	9.3 / 7.0 / 5.9 / 5.0	9.3 / 7.0 / 5.9 / 5.0	9.9 / 8.0 / 5.9 / 5.0	11.3 / 8.7 / 7.0 / 5.0	12.1 / 9.9 / 7.4 / 5.9
	Heating(Hi/Me/Lo/Ulo)	m ³ /min	10.0 / 8.5 / 6.5 / 5.9	10.0 / 8.5 / 6.5 / 5.9	11.3 / 8.7 / 6.7 / 5.9	12.3 / 11.0 / 7.0 / 5.6	13.9 / 11.2 / 9.1 / 7.4
Exterior dimensions (H×W×D)	mm	290×870×230					
Net weight	kg	9.5					
Refrigerant piping size	Liquid / Gas	Φmm 6.35(1/4") / 9.52(3/8")			6.35(1/4") / 12.7(1/2")		
Clean filter		Allergen Clear Filter ×1, Photocatalytic Washable Deodorising Filter ×1					

* Colour variation available [-WFB] [-WFT]

Wall Mounted

SKM-ZSP

• Compact and Light weight



Item	Model	SKM15ZSP-W	SKM20ZSP-W	SKM25ZSP-W	SKM35ZSP-W	
Nominal cooling capacity	kW	1.5	2.0	2.5	3.5	
Nominal heating capacity	kW	2.0	3.0	3.4	4.5	
Sound power level	Cooling	dB(A)	57	57	57	58
	Heating	dB(A)	56	56	56	58
Sound pressure level	Cooling(Hi/Me/Lo/Ulo)	dB(A)	42 / 35 / 22	42 / 35 / 22	43 / 36 / 23	44 / 37 / 25
	Heating(Hi/Me/Lo/Ulo)	dB(A)	41 / 36 / 26	41 / 36 / 26	41 / 36 / 27	42 / 37 / 30
Air flow	Cooling(Hi/Me/Lo/Ulo)	m ³ /min	8.5 / 7.0 / 5.0	8.5 / 7.0 / 5.0	8.5 / 7.0 / 5.0	9.0 / 7.5 / 5.0
	Heating(Hi/Me/Lo/Ulo)	m ³ /min	8.0 / 7.0 / 5.5	8.0 / 7.0 / 5.5	8.0 / 7.0 / 5.5	8.5 / 7.0 / 6.0
Exterior dimensions (H×W×D)	mm	267×783×210				
Net weight	kg	7.5				
Refrigerant piping size	Liquid / Gas	Φmm 6.35(1/4") / 9.52(3/8")				
Clean filter		—				

NOTES

*The data are measured under the following conditions:(ISO-T1, H1). Cooling: Indoor temp. of 27°CDB, 19°CWB, and outdoor temp. of 35°CDB. Heating: Indoor temp. of 20°CDB, and outdoor temp. of 7°CDB, 6°CWB.
 * Sound level the value in an anechoic chamber. During operation these values are somewhat higher due to ambient conditions.

Floor Standing

SRF-ZS/ZSX



Item	Model	SRF25ZS-W	SRF35ZS-W	SRF50ZSX-W
Nominal cooling capacity	kW	2.5	3.5	5.0
Nominal heating capacity	kW	3.4	4.5	5.8
Sound power level	Cooling	50	51	58
	Heating	51	52	58
Sound pressure level	Cooling(Hi/Me/Lo/Ulo)	38 / 32 / 29 / 25	40 / 35 / 33 / 29	46 / 38 / 33 / 28
	Heating(Hi/Me/Lo/Ulo)	39 / 35 / 33 / 29	41 / 36 / 35 / 33	46 / 41 / 38 / 32
Air flow	Cooling(Hi/Me/Lo/Ulo)	9.0 / 7.6 / 6.7 / 5.8	9.2 / 7.8 / 7.3 / 6.4	11.5 / 9.6 / 7.4 / 6.6
	Heating(Hi/Me/Lo/Ulo)	10.5 / 8.2 / 7.7 / 6.6	10.7 / 8.3 / 8.1 / 7.4	12.0 / 10.0 / 9.4 / 7.6
Exterior dimensions(H×W×D)	mm	600×860×238		
Net weight	kg	18.0	19.0	
Refrigerant piping size	Liquid / Gas	6.35(1/4") / 9.52(3/8")		6.35(1/4") / 12.7(1/2")
Clean filter		Allergen Clear Filter × 1 Photocatalytic Washable Deodorising Filter × 1		

Ceiling Concealed

SRR-ZS

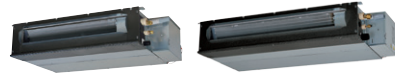

Item	Model	SRR25ZS-W	SRR35ZS-W	SRR50ZS-W	SRR60ZS-W
Nominal cooling capacity	kW	2.5	3.5	5.0	6.0
Nominal heating capacity	kW	3.4	4.5	5.8	6.8
Sound power level	Cooling	56	57	59	60
	Heating	59	60	61	63
Sound pressure level	Cooling(Hi/Me/Lo/Ulo)	37 / 33 / 30 / 24	38 / 34 / 31 / 25	41 / 37 / 34 / 29	44 / 38 / 35 / 30
	Heating(Hi/Me/Lo/Ulo)	40 / 37 / 34 / 28	42 / 38 / 35 / 29	43 / 39 / 37 / 32	45 / 41 / 38 / 33
Air flow	Cooling(Hi/Me/Lo/Ulo)	9.5 / 8.0 / 6.5 / 4.5	10.0 / 8.5 / 7.0 / 5.0	13.5 / 11.0 / 10.0 / 7.5	14.5 / 11.5 / 10.5 / 8.0
	Heating(Hi/Me/Lo/Ulo)	10.0 / 9.0 / 8.0 / 6.0	10.5 / 9.5 / 8.5 / 6.5	14.0 / 12.5 / 11.0 / 8.5	15.0 / 13.0 / 11.5 / 9.0
External static pressure	Pa	Standard : 5"(Initial static pressure with air filter : 5Pa)			
Exterior dimensions(H×W×D)	mm	200×750×500		200×950×500	
Net weight	kg	20.5		24.0	
Refrigerant piping size	Liquid / Gas	6.35(1/4") / 9.52(3/8")		6.35(1/4") / 12.7(1/2")	
Bottom air inlet kit (option)		UT-BAT1EF		UT-BAT2EF	

*1 The maximum external static pressure can be used up to 35Pa(25*35ZS), 50Pa(50*60ZS), but the airflow will be reduced.

4way Ceiling Cassette

FDTC-VH

- Draft prevention panel (Option)
- Motion sensor (Option)
- More quiet noise & Improve the aerodynamic performance



Item	Model	FDTC25VH1	FDTC35VH1	FDTC50VH	FDTC60VH
Nominal cooling capacity	kW	2.5	3.5	5.0	6.0
Nominal heating capacity	kW	3.4	4.5	5.8	6.8
Sound power level	Cooling	51	52	59	60
	Heating	52	53	59	60
Sound pressure level	Cooling(P-Hi/Hi/Me/Lo)	38 / 34 / 30 / 27	39 / 36 / 32 / 29	44 / 40 / 35 / 27	46 / 42 / 38 / 31
	Heating(P-Hi/Hi/Me/Lo)	39 / 36 / 32 / 28	41 / 38 / 34 / 30	44 / 40 / 35 / 27	46 / 42 / 38 / 31
Air flow	Cooling(P-Hi/Hi/Me/Lo)	8.5 / 7.5 / 7.0 / 6.0	9.0 / 8.0 / 7.5 / 6.5	13.0 / 11.0 / 9.0 / 7.0	14.0 / 12.0 / 10.0 / 8.0
	Heating(P-Hi/Hi/Me/Lo)	9.5 / 8.5 / 7.5 / 6.5	10.0 / 9.0 / 8.0 / 7.0	13.0 / 11.0 / 9.0 / 7.0	14.0 / 12.0 / 10.0 / 8.0
Exterior dimensions(H×W×D)	mm	Unit : 248×570×570		Panel : 10×620×620	
Net weight	kg	16.5 (Unit:14 Panel:2.5)			
Refrigerant piping size	Liquid / Gas	6.35(1/4") / 9.52(3/8")		6.35(1/4") / 12.7(1/2")	
Panel		Standard Panel : TC-PSA-5AW-E(Honeycomb), TC-PSAG-5AW-E(Grid) Draft Prevention Panel : TC-PSAE-5AW-E(Honeycomb), TC-PSAGE-5AW-E(Grid)			

Duct Connected-Low/Middle Static Pressure / Ceiling Suspended

FDUM-VH / FDE-VH



•Motion sensor (Option)



•Motion sensor (Option)

Item	Model	FDUM50VH	FDE50VH
Nominal cooling capacity	kW	5.0	5.0
Nominal heating capacity	kW	5.8	5.8
Sound power level	Cooling	60	60
	Heating	60	60
Sound pressure level	Cooling(P-Hi/Hi/Me/Lo)	37 / 32 / 29 / 26	46 / 38 / 36 / 31
	Heating(P-Hi/Hi/Me/Lo)	37 / 32 / 29 / 26	46 / 38 / 36 / 31
Air flow	Cooling(P-Hi/Hi/Me/Lo)	13.0 / 10.0 / 9.0 / 8.0	13.0 / 10.0 / 9.0 / 7.0
	Heating(P-Hi/Hi/Me/Lo)	13.0 / 10.0 / 9.0 / 8.0	13.0 / 10.0 / 9.0 / 7.0
Available external static pressure	Pa	Standard : 35 Max : 100	
Exterior dimensions (H×W×D)	mm	280×750×635	
Net weight	kg	29.0	
Refrigerant piping size	Liquid / Gas	6.35(1/4") / 12.7(1/2")	
Air filter		Filter KIT : UM-FL1EF (option)	Pocket Plastic net (Washable) × 2



MULTI-SPLIT SYSTEM

TABLE OF INDOOR UNIT COMBINATIONS

- The combinations of the indoor units is indicated by numbers. They are read as follows.
(Example) SRK15ZS-W → 15 SRK20ZS-W → 20 SRK25ZSX-W → 25
- The capacity of the indoor units is shown by rooms. If this exceeds the maximum capacity of the outdoor unit, the demand capacity will be proportionally distributed.
- If units are to be combined, use the table below to make the proper selection.

SCM30ZS-W Table of Indoor unit combination only with SRK-ZS, SKM-ZSP type

Indoor unit combination		Heating capacity (kW)					Power consumption(W)			Standard current(A)			
		Room heating capacity		Total capacity			Min.	Standard	Max.	220V	230V	240V	
		A	B	Min.	Standard	Max.							
Heating operation	1*1 room	15	2.0	-	1.0	2.0	3.2	250	510	940	2.4	2.3	2.2
		20	3.0	-	1.0	3.0	4.3	250	780	1260	3.7	3.6	3.4
		25	3.4	-	1.0	3.4	4.5	250	910	1310	4.4	4.2	4.0
	2*2 room	15 + 15	2.00	2.00	1.1	4.0	5.7	250	740	1490	3.5	3.4	3.2
		15 + 20	1.71	2.29	1.1	4.0	5.7	250	740	1490	3.5	3.4	3.2
		15 + 25	1.50	2.50	1.1	4.0	5.7	250	740	1490	3.5	3.4	3.2
2*2 room	20 + 20	2.00	2.00	1.1	4.0	5.7	250	740	1490	3.5	3.4	3.2	
	20 + 25	1.78	2.22	1.1	4.0	5.7	250	740	1490	3.5	3.4	3.2	
	25 + 25	2.00	2.00	1.1	4.0	5.7	250	740	1490	3.5	3.4	3.2	

The values are for 1 indoor unit (*1) and 2 indoor units (*2) operation.
The same hereinafter.

Indoor unit combination		Cooling capacity (kW)					Power consumption(W)			Standard current(A)			
		Room cooling capacity		Total capacity			Min.	Standard	Max.	220V	230V	240V	
		A	B	Min.	Standard	Max.							
Cooling operation	1 room	15	1.50	-	1.4	1.5	2.2	320	350	710	1.8	1.7	1.6
		20	2.00	-	1.4	2.0	2.9	320	510	930	2.6	2.5	2.4
		25	2.50	-	1.4	2.5	3.1	320	710	990	3.6	3.5	3.3
	2 room	15 + 15	1.50	1.50	1.6	3.0	4.4	320	520	1280	2.7	2.5	2.4
		15 + 20	1.29	1.71	1.6	3.0	4.9	320	520	1520	2.7	2.5	2.4
		15 + 25	1.13	1.88	1.6	3.0	5.0	320	520	1600	2.7	2.5	2.4
		20 + 20	1.50	1.50	1.6	3.0	5.0	320	520	1600	2.7	2.5	2.4
		20 + 25	1.33	1.67	1.6	3.0	5.0	320	520	1600	2.7	2.5	2.4
		25 + 25	1.50	1.50	1.6	3.0	5.0	320	520	1600	2.7	2.5	2.4

SCM40ZS-W Table of Indoor unit combination only with SRK-ZSX type

Indoor unit combination		Heating capacity (kW)					Power consumption(W)			Standard current(A)			
		Room heating capacity		Total capacity			Min.	Standard	Max.	220V	230V	240V	
		A	B	Min.	Standard	Max.							
Heating operation	1*1 room	20	3.00	-	1.0	3.0	4.5	250	680	1140	3.2	3.1	3.0
		25	3.40	-	1.0	3.4	4.9	250	790	1270	3.7	3.5	3.4
		35	4.50	-	1.0	4.5	5.4	250	1140	1470	5.3	5.1	4.8
	2*2 room	20 + 20	2.25	2.25	1.2	4.5	6.3	250	830	1480	3.8	3.7	3.5
		20 + 25	2.00	2.50	1.2	4.5	6.3	250	830	1480	3.8	3.7	3.5
		20 + 35	1.64	2.86	1.2	4.5	6.3	250	830	1480	3.8	3.7	3.5
2*2 room	25 + 25	2.25	2.25	1.2	4.5	6.3	250	830	1480	3.8	3.7	3.5	
	25 + 35	1.88	2.63	1.2	4.5	6.3	250	830	1480	3.8	3.7	3.5	

Indoor unit combination		Cooling capacity (kW)					Power consumption(W)			Standard current(A)			
		Room cooling capacity		Total capacity			Min.	Standard	Max.	220V	230V	240V	
		A	B	Min.	Standard	Max.							
Cooling operation	1 room	20	2.00	-	1.5	2.0	3.4	340	430	930	2.2	2.1	2.0
		25	2.50	-	1.5	2.5	3.8	340	600	1110	3.0	2.9	2.8
		35	3.50	-	1.5	3.5	4.5	340	1000	1470	4.7	4.5	4.3
	2 room	20 + 20	2.00	2.00	1.7	4.0	5.9	340	800	2100	3.7	3.5	3.4
		20 + 25	1.78	2.22	1.7	4.0	5.9	340	800	2100	3.7	3.5	3.4
		20 + 35	1.45	2.55	1.7	4.0	5.9	340	800	2100	3.7	3.5	3.4
		25 + 25	2.00	2.00	1.7	4.0	5.9	340	800	2100	3.7	3.5	3.4
		25 + 35	1.67	2.33	1.7	4.0	5.9	340	800	2100	3.7	3.5	3.4

COMBINATIONS

SCM40ZS-W Table of Indoor unit combination with other indoor unit

Indoor unit combination		Heating capacity (kW)					Power consumption(W)			Standard current(A)			
		Room heating capacity		Total capacity			Min.	Standard	Max.	220V	230V	240V	
		A	B	Min.	Standard	Max.							
Heating operation	1 room	20	3.00	-	1.0	3.0	3.5	250	780	940	3.8	3.6	3.5
		25	3.40	-	1.0	3.4	4.0	250	910	1120	4.4	4.2	4.1
		35	4.50	-	1.0	4.5	4.8	250	1310	1350	6.4	6.1	5.9
	2 room	20 + 20	2.25	2.25	1.2	4.5	5.5	250	990	1270	4.8	4.6	4.4
		20 + 25	2.00	2.50	1.2	4.5	6.3	250	990	1630	4.7	4.5	4.3
		20 + 35	1.64	2.86	1.2	4.5	6.3	250	990	1630	4.6	4.4	4.2
25 + 25		2.25	2.25	1.2	4.5	6.3	250	990	1630	4.6	4.4	4.2	
	25 + 35	1.88	2.63	1.2	4.5	6.3	250	990	1630	4.6	4.4	4.2	

Indoor unit combination		Cooling capacity (kW)					Power consumption(W)			Standard current(A)			
		Room cooling capacity		Total capacity			Min.	Standard	Max.	220V	230V	240V	
		A	B	Min.	Standard	Max.							
Cooling operation	1 room	20	2.00	-	1.5	2.0	3.1	340	510	990	2.5	2.4	2.3
		25	2.50	-	1.5	2.5	3.4	340	710	1120	3.4	3.2	3.1
		35	3.50	-	1.5	3.5	4.1	340	1190	1570	5.5	5.3	5.0
	2 room	20 + 20	2.00	2.00	1.7	4.0	5.4	340	1000	1920	4.6	4.4	4.2
		20 + 25	1.78	2.22	1.7	4.0	5.6	340	1000	2100	4.6	4.4	4.2
		20 + 35	1.45	2.55	1.7	4.0	5.6	340	1000	2100	4.6	4.4	4.2
25 + 25		2.00	2.00	1.7	4.0	5.6	340	1000	2100	4.6	4.4	4.2	
	25 + 35	1.67	2.33	1.7	4.0	5.6	340	1000	2100	4.6	4.4	4.2	

SCM45ZS-W Table of Indoor unit combination only with SRK-ZSX type

Indoor unit combination		Heating capacity (kW)					Power consumption(W)			Standard current(A)			
		Room heating capacity		Total capacity			Min.	Standard	Max.	220V	230V	240V	
		A	B	Min.	Standard	Max.							
Heating operation	1 room	20	3.00	-	1.0	3.0	4.5	250	680	1140	3.2	3.1	3.0
		25	3.40	-	1.0	3.4	4.9	250	790	1270	3.7	3.5	3.4
		35	4.50	-	1.0	4.5	5.4	250	1140	1470	5.3	5.1	4.8
	2 room	20 + 20	2.25	2.25	1.2	4.5	6.5	250	830	1480	3.8	3.7	3.5
		20 + 25	2.36	2.94	1.2	5.3	6.5	250	1060	1480	4.9	4.7	4.5
		20 + 35	1.93	3.37	1.2	5.3	6.5	250	1060	1480	4.9	4.7	4.5
25 + 25		2.65	2.65	1.2	5.3	6.5	250	1060	1480	4.9	4.7	4.5	
	25 + 35	2.21	3.09	1.2	5.3	6.5	250	1060	1480	4.9	4.7	4.5	
	35 + 35	2.65	2.65	1.2	5.3	6.5	250	1060	1480	4.9	4.7	4.5	

Indoor unit combination		Cooling capacity (kW)					Power consumption(W)			Standard current(A)			
		Room cooling capacity		Total capacity			Min.	Standard	Max.	220V	230V	240V	
		A	B	Min.	Standard	Max.							
Cooling operation	1 room	20	2.00	-	1.5	2.0	3.4	340	430	930	2.2	2.1	2.0
		25	2.50	-	1.5	2.5	3.8	340	600	1110	3.0	2.9	2.8
		35	3.50	-	1.5	3.5	4.5	340	1000	1470	4.7	4.5	4.3
	2 room	20 + 20	2.00	2.00	1.7	4.0	6.2	340	860	2100	4.0	3.8	3.7
		20 + 25	2.00	2.50	1.7	4.5	6.4	340	960	2300	4.5	4.3	4.1
		20 + 35	1.64	2.86	1.7	4.5	6.4	340	960	2300	4.5	4.3	4.1
25 + 25		2.25	2.25	1.7	4.5	6.4	340	960	2300	4.5	4.3	4.1	
	25 + 35	1.88	2.63	1.7	4.5	6.4	340	960	2300	4.5	4.3	4.1	
	35 + 35	2.25	2.25	1.7	4.5	6.4	340	960	2300	4.5	4.3	4.1	

SCM45ZS-W Table of Indoor unit combination with other indoor unit

Indoor unit combination		Heating capacity (kW)					Power consumption(W)			Standard current(A)			
		Room heating capacity		Total capacity			Min.	Standard	Max.	220V	230V	240V	
		A	B	Min.	Standard	Max.							
Heating operation	1 room	20	3.00	-	1.0	3.0	3.5	250	780	940	3.7	3.5	3.4
		25	3.40	-	1.0	3.4	4.0	250	910	1120	4.3	4.1	3.9
		35	4.50	-	1.0	4.5	4.8	250	1310	1350	6.1	5.8	5.6
	2 room	20 + 20	2.25	2.25	1.2	4.5	5.5	250	990	1270	4.6	4.4	4.2
		20 + 25	2.36	2.94	1.2	5.3	6.5	250	1280	1630	5.9	5.7	5.4
		20 + 35	1.93	3.37	1.2	5.3	6.5	250	1280	1630	5.9	5.7	5.4
25 + 25		2.65	2.65	1.2	5.3	6.5	250	1280	1630	5.9	5.7	5.4	
	25 + 35	2.21	3.09	1.2	5.3	6.5	250	1280	1630	5.9	5.7	5.4	
	35 + 35	2.65	2.65	1.2	5.3	6.5	250	1280	1630	5.9	5.7	5.4	

Indoor unit combination		Cooling capacity (kW)					Power consumption(W)			Standard current(A)			
		Room cooling capacity		Total capacity			Min.	Standard	Max.	220V	230V	240V	
		A	B	Min.	Standard	Max.							
Cooling operation	1 room	20	2.00	-	1.5	2.0	3.1	340	510	990	2.5	2.4	2.3
		25	2.50	-	1.5	2.5	3.4	340	710	1120	3.4	3.2	3.1
		35	3.50	-	1.5	3.5	4.1	340	1190	1570	5.5	5.3	5.0
	2 room	20 + 20	2.00	2.00	1.7	4.0	5.4	340	1050	1920	4.8	4.6	4.4
		20 + 25	2.00	2.50	1.7	4.5	5.6	340	1200	2300	5.5	5.3	5.1
		20 + 35	1.64	2.86	1.7	4.5	5.6	340	1200	2300	5.5	5.3	5.1
25 + 25		2.25	2.25	1.7	4.5	5.6	340	1200	2300	5.5	5.3	5.1	
	25 + 35	1.88	2.63	1.7	4.5	5.6	340	1200	2300	5.5	5.3	5.1	
	35 + 35	2.25	2.25	1.7	4.5	5.6	340	1200	2300	5.5	5.3	5.1	



MULTI-SPLIT SYSTEM

SCM41ZS-W Table of Indoor unit combination only with SRK-ZS, SKM-ZSP type

Indoor unit combination		Heating capacity (kW)						Power consumption(W)			Standard current(A)			
		Room heating capacity			Total capacity			Min.	Standard	Max.	220V	230V	240V	
		A	B	C	Min.	Standard	Max.							
Heating operation	1 room	15	2.00	-	-	1.0	2.0	3.2	250	550	990	2.6	2.5	2.4
		20	3.00	-	-	1.0	3.0	4.3	250	870	1330	4.1	3.9	3.8
		25	3.40	-	-	1.0	3.4	4.5	250	1010	1390	4.8	4.6	4.4
		35	4.50	-	-	1.0	4.5	5.0	250	1390	1550	6.6	6.3	6.0
	2 room	15 + 15	1.70	1.70	-	1.1	3.4	6.6	250	700	1580	3.3	3.2	3.0
		15 + 20	1.67	2.23	-	1.1	3.9	6.6	250	840	1580	4.0	3.8	3.6
		15 + 25	1.69	2.81	-	1.1	4.5	6.6	250	1020	1580	4.8	4.6	4.4
		15 + 35	1.35	3.15	-	1.1	4.5	6.6	250	1020	1580	4.8	4.6	4.4
		20 + 20	2.25	2.25	-	1.1	4.5	6.6	250	1020	1580	4.8	4.6	4.4
		20 + 25	2.00	2.50	-	1.1	4.5	6.6	250	1020	1580	4.8	4.6	4.4
		20 + 35	1.64	2.86	-	1.1	4.5	6.6	250	1020	1580	4.8	4.6	4.4
		25 + 25	2.25	2.25	-	1.1	4.5	6.6	250	1020	1580	4.8	4.6	4.4
		25 + 35	1.88	2.63	-	1.1	4.5	6.6	250	1020	1580	4.8	4.6	4.4
		35 + 35	2.25	2.25	-	1.1	4.5	6.6	250	1020	1580	4.8	4.6	4.4
	3 room	15 + 15 + 15	1.50	1.50	1.50	1.2	4.5	6.9	250	810	1580	3.8	3.7	3.5
		15 + 15 + 20	1.35	1.35	1.80	1.2	4.5	6.9	250	810	1580	3.8	3.7	3.5
		15 + 15 + 25	1.23	1.23	2.05	1.2	4.5	6.9	250	810	1580	3.8	3.7	3.5
		15 + 15 + 35	1.04	1.04	2.42	1.2	4.5	6.9	250	810	1580	3.8	3.7	3.5
		15 + 20 + 20	1.23	1.64	1.64	1.2	4.5	6.9	250	810	1580	3.8	3.7	3.5
		15 + 20 + 25	1.13	1.50	1.88	1.2	4.5	6.9	250	810	1580	3.8	3.7	3.5
15 + 20 + 35		0.96	1.29	2.25	1.2	4.5	6.9	250	810	1580	3.8	3.7	3.5	
15 + 25 + 25		1.04	1.73	1.73	1.2	4.5	6.9	250	810	1580	3.8	3.7	3.5	
20 + 20 + 20		1.50	1.50	1.50	1.2	4.5	6.9	250	810	1580	3.8	3.7	3.5	
20 + 20 + 25		1.38	1.38	1.73	1.2	4.5	6.9	250	810	1580	3.8	3.7	3.5	
20 + 25 + 25	1.29	1.61	1.61	1.2	4.5	6.9	250	810	1580	3.8	3.7	3.5		

Indoor unit combination		Cooling capacity (kW)						Power consumption(W)			Standard current(A)			
		Room cooling capacity			Total capacity			Min.	Standard	Max.	220V	230V	240V	
		A	B	C	Min.	Standard	Max.							
Cooling operation	1 room	15	1.50	-	-	1.4	1.5	2.2	320	360	740	1.7	1.6	1.6
		20	2.00	-	-	1.4	2.0	2.9	320	530	970	2.5	2.4	2.3
		25	2.50	-	-	1.4	2.5	3.1	320	730	1040	3.5	3.3	3.2
		35	3.50	-	-	1.4	3.5	4.0	320	1120	1330	5.4	5.1	4.9
	2 room	15 + 15	1.50	1.50	-	1.5	3.0	4.9	320	550	1400	2.6	2.5	2.4
		15 + 20	1.50	2.00	-	1.5	3.5	5.5	320	700	1600	3.3	3.2	3.1
		15 + 25	1.50	2.50	-	1.5	4.0	5.7	320	910	1650	4.4	4.2	4.0
		15 + 35	1.20	2.80	-	1.5	4.0	5.7	320	910	1650	4.4	4.2	4.0
		20 + 20	2.00	2.00	-	1.5	4.0	5.7	320	910	1650	4.4	4.2	4.0
		20 + 25	1.78	2.22	-	1.5	4.0	5.7	320	910	1650	4.4	4.2	4.0
		20 + 35	1.45	2.55	-	1.5	4.0	5.7	320	910	1650	4.4	4.2	4.0
		25 + 25	2.00	2.00	-	1.5	4.0	5.7	320	910	1650	4.4	4.2	4.0
		25 + 35	1.67	2.33	-	1.5	4.0	5.7	320	910	1650	4.4	4.2	4.0
		35 + 35	2.00	2.00	-	1.5	4.0	5.7	320	910	1650	4.4	4.2	4.0
	3 room	15 + 15 + 15	1.33	1.33	1.33	1.6	4.0	6.3	320	720	1650	3.4	3.3	3.2
		15 + 15 + 20	1.20	1.20	1.60	1.6	4.0	6.3	320	720	1650	3.4	3.3	3.2
		15 + 15 + 25	1.09	1.09	1.82	1.6	4.0	6.3	320	720	1650	3.4	3.3	3.2
		15 + 15 + 35	0.92	0.92	2.15	1.6	4.0	6.3	320	720	1650	3.4	3.3	3.2
		15 + 20 + 20	1.09	1.45	1.45	1.6	4.0	6.3	320	720	1650	3.4	3.3	3.2
		15 + 20 + 25	1.00	1.33	1.67	1.6	4.0	6.3	320	720	1650	3.4	3.3	3.2
15 + 20 + 35		0.86	1.14	2.00	1.6	4.0	6.3	320	720	1650	3.4	3.3	3.2	
15 + 25 + 25		0.92	1.54	1.54	1.6	4.0	6.3	320	720	1650	3.4	3.3	3.2	
20 + 20 + 20		1.33	1.33	1.33	1.6	4.0	6.3	320	720	1650	3.4	3.3	3.2	
20 + 20 + 25		1.23	1.23	1.54	1.6	4.0	6.3	320	720	1650	3.4	3.3	3.2	
20 + 25 + 25	1.14	1.43	1.43	1.6	4.0	6.3	320	720	1650	3.4	3.3	3.2		

SCM50ZS-W Table of Indoor unit combination only with SRK-ZSX type

Indoor unit combination		Heating capacity (kW)						Power consumption(W)			Standard current(A)			
		Room heating capacity			Total capacity			Min.	Standard	Max.	220V	230V	240V	
		A	B	C	Min.	Standard	Max.							
Heating operation	1 room	20	3.00	-	-	1.0	3.0	3.7	320	780	1100	3.6	3.5	3.3
		25	3.40	-	-	1.0	3.4	4.2	320	950	1240	4.4	4.2	4.0
		35	4.50	-	-	1.0	4.5	5.0	320	1270	1490	5.9	5.6	5.4
		50	5.80	-	-	1.0	5.8	6.5	320	1710	2310	7.9	7.6	7.3
	2 room	20 + 20	2.70	2.70	-	1.2	5.4	7.3	290	1050	2500	4.9	4.7	4.5
		20 + 25	2.62	3.28	-	1.2	5.9	7.3	290	1180	2500	5.5	5.2	5.0
		20 + 35	2.18	3.82	-	1.2	6.0	7.3	290	1200	2500	5.6	5.3	5.1
		20 + 50	1.71	4.29	-	1.2	6.0	7.3	290	1200	2500	5.6	5.3	5.1
		25 + 25	3.00	3.00	-	1.2	6.0	7.3	290	1200	2500	5.6	5.3	5.1
		25 + 35	2.50	3.50	-	1.2	6.0	7.3	290	1200	2500	5.6	5.3	5.1
		25 + 50	2.00	4.00	-	1.2	6.0	7.3	290	1200	2500	5.6	5.3	5.1
		35 + 35	3.00	3.00	-	1.2	6.0	7.3	290	1200	2500	5.6	5.3	5.1
		35 + 50	2.47	3.53	-	1.2	6.0	7.3	290	1200	2500	5.6	5.3	5.1
		50 + 50	2.00	2.00	2.00	1.4	6.0	7.5	270	1160	2500	5.4	5.1	4.9
	3 room	20 + 20 + 20	1.85	1.85	2.31	1.4	6.0	7.5	270	1160	2500	5.4	5.1	4.9
		20 + 20 + 35	1.60	1.60	2.80	1.4	6.0	7.5	270	1160	2500	5.4	5.1	4.9
		20 + 25 + 25	1.71	2.14	2.14	1.4	6.0	7.5	270	1160	2500	5.4	5.1	4.9
		20 + 25 + 35	1.50	1.88	2.63	1.4	6.0	7.5	270	1160	2500	5.4	5.1	4.9
		25 + 25 + 25	2.00	2.00	2.00	1.4	6.0	7.5	270	1160	2500	5.4	5.1	4.9
		25 + 25 + 35	1.76	1.76	2.47	1.4	6.0	7.5	270	1160	2500	5.4	5.1	4.9

COMBINATIONS

Indoor unit combination		Cooling capacity (kW)						Power consumption(W)			Standard current(A)			
		Room cooling capacity			Total capacity			Min.	Standard	Max.	220V	230V	240V	
		A	B	C	Min.	Standard	Max.							
Cooling operation	1 room	20	2.00	-	-	1.7	2.0	2.8	430	500	950	2.4	2.3	2.2
		25	2.50	-	-	1.7	2.5	3.4	430	680	1070	3.2	3.1	3.0
		35	3.50	-	-	1.7	3.5	3.9	430	1010	1230	4.7	4.5	4.3
		50	5.00	-	-	1.7	5.0	5.5	430	1530	2000	7.0	6.7	6.4
	2 room	20 + 20	2.00	2.00	-	1.8	4.0	5.7	390	750	1750	3.5	3.3	3.2
		20 + 25	2.00	2.50	-	1.8	4.5	5.9	390	990	1910	4.6	4.4	4.2
		20 + 35	1.82	3.18	-	1.8	5.0	6.5	390	1110	2150	5.1	4.9	4.7
		20 + 50	1.43	3.57	-	1.8	5.0	6.5	390	1110	2150	5.1	4.9	4.7
		25 + 25	2.50	2.50	-	1.8	5.0	6.5	390	1110	2150	5.1	4.9	4.7
		25 + 35	2.08	2.92	-	1.8	5.0	6.5	390	1110	2150	5.1	4.9	4.7
		25 + 50	1.67	3.33	-	1.8	5.0	6.5	390	1110	2150	5.1	4.9	4.7
		35 + 35	2.50	2.50	-	1.8	5.0	6.5	390	1110	2150	5.1	4.9	4.7
	35 + 50	2.06	2.94	-	1.8	5.0	6.5	390	1110	2150	5.1	4.9	4.7	
	3 room	20 + 20 + 20	1.67	1.67	1.67	2.1	5.0	7.1	350	1020	2150	4.7	4.5	4.3
		20 + 20 + 25	1.54	1.54	1.92	2.1	5.0	7.1	350	1020	2150	4.7	4.5	4.3
20 + 20 + 35		1.33	1.33	2.33	2.1	5.0	7.1	350	1020	2150	4.7	4.5	4.3	
20 + 25 + 25		1.43	1.79	1.79	2.1	5.0	7.1	350	1020	2150	4.7	4.5	4.3	
20 + 25 + 35		1.25	1.56	2.19	2.1	5.0	7.1	350	1020	2150	4.7	4.5	4.3	
25 + 25 + 25		1.67	1.67	1.67	2.1	5.0	7.1	350	1020	2150	4.7	4.5	4.3	
25 + 25 + 35	1.47	1.47	2.06	2.1	5.0	7.1	350	1020	2150	4.7	4.5	4.3		

SCM50ZS-W Table of Indoor unit combination with other indoor unit

Indoor unit combination		Heating capacity (kW)						Power consumption(W)			Standard current(A)			
		Room heating capacity			Total capacity			Min.	Standard	Max.	220V	230V	240V	
		A	B	C	Min.	Standard	Max.							
Heating operation	1 room	20	3.00	-	-	1.0	3.0	3.5	320	970	1100	4.5	4.3	4.1
		25	3.40	-	-	1.0	3.4	4.0	320	1140	1240	5.3	5.1	4.8
		35	4.50	-	-	1.0	4.5	4.8	320	1480	1490	6.9	6.6	6.3
		50	5.80	-	-	1.0	5.8	6.1	320	1780	2310	8.3	7.9	7.6
	2 room	20 + 20	2.70	2.70	-	1.2	5.4	7.0	290	1350	2500	6.3	6.0	5.7
		20 + 25	2.62	3.28	-	1.2	5.9	7.0	290	1480	2500	6.9	6.6	6.3
		20 + 35	2.18	3.82	-	1.2	6.0	7.0	290	1500	2500	7.0	6.7	6.4
		20 + 50	1.71	4.29	-	1.2	6.0	7.0	290	1500	2500	7.0	6.7	6.4
		25 + 25	3.00	3.00	-	1.2	6.0	7.0	290	1500	2500	7.0	6.7	6.4
		25 + 35	2.50	3.50	-	1.2	6.0	7.0	290	1500	2500	7.0	6.7	6.4
		25 + 50	2.00	4.00	-	1.2	6.0	7.0	290	1500	2500	7.0	6.7	6.4
		35 + 35	3.00	3.00	-	1.2	6.0	7.0	290	1500	2500	7.0	6.7	6.4
	35 + 50	2.47	3.53	-	1.2	6.0	7.0	290	1500	2500	7.0	6.7	6.4	
	3 room	20 + 20 + 20	2.00	2.00	2.00	1.4	6.0	7.3	270	1300	2500	6.0	5.8	5.5
		20 + 20 + 25	1.85	1.85	2.31	1.4	6.0	7.3	270	1300	2500	6.0	5.8	5.5
20 + 20 + 35		1.60	1.60	2.80	1.4	6.0	7.3	270	1300	2500	6.0	5.8	5.5	
20 + 25 + 25		1.71	2.14	2.14	1.4	6.0	7.3	270	1300	2500	6.0	5.8	5.5	
20 + 25 + 35		1.50	1.88	2.63	1.4	6.0	7.3	270	1300	2500	6.0	5.8	5.5	
25 + 25 + 25		2.00	2.00	2.00	1.4	6.0	7.3	270	1300	2500	6.0	5.8	5.5	
25 + 25 + 35	1.76	1.76	2.47	1.4	6.0	7.3	270	1300	2500	6.0	5.8	5.5		

Indoor unit combination		Cooling capacity (kW)						Power consumption(W)			Standard current(A)			
		Room cooling capacity			Total capacity			Min.	Standard	Max.	220V	230V	240V	
		A	B	C	Min.	Standard	Max.							
Cooling operation	1 room	20	2.00	-	-	1.7	2.0	2.7	430	530	900	2.5	2.4	2.3
		25	2.50	-	-	1.7	2.5	3.2	430	730	1070	3.4	3.3	3.1
		35	3.50	-	-	1.7	3.5	3.7	430	1120	1230	5.2	4.9	4.7
		50	5.00	-	-	1.7	5.0	5.3	430	1710	2000	7.9	7.5	7.2
	2 room	20 + 20	2.00	2.00	-	1.8	4.0	5.6	390	950	1800	4.4	4.2	4.0
		20 + 25	2.00	2.50	-	1.8	4.5	5.8	390	1110	1980	5.1	4.9	4.7
		20 + 35	1.82	3.18	-	1.8	5.0	6.3	390	1350	2150	6.2	5.9	5.7
		20 + 50	1.43	3.57	-	1.8	5.0	6.3	390	1350	2150	6.2	5.9	5.7
		25 + 25	2.50	2.50	-	1.8	5.0	6.3	390	1350	2150	6.2	5.9	5.7
		25 + 35	2.08	2.92	-	1.8	5.0	6.3	390	1350	2150	6.2	5.9	5.7
		25 + 50	1.67	3.33	-	1.8	5.0	6.3	390	1350	2150	6.2	5.9	5.7
		35 + 35	2.50	2.50	-	1.8	5.0	6.3	390	1350	2150	6.2	5.9	5.7
	35 + 50	2.06	2.94	-	1.8	5.0	6.3	390	1350	2150	6.2	5.9	5.7	
	3 room	20 + 20 + 20	1.67	1.67	1.67	2.1	5.0	6.9	350	1120	2150	5.1	4.9	4.7
		20 + 20 + 25	1.54	1.54	1.92	2.1	5.0	6.9	350	1120	2150	5.1	4.9	4.7
20 + 20 + 35		1.33	1.33	2.33	2.1	5.0	6.9	350	1120	2150	5.1	4.9	4.7	
20 + 25 + 25		1.43	1.79	1.79	2.1	5.0	6.9	350	1120	2150	5.1	4.9	4.7	
20 + 25 + 35		1.25	1.56	2.19	2.1	5.0	6.9	350	1120	2150	5.1	4.9	4.7	
25 + 25 + 25		1.67	1.67	1.67	2.1	5.0	6.9	350	1120	2150	5.1	4.9	4.7	
25 + 25 + 35	1.47	1.47	2.06	2.1	5.0	6.9	350	1120	2150	5.1	4.9	4.7		



MULTI-SPLIT SYSTEM

SCM60ZS-W Table of Indoor unit combination only with SRK-ZSX type

Indoor unit combination		Heating capacity (kW)						Power consumption(W)			Standard current(A)			
		Room heating capacity			Total capacity			Min.	Standard	Max.	220V	230V	240V	
		A	B	C	Min.	Standard	Max.							
Heating operation	1 room	20	3.00	-	-	1.0	3.0	3.7	320	780	1100	3.6	3.5	3.3
		25	3.40	-	-	1.0	3.4	4.2	320	950	1240	4.4	4.2	4.0
		35	4.50	-	-	1.0	4.5	5.0	320	1270	1490	5.9	5.6	5.4
		50	5.80	-	-	1.0	5.8	6.5	320	1710	2310	7.9	7.6	7.3
		60	6.80	-	-	1.0	6.8	7.3	320	2040	2660	9.5	9.1	8.7
	2 room	20 + 20	2.70	2.70	-	1.2	5.4	7.3	290	1050	2100	4.9	4.7	4.5
		20 + 25	2.62	3.28	-	1.2	5.9	7.5	290	1180	2550	5.5	5.2	5.0
		20 + 35	2.40	4.20	-	1.2	6.6	7.6	290	1360	2800	6.3	6.0	5.8
		20 + 50	1.94	4.86	-	1.2	6.8	7.6	290	1440	2800	6.7	6.4	6.1
		20 + 60	1.70	5.10	-	1.2	6.8	7.6	290	1440	2800	6.7	6.4	6.1
		25 + 25	3.20	3.20	-	1.2	6.4	7.6	290	1310	2800	6.1	5.8	5.6
		25 + 35	2.83	3.97	-	1.2	6.8	7.6	290	1440	2800	6.7	6.4	6.1
		25 + 50	2.27	4.53	-	1.2	6.8	7.6	290	1440	2800	6.7	6.4	6.1
		25 + 60	2.00	4.80	-	1.2	6.8	7.6	290	1440	2800	6.7	6.4	6.1
		35 + 35	3.40	3.40	-	1.2	6.8	7.6	290	1440	2800	6.7	6.4	6.1
		35 + 50	2.80	4.00	-	1.2	6.8	7.6	290	1440	2800	6.7	6.4	6.1
		35 + 60	2.51	4.29	-	1.2	6.8	7.6	290	1440	2800	6.7	6.4	6.1
		50 + 50	3.40	3.40	-	1.2	6.8	7.6	290	1440	2800	6.7	6.4	6.1
		50 + 60	3.09	3.71	-	1.2	6.8	7.6	290	1440	2800	6.7	6.4	6.1
		3 room	20 + 20 + 20	2.27	2.27	2.27	1.4	6.8	7.8	270	1400	2800	6.5	6.2
	20 + 20 + 25		2.09	2.09	2.62	1.4	6.8	7.8	270	1400	2800	6.5	6.2	6.0
	20 + 20 + 35		1.81	1.81	3.17	1.4	6.8	7.8	270	1400	2800	6.5	6.2	6.0
	20 + 20 + 50		1.51	1.51	3.78	1.4	6.8	7.8	270	1400	2800	6.5	6.2	6.0
	20 + 20 + 60		1.36	1.36	4.08	1.4	6.8	7.8	270	1400	2800	6.5	6.2	6.0
	20 + 25 + 25		1.94	2.43	2.43	1.4	6.8	7.8	270	1400	2800	6.5	6.2	6.0
	20 + 25 + 35		1.70	2.13	2.98	1.4	6.8	7.8	270	1400	2800	6.5	6.2	6.0
	20 + 25 + 50		1.43	1.79	3.58	1.4	6.8	7.8	270	1400	2800	6.5	6.2	6.0
	20 + 25 + 60		1.30	1.62	3.89	1.4	6.8	7.8	270	1400	2800	6.5	6.2	6.0
	20 + 35 + 35		1.51	2.64	2.64	1.4	6.8	7.8	270	1400	2800	6.5	6.2	6.0
	20 + 35 + 50		1.30	2.27	3.24	1.4	6.8	7.8	270	1400	2800	6.5	6.2	6.0
25 + 25 + 25	2.27		2.27	2.27	1.4	6.8	7.8	270	1400	2800	6.5	6.2	6.0	
25 + 25 + 35	2.00		2.00	2.80	1.4	6.8	7.8	270	1400	2800	6.5	6.2	6.0	
25 + 25 + 50	1.70		1.70	3.40	1.4	6.8	7.8	270	1400	2800	6.5	6.2	6.0	
25 + 25 + 60	1.55		1.55	3.71	1.4	6.8	7.8	270	1400	2800	6.5	6.2	6.0	
25 + 35 + 35	1.79	2.51	2.51	1.4	6.8	7.8	270	1400	2800	6.5	6.2	6.0		
25 + 35 + 50	1.55	2.16	3.09	1.4	6.8	7.8	270	1400	2800	6.5	6.2	6.0		
35 + 35 + 35	2.27	2.27	2.27	1.4	6.8	7.8	270	1400	2800	6.5	6.2	6.0		

Indoor unit combination		Cooling capacity (kW)						Power consumption(W)			Standard current(A)			
		Room cooling capacity			Total capacity			Min.	Standard	Max.	220V	230V	240V	
		A	B	C	Min.	Standard	Max.							
Cooling operation	1 room	20	2.00	-	-	1.7	2.0	2.8	430	500	950	2.4	2.3	2.2
		25	2.50	-	-	1.7	2.5	3.4	430	680	1080	3.2	3.1	3.0
		35	3.50	-	-	1.7	3.5	3.9	430	1010	1240	4.7	4.5	4.3
		50	5.00	-	-	1.7	5.0	6.1	430	1530	2100	7.0	6.7	6.4
		60	6.00	-	-	1.7	6.0	6.3	430	1880	2280	8.6	8.3	7.9
	2 room	20 + 20	2.00	2.00	-	1.8	4.0	5.7	390	750	1750	3.5	3.3	3.2
		20 + 25	2.00	2.50	-	1.8	4.5	5.9	390	990	1910	4.6	4.4	4.2
		20 + 35	2.00	3.50	-	1.8	5.5	6.7	390	1320	2200	6.1	5.8	5.6
		20 + 50	1.71	4.29	-	1.8	6.0	6.9	390	1560	2280	7.2	6.9	6.6
		20 + 60	1.50	4.50	-	1.8	6.0	6.9	390	1560	2280	7.2	6.9	6.6
		25 + 25	2.50	2.50	-	1.8	5.0	6.5	390	1110	2150	5.1	4.9	4.7
		25 + 35	2.50	3.50	-	1.8	6.0	6.9	390	1560	2280	7.2	6.9	6.6
		25 + 50	2.00	4.00	-	1.8	6.0	6.9	390	1560	2280	7.2	6.9	6.6
		25 + 60	1.76	4.24	-	1.8	6.0	6.9	390	1560	2280	7.2	6.9	6.6
		35 + 35	3.00	3.00	-	1.8	6.0	6.9	390	1560	2280	7.2	6.9	6.6
		35 + 50	2.47	3.53	-	1.8	6.0	6.9	390	1560	2280	7.2	6.9	6.6
		35 + 60	2.21	3.79	-	1.8	6.0	6.9	390	1560	2280	7.2	6.9	6.6
		50 + 50	3.00	3.00	-	1.8	6.0	6.9	390	1560	2280	7.2	6.9	6.6
		50 + 60	2.73	3.27	-	1.8	6.0	6.9	390	1560	2280	7.2	6.9	6.6
		3 room	20 + 20 + 20	2.00	2.00	2.00	2.1	6.0	7.5	350	1320	2280	6.1	5.8
	20 + 20 + 25		1.85	1.85	2.31	2.1	6.0	7.5	350	1320	2280	6.1	5.8	5.6
	20 + 20 + 35		1.60	1.60	2.80	2.1	6.0	7.5	350	1320	2280	6.1	5.8	5.6
	20 + 20 + 50		1.33	1.33	3.33	2.1	6.0	7.5	350	1320	2280	6.1	5.8	5.6
	20 + 20 + 60		1.20	1.20	3.60	2.1	6.0	7.5	350	1320	2280	6.1	5.8	5.6
	20 + 25 + 25		1.71	2.14	2.14	2.1	6.0	7.5	350	1320	2280	6.1	5.8	5.6
	20 + 25 + 35		1.50	1.88	2.63	2.1	6.0	7.5	350	1320	2280	6.1	5.8	5.6
	20 + 25 + 50		1.26	1.58	3.16	2.1	6.0	7.5	350	1320	2280	6.1	5.8	5.6
	20 + 25 + 60		1.14	1.43	3.43	2.1	6.0	7.5	350	1320	2280	6.1	5.8	5.6
	20 + 35 + 35		1.33	2.33	2.33	2.1	6.0	7.5	350	1320	2280	6.1	5.8	5.6
	20 + 35 + 50		1.14	2.00	2.86	2.1	6.0	7.5	350	1320	2280	6.1	5.8	5.6
25 + 25 + 25	2.00		2.00	2.00	2.1	6.0	7.5	350	1320	2280	6.1	5.8	5.6	
25 + 25 + 35	1.76		1.76	2.47	2.1	6.0	7.5	350	1320	2280	6.1	5.8	5.6	
25 + 25 + 50	1.50		1.50	3.00	2.1	6.0	7.5	350	1320	2280	6.1	5.8	5.6	
25 + 25 + 60	1.36		1.36	3.27	2.1	6.0	7.5	350	1320	2280	6.1	5.8	5.6	
25 + 35 + 35	1.58	2.21	2.21	2.1	6.0	7.5	350	1320	2280	6.1	5.8	5.6		
25 + 35 + 50	1.36	1.91	2.73	2.1	6.0	7.5	350	1320	2280	6.1	5.8	5.6		
35 + 35 + 35	2.00	2.00	2.00	2.1	6.0	7.5	350	1320	2280	6.1	5.8	5.6		

COMBINATIONS

SCM60ZS-W Table of Indoor unit combination with other indoor unit

Indoor unit combination		Heating capacity (kW)						Power consumption(W)			Standard current(A)			
		Room heating capacity			Total capacity			Min.	Standard	Max.	220V	230V	240V	
		A	B	C	Min.	Standard	Max.							
Heating operation	1 room	20	3.00	-	-	1.0	3.0	3.5	320	970	1330	4.5	4.3	4.1
		25	3.40	-	-	1.0	3.4	4.0	320	1140	1510	5.3	5.1	4.8
		35	4.50	-	-	1.0	4.5	4.8	320	1480	1790	6.9	6.6	6.3
		50	5.80	-	-	1.0	5.8	6.1	320	1910	2310	8.9	8.5	8.1
		60	6.80	-	-	1.0	6.8	7.0	320	2200	2660	10.2	9.8	9.4
	2 room	20 + 20	2.70	2.70	-	1.2	5.4	7.0	290	1250	2100	5.8	5.5	5.3
		20 + 25	2.62	3.28	-	1.2	5.9	7.2	290	1380	2550	6.4	6.1	5.9
		20 + 35	2.40	4.20	-	1.2	6.6	7.3	290	1560	2800	7.2	6.9	6.6
		20 + 50	1.94	4.86	-	1.2	6.8	7.3	290	1640	2800	7.6	7.3	7.0
		20 + 60	1.70	5.10	-	1.2	6.8	7.3	290	1640	2800	7.6	7.3	7.0
		25 + 25	3.20	3.20	-	1.2	6.4	7.3	290	1510	2800	7.0	6.7	6.4
		25 + 35	2.83	3.97	-	1.2	6.8	7.3	290	1640	2800	7.6	7.3	7.0
		25 + 50	2.27	4.53	-	1.2	6.8	7.3	290	1640	2800	7.6	7.3	7.0
		25 + 60	2.00	4.80	-	1.2	6.8	7.3	290	1640	2800	7.6	7.3	7.0
		35 + 35	3.40	3.40	-	1.2	6.8	7.3	290	1640	2800	7.6	7.3	7.0
		35 + 50	2.80	4.00	-	1.2	6.8	7.3	290	1640	2800	7.6	7.3	7.0
		35 + 60	2.51	4.29	-	1.2	6.8	7.3	290	1640	2800	7.6	7.3	7.0
		50 + 50	3.40	3.40	-	1.2	6.8	7.3	290	1640	2800	7.6	7.3	7.0
		50 + 60	3.09	3.71	-	1.2	6.8	7.3	290	1640	2800	7.6	7.3	7.0
		3 room	20 + 20 + 20	2.27	2.27	2.27	1.4	6.8	7.6	270	1500	2800	7.0	6.7
	20 + 20 + 25		2.09	2.09	2.62	1.4	6.8	7.6	270	1500	2800	7.0	6.7	6.4
	20 + 20 + 35		1.81	1.81	3.17	1.4	6.8	7.6	270	1500	2800	7.0	6.7	6.4
	20 + 20 + 50		1.51	1.51	3.78	1.4	6.8	7.6	270	1500	2800	7.0	6.7	6.4
	20 + 20 + 60		1.36	1.36	4.08	1.4	6.8	7.6	270	1500	2800	7.0	6.7	6.4
	20 + 25 + 25		1.94	2.43	2.43	1.4	6.8	7.6	270	1500	2800	7.0	6.7	6.4
	20 + 25 + 35		1.70	2.13	2.98	1.4	6.8	7.6	270	1500	2800	7.0	6.7	6.4
	20 + 25 + 50		1.43	1.79	3.58	1.4	6.8	7.6	270	1500	2800	7.0	6.7	6.4
	20 + 25 + 60		1.30	1.62	3.89	1.4	6.8	7.6	270	1500	2800	7.0	6.7	6.4
	20 + 35 + 35		1.51	2.64	2.64	1.4	6.8	7.6	270	1500	2800	7.0	6.7	6.4
	20 + 35 + 50		1.30	2.27	3.24	1.4	6.8	7.6	270	1500	2800	7.0	6.7	6.4
	25 + 25 + 25		2.27	2.27	2.27	1.4	6.8	7.6	270	1500	2800	7.0	6.7	6.4
	25 + 25 + 35		2.00	2.00	2.80	1.4	6.8	7.6	270	1500	2800	7.0	6.7	6.4
	25 + 25 + 50	1.70	1.70	3.40	1.4	6.8	7.6	270	1500	2800	7.0	6.7	6.4	
25 + 25 + 60	1.55	1.55	3.71	1.4	6.8	7.6	270	1500	2800	7.0	6.7	6.4		
25 + 35 + 35	1.79	2.51	2.51	1.4	6.8	7.6	270	1500	2800	7.0	6.7	6.4		
25 + 35 + 50	1.55	2.16	3.09	1.4	6.8	7.6	270	1500	2800	7.0	6.7	6.4		
35 + 35 + 35	2.27	2.27	2.27	1.4	6.8	7.6	270	1500	2800	7.0	6.7	6.4		

Indoor unit combination		Cooling capacity (kW)						Power consumption(W)			Standard current(A)			
		Room cooling capacity			Total capacity			Min.	Standard	Max.	220V	230V	240V	
		A	B	C	Min.	Standard	Max.							
Cooling operation	1 room	20	2.00	-	-	1.7	2.0	2.7	430	570	950	2.7	2.6	2.5
		25	2.50	-	-	1.7	2.5	3.2	430	760	1080	3.6	3.4	3.3
		35	3.50	-	-	1.7	3.5	3.7	430	1150	1240	5.3	5.1	4.9
		50	5.00	-	-	1.7	5.0	5.8	430	1860	2100	8.5	8.2	7.8
		60	6.00	-	-	1.7	6.0	6.1	430	2140	2280	9.8	9.4	9.0
	2 room	20 + 20	2.00	2.00	-	1.8	4.0	5.6	390	800	1750	3.7	3.5	3.4
		20 + 25	2.00	2.50	-	1.8	4.5	5.8	390	1050	1910	4.8	4.6	4.4
		20 + 35	2.00	3.50	-	1.8	5.5	6.1	390	1620	2110	7.4	7.1	6.8
		20 + 50	1.71	4.29	-	1.8	6.0	6.7	390	1930	2280	8.9	8.5	8.1
		20 + 60	1.50	4.50	-	1.8	6.0	6.7	390	1930	2280	8.9	8.5	8.1
		25 + 25	2.50	2.50	-	1.8	5.0	6.1	390	1340	2110	6.2	5.9	5.6
		25 + 35	2.50	3.50	-	1.8	6.0	6.7	390	1930	2280	8.9	8.5	8.1
		25 + 50	2.00	4.00	-	1.8	6.0	6.7	390	1930	2280	8.9	8.5	8.1
		25 + 60	1.76	4.24	-	1.8	6.0	6.7	390	1930	2280	8.9	8.5	8.1
		35 + 35	3.00	3.00	-	1.8	6.0	6.7	390	1930	2280	8.9	8.5	8.1
		35 + 50	2.47	3.53	-	1.8	6.0	6.7	390	1930	2280	8.9	8.5	8.1
		35 + 60	2.21	3.79	-	1.8	6.0	6.7	390	1930	2280	8.9	8.5	8.1
		50 + 50	3.00	3.00	-	1.8	6.0	6.7	390	1930	2280	8.9	8.5	8.1
		50 + 60	2.73	3.27	-	1.8	6.0	6.7	390	1930	2280	8.9	8.5	8.1
		3 room	20 + 20 + 20	2.00	2.00	2.00	2.1	6.0	7.3	350	1430	2280	6.6	6.3
	20 + 20 + 25		1.85	1.85	2.31	2.1	6.0	7.3	350	1430	2280	6.6	6.3	6.0
	20 + 20 + 35		1.60	1.60	2.80	2.1	6.0	7.3	350	1430	2280	6.6	6.3	6.0
	20 + 20 + 50		1.33	1.33	3.33	2.1	6.0	7.3	350	1430	2280	6.6	6.3	6.0
	20 + 20 + 60		1.20	1.20	3.60	2.1	6.0	7.3	350	1430	2280	6.6	6.3	6.0
	20 + 25 + 25		1.71	2.14	2.14	2.1	6.0	7.3	350	1430	2280	6.6	6.3	6.0
	20 + 25 + 35		1.50	1.88	2.63	2.1	6.0	7.3	350	1430	2280	6.6	6.3	6.0
	20 + 25 + 50		1.26	1.58	3.16	2.1	6.0	7.3	350	1430	2280	6.6	6.3	6.0
	20 + 25 + 60		1.14	1.43	3.43	2.1	6.0	7.3	350	1430	2280	6.6	6.3	6.0
	20 + 35 + 35		1.33	2.33	2.33	2.1	6.0	7.3	350	1430	2280	6.6	6.3	6.0
	20 + 35 + 50		1.14	2.00	2.86	2.1	6.0	7.3	350	1430	2280	6.6	6.3	6.0
	25 + 25 + 25		2.00	2.00	2.00	2.1	6.0	7.3	350	1430	2280	6.6	6.3	6.0
	25 + 25 + 35		1.76	1.76	2.47	2.1	6.0	7.3	350	1430	2280	6.6	6.3	6.0
	25 + 25 + 50	1.50	1.50	3.00	2.1	6.0	7.3	350	1430	2280	6.6	6.3	6.0	
25 + 25 + 60	1.36	1.36	3.27	2.1	6.0	7.3	350	1430	2280	6.6	6.3	6.0		
25 + 35 + 35	1.58	2.21	2.21	2.1	6.0	7.3	350	1430	2280	6.6	6.3	6.0		
25 + 35 + 50	1.36	1.91	2.73	2.1	6.0	7.3	350	1430	2280	6.6	6.3	6.0		
35 + 35 + 35	2.00	2.00	2.00	2.1	6.0	7.3	350	1430	2280	6.6	6.3	6.0		



MULTI-SPLIT SYSTEM

SCM71ZS-W Table of Indoor unit combination only with SRK-ZSX type

Indoor unit combination		Heating capacity (kW)							Power consumption(W)			Standard current(A)		
		Room heating capacity				Total capacity			Min.	Standard	Max.	220V	230V	240V
		A	B	C	D	Min.	Standard	Max.						
1 room	20	3.00	-	-	-	1.1	3.0	3.7	390	840	1330	4.0	3.8	3.6
	25	3.40	-	-	-	1.1	3.4	4.2	390	1000	1510	4.7	4.5	4.3
	35	4.50	-	-	-	1.1	4.5	5.0	390	1330	1790	6.2	5.9	5.7
	50	5.80	-	-	-	1.1	5.8	6.5	390	1780	2310	8.3	7.9	7.6
	60	6.80	-	-	-	1.1	6.8	7.5	390	2100	2660	9.7	9.3	8.9
2 room	20 + 20	2.70	2.70	-	-	1.5	5.4	7.4	350	1280	1870	6.0	5.7	5.5
	20 + 25	2.62	3.28	-	-	1.5	5.9	7.7	350	1410	2130	6.6	6.3	6.0
	20 + 35	2.51	4.39	-	-	1.5	6.9	8.3	350	1680	2650	7.8	7.5	7.1
	20 + 50	2.46	6.14	-	-	1.5	8.6	8.9	350	2100	3000	9.7	9.3	8.9
	20 + 60	2.15	6.45	-	-	1.5	8.6	8.9	350	2100	3000	9.7	9.3	8.9
	25 + 25	3.20	3.20	-	-	1.5	6.4	8.1	350	1540	2480	7.1	6.8	6.5
	25 + 35	3.08	4.32	-	-	1.5	7.4	8.6	350	1810	2910	8.4	8.0	7.7
	25 + 50	2.87	5.73	-	-	1.5	8.6	8.9	350	2100	3000	9.7	9.3	8.9
	25 + 60	2.53	6.07	-	-	1.5	8.6	8.9	350	2100	3000	9.7	9.3	8.9
	35 + 35	4.30	4.30	-	-	1.5	8.6	8.9	350	2100	3000	9.7	9.3	8.9
	35 + 50	3.54	5.06	-	-	1.5	8.6	8.9	350	2100	3000	9.7	9.3	8.9
	35 + 60	3.17	5.43	-	-	1.5	8.6	8.9	350	2100	3000	9.7	9.3	8.9
	50 + 50	4.30	4.30	-	-	1.5	8.6	8.9	350	2100	3000	9.7	9.3	8.9
	50 + 60	3.91	4.69	-	-	1.5	8.6	8.9	350	2100	3000	9.7	9.3	8.9
	60 + 60	4.30	4.30	-	-	1.5	8.6	8.9	350	2100	3000	9.7	9.3	8.9
3 room	20 + 20 + 20	2.57	2.57	2.57	-	1.6	7.7	9.1	370	1830	3000	8.5	8.1	7.8
	20 + 20 + 25	2.46	2.46	3.08	-	1.6	8.0	9.1	370	1930	3000	9.0	8.6	8.2
	20 + 20 + 35	2.29	2.29	4.01	-	1.6	8.6	9.1	370	2060	3000	9.6	9.1	8.8
	20 + 20 + 50	1.91	1.91	4.78	-	1.6	8.6	9.1	370	2060	3000	9.6	9.1	8.8
	20 + 20 + 60	1.72	1.72	5.16	-	1.6	8.6	9.1	370	2060	3000	9.6	9.1	8.8
	20 + 25 + 25	2.46	3.07	3.07	-	1.6	8.6	9.1	370	2060	3000	9.6	9.1	8.8
	20 + 25 + 35	2.15	2.69	3.76	-	1.6	8.6	9.1	370	2060	3000	9.6	9.1	8.8
	20 + 25 + 50	1.81	2.26	4.53	-	1.6	8.6	9.1	370	2060	3000	9.6	9.1	8.8
	20 + 25 + 60	1.64	2.05	4.91	-	1.6	8.6	9.1	370	2060	3000	9.6	9.1	8.8
	20 + 35 + 35	1.91	3.34	3.34	-	1.6	8.6	9.1	370	2060	3000	9.6	9.1	8.8
	20 + 35 + 50	1.64	2.87	4.10	-	1.6	8.6	9.1	370	2060	3000	9.6	9.1	8.8
	20 + 35 + 60	1.50	2.62	4.49	-	1.6	8.6	9.1	370	2060	3000	9.6	9.1	8.8
	20 + 50 + 50	1.43	3.58	3.58	-	1.6	8.6	9.1	370	2060	3000	9.6	9.1	8.8
	25 + 25 + 25	2.87	2.87	2.87	-	1.6	8.6	9.1	370	2060	3000	9.6	9.1	8.8
	25 + 25 + 35	2.53	2.53	3.54	-	1.6	8.6	9.1	370	2060	3000	9.6	9.1	8.8
	25 + 25 + 50	2.15	2.15	4.30	-	1.6	8.6	9.1	370	2060	3000	9.6	9.1	8.8
	25 + 25 + 60	1.95	1.95	4.69	-	1.6	8.6	9.1	370	2060	3000	9.6	9.1	8.8
	25 + 35 + 35	2.26	3.17	3.17	-	1.6	8.6	9.1	370	2060	3000	9.6	9.1	8.8
	25 + 35 + 50	1.95	2.74	3.91	-	1.6	8.6	9.1	370	2060	3000	9.6	9.1	8.8
	25 + 35 + 60	1.79	2.51	4.30	-	1.6	8.6	9.1	370	2060	3000	9.6	9.1	8.8
25 + 50 + 50	1.72	3.44	3.44	-	1.6	8.6	9.1	370	2060	3000	9.6	9.1	8.8	
35 + 35 + 35	2.87	2.87	2.87	-	1.6	8.6	9.1	370	2060	3000	9.6	9.1	8.8	
35 + 35 + 50	2.51	2.51	3.58	-	1.6	8.6	9.1	370	2060	3000	9.6	9.1	8.8	
4 room	20 + 20 + 20 + 20	2.15	2.15	2.15	2.15	1.7	8.6	9.4	350	1750	3000	8.1	7.8	7.4
	20 + 20 + 20 + 25	2.02	2.02	2.02	2.53	1.7	8.6	9.4	350	1750	3000	8.1	7.8	7.4
	20 + 20 + 20 + 35	1.81	1.81	1.81	3.17	1.7	8.6	9.4	350	1750	3000	8.1	7.8	7.4
	20 + 20 + 20 + 50	1.56	1.56	1.56	3.91	1.7	8.6	9.4	350	1750	3000	8.1	7.8	7.4
	20 + 20 + 20 + 60	1.43	1.43	1.43	4.30	1.7	8.6	9.4	350	1750	3000	8.1	7.8	7.4
	20 + 20 + 25 + 25	1.91	1.91	2.39	2.39	1.7	8.6	9.4	350	1750	3000	8.1	7.8	7.4
	20 + 20 + 25 + 35	1.72	1.72	2.15	3.01	1.7	8.6	9.4	350	1750	3000	8.1	7.8	7.4
	20 + 20 + 25 + 50	1.50	1.50	1.87	3.74	1.7	8.6	9.4	350	1750	3000	8.1	7.8	7.4
	20 + 20 + 25 + 60	1.38	1.38	1.72	4.13	1.7	8.6	9.4	350	1750	3000	8.1	7.8	7.4
	20 + 20 + 35 + 35	1.56	1.56	2.74	2.74	1.7	8.6	9.4	350	1750	3000	8.1	7.8	7.4
	20 + 20 + 35 + 50	1.38	1.38	2.41	3.44	1.7	8.6	9.4	350	1750	3000	8.1	7.8	7.4
	20 + 25 + 25 + 25	1.81	2.26	2.26	2.26	1.7	8.6	9.4	350	1750	3000	8.1	7.8	7.4
	20 + 25 + 25 + 35	1.64	2.05	2.05	2.87	1.7	8.6	9.4	350	1750	3000	8.1	7.8	7.4
	20 + 25 + 25 + 50	1.43	1.79	1.79	3.58	1.7	8.6	9.4	350	1750	3000	8.1	7.8	7.4
	20 + 25 + 35 + 35	1.50	1.87	2.62	2.62	1.7	8.6	9.4	350	1750	3000	8.1	7.8	7.4
	20 + 35 + 35 + 35	1.38	2.41	2.41	2.41	1.7	8.6	9.4	350	1750	3000	8.1	7.8	7.4
	25 + 25 + 25 + 25	2.15	2.15	2.15	2.15	1.7	8.6	9.4	350	1750	3000	8.1	7.8	7.4
	25 + 25 + 25 + 35	1.95	1.95	1.95	2.74	1.7	8.6	9.4	350	1750	3000	8.1	7.8	7.4
25 + 25 + 25 + 50	1.72	1.72	1.72	3.44	1.7	8.6	9.4	350	1750	3000	8.1	7.8	7.4	
25 + 25 + 35 + 35	1.79	1.79	2.51	2.51	1.7	8.6	9.4	350	1750	3000	8.1	7.8	7.4	

COMBINATIONS

Indoor unit combination		Cooling capacity (kW)							Power consumption(W)			Standard current(A)		
		Room cooling capacity				Total capacity			Min.	Standard	Max.	220V	230V	240V
		A	B	C	D	Min.	Standard	Max.						
1 room	20	2.00	-	-	-	1.8	2.0	3.4	480	500	950	2.4	2.3	2.2
	25	2.50	-	-	-	1.8	2.5	3.8	480	680	1080	3.2	3.1	3.0
	35	3.50	-	-	-	1.8	3.5	4.5	480	1010	1240	4.7	4.5	4.3
	50	5.00	-	-	-	1.8	5.0	6.2	480	1530	2100	7.0	6.7	6.4
	60	6.00	-	-	-	1.8	6.0	6.9	480	1880	2700	8.6	8.3	7.9
2 room	20 + 20	2.00	2.00	-	-	3.0	4.0	6.1	550	840	1910	4.0	3.8	3.6
	20 + 25	2.00	2.50	-	-	3.0	4.5	6.4	550	990	2060	4.6	4.4	4.3
	20 + 35	2.00	3.50	-	-	3.0	5.5	6.9	550	1320	2320	6.1	5.8	5.6
	20 + 50	2.03	5.07	-	-	3.0	7.1	7.7	550	1970	2750	9.0	8.7	8.3
	20 + 60	1.78	5.33	-	-	3.0	7.1	7.7	550	1970	2750	9.0	8.7	8.3
	25 + 25	2.50	2.50	-	-	3.0	5.0	6.8	550	1150	2270	5.4	5.1	4.9
	25 + 35	2.46	3.44	-	-	3.0	5.9	7.2	550	1470	2470	6.8	6.5	6.2
	25 + 50	2.37	4.73	-	-	3.0	7.1	7.7	550	1970	2750	9.0	8.7	8.3
	25 + 60	2.09	5.01	-	-	3.0	7.1	7.7	550	1970	2750	9.0	8.7	8.3
	35 + 35	3.55	3.55	-	-	3.0	7.1	7.7	550	1970	2750	9.0	8.7	8.3
	35 + 50	2.92	4.18	-	-	3.0	7.1	7.7	550	1970	2750	9.0	8.7	8.3
	35 + 60	2.62	4.48	-	-	3.0	7.1	7.7	550	1970	2750	9.0	8.7	8.3
	50 + 50	3.55	3.55	-	-	3.0	7.1	7.7	550	1970	2750	9.0	8.7	8.3
	50 + 60	3.23	3.87	-	-	3.0	7.1	7.7	550	1970	2750	9.0	8.7	8.3
	60 + 60	3.55	3.55	-	-	3.0	7.1	7.7	550	1970	2750	9.0	8.7	8.3
	3 room	20 + 20 + 20	2.00	2.00	2.00	-	3.7	6.0	8.2	670	1240	2750	5.8	5.5
20 + 20 + 25		2.00	2.00	2.50	-	3.7	6.5	8.2	670	1390	2750	6.4	6.1	5.9
20 + 20 + 35		1.89	1.89	3.31	-	3.7	7.1	8.2	670	1520	2750	7.0	6.7	6.4
20 + 20 + 50		1.58	1.58	3.94	-	3.7	7.1	8.2	670	1520	2750	7.0	6.7	6.4
20 + 20 + 60		1.42	1.42	4.26	-	3.7	7.1	8.2	670	1520	2750	7.0	6.7	6.4
20 + 25 + 25		2.03	2.54	2.54	-	3.7	7.1	8.2	670	1520	2750	7.0	6.7	6.4
20 + 25 + 35		1.78	2.22	3.11	-	3.7	7.1	8.2	670	1520	2750	7.0	6.7	6.4
20 + 25 + 50		1.49	1.87	3.74	-	3.7	7.1	8.2	670	1520	2750	7.0	6.7	6.4
20 + 25 + 60		1.35	1.69	4.06	-	3.7	7.1	8.2	670	1520	2750	7.0	6.7	6.4
20 + 35 + 35		1.58	2.76	2.76	-	3.7	7.1	8.2	670	1520	2750	7.0	6.7	6.4
20 + 35 + 50		1.35	2.37	3.38	-	3.7	7.1	8.2	670	1520	2750	7.0	6.7	6.4
20 + 35 + 60		1.23	2.16	3.70	-	3.7	7.1	8.2	670	1520	2750	7.0	6.7	6.4
20 + 50 + 50		1.18	2.96	2.96	-	3.7	7.1	8.2	670	1520	2750	7.0	6.7	6.4
25 + 25 + 25		2.37	2.37	2.37	-	3.7	7.1	8.2	670	1520	2750	7.0	6.7	6.4
25 + 25 + 35		2.09	2.09	2.92	-	3.7	7.1	8.2	670	1520	2750	7.0	6.7	6.4
25 + 25 + 50		1.78	1.78	3.55	-	3.7	7.1	8.2	670	1520	2750	7.0	6.7	6.4
25 + 25 + 60		1.61	1.61	3.87	-	3.7	7.1	8.2	670	1520	2750	7.0	6.7	6.4
25 + 35 + 35		1.87	2.62	2.62	-	3.7	7.1	8.2	670	1520	2750	7.0	6.7	6.4
25 + 35 + 50		1.61	2.26	3.23	-	3.7	7.1	8.2	670	1520	2750	7.0	6.7	6.4
25 + 35 + 60		1.48	2.07	3.55	-	3.7	7.1	8.2	670	1520	2750	7.0	6.7	6.4
25 + 50 + 50	1.42	2.84	2.84	-	3.7	7.1	8.2	670	1520	2750	7.0	6.7	6.4	
35 + 35 + 35	2.37	2.37	2.37	-	3.7	7.1	8.2	670	1520	2750	7.0	6.7	6.4	
35 + 35 + 50	2.07	2.07	2.96	-	3.7	7.1	8.2	670	1520	2750	7.0	6.7	6.4	
4 room	20 + 20 + 20 + 20	1.78	1.78	1.78	1.78	4.4	7.1	8.8	890	1420	2750	6.5	6.2	6.0
	20 + 20 + 20 + 25	1.67	1.67	1.67	2.09	4.4	7.1	8.8	890	1420	2750	6.5	6.2	6.0
	20 + 20 + 20 + 35	1.49	1.49	1.49	2.62	4.4	7.1	8.8	890	1420	2750	6.5	6.2	6.0
	20 + 20 + 20 + 50	1.29	1.29	1.29	3.23	4.4	7.1	8.8	890	1420	2750	6.5	6.2	6.0
	20 + 20 + 20 + 60	1.18	1.18	1.18	3.55	4.4	7.1	8.8	890	1420	2750	6.5	6.2	6.0
	20 + 20 + 25 + 25	1.58	1.58	1.97	1.97	4.4	7.1	8.8	890	1420	2750	6.5	6.2	6.0
	20 + 20 + 25 + 35	1.42	1.42	1.78	2.49	4.4	7.1	8.8	890	1420	2750	6.5	6.2	6.0
	20 + 20 + 25 + 50	1.23	1.23	1.54	3.09	4.4	7.1	8.8	890	1420	2750	6.5	6.2	6.0
	20 + 20 + 25 + 60	1.14	1.14	1.42	3.41	4.4	7.1	8.8	890	1420	2750	6.5	6.2	6.0
	20 + 20 + 35 + 35	1.29	1.29	2.26	2.26	4.4	7.1	8.8	890	1420	2750	6.5	6.2	6.0
	20 + 20 + 35 + 50	1.14	1.14	1.99	2.84	4.4	7.1	8.8	890	1420	2750	6.5	6.2	6.0
	20 + 25 + 25 + 25	1.49	1.87	1.87	1.87	4.4	7.1	8.8	890	1420	2750	6.5	6.2	6.0
	20 + 25 + 25 + 35	1.35	1.69	1.69	2.37	4.4	7.1	8.8	890	1420	2750	6.5	6.2	6.0
	20 + 25 + 25 + 50	1.18	1.48	1.48	2.96	4.4	7.1	8.8	890	1420	2750	6.5	6.2	6.0
	20 + 25 + 35 + 35	1.23	1.54	2.16	2.16	4.4	7.1	8.8	890	1420	2750	6.5	6.2	6.0
	20 + 35 + 35 + 35	1.14	1.99	1.99	1.99	4.4	7.1	8.8	890	1420	2750	6.5	6.2	6.0
	25 + 25 + 25 + 25	1.78	1.78	1.78	1.78	4.4	7.1	8.8	890	1420	2750	6.5	6.2	6.0
	25 + 25 + 25 + 35	1.61	1.61	1.61	2.26	4.4	7.1	8.8	890	1420	2750	6.5	6.2	6.0
25 + 25 + 25 + 50	1.42	1.42	1.42	2.84	4.4	7.1	8.8	890	1420	2750	6.5	6.2	6.0	
25 + 25 + 35 + 35	1.48	1.48	2.07	2.07	4.4	7.1	8.8	890	1420	2750	6.5	6.2	6.0	



MULTI-SPLIT SYSTEM

SCM71ZS-W Table of Indoor unit combination with other indoor unit

Indoor unit combination		Heating capacity (kW)						Power consumption(W)			Standard current(A)			
		Room heating capacity				Total capacity		Min.	Standard	Max.	220V	230V	240V	
		A	B	C	D	Min.	Standard							Max.
1 room	20	3.00	-	-	-	1.1	3.0	3.5	390	1060	1330	5.0	4.8	4.6
	25	3.40	-	-	-	1.1	3.4	4.0	390	1220	1510	5.7	5.5	5.2
	35	4.50	-	-	-	1.1	4.5	4.8	390	1510	1790	7.0	6.7	6.4
	50	5.80	-	-	-	1.1	5.8	6.2	390	1950	2310	9.0	8.7	8.3
	60	6.80	-	-	-	1.1	6.8	7.1	390	2240	2660	10.4	9.9	9.5
2 room	71	8.00	-	-	-	1.1	8.0	8.1	390	2740	3000	12.7	12.2	11.6
	20 + 20	2.70	2.70	-	-	1.5	5.4	7.0	350	1370	1870	6.4	6.1	5.9
	20 + 25	2.62	3.28	-	-	1.5	5.9	7.3	350	1560	2130	7.3	6.9	6.7
	20 + 35	2.51	4.39	-	-	1.5	6.9	7.9	350	1950	2650	9.0	8.7	8.3
	20 + 50	2.46	6.14	-	-	1.5	8.6	8.7	350	2460	3000	11.4	10.9	10.5
	20 + 60	2.15	6.45	-	-	1.5	8.6	8.7	350	2460	3000	11.4	10.9	10.5
	20 + 71	1.89	6.71	-	-	1.5	8.6	8.7	350	2460	3000	11.4	10.9	10.5
	25 + 25	3.20	3.20	-	-	1.5	6.4	7.7	350	1740	2480	8.1	7.7	7.4
	25 + 35	3.08	4.32	-	-	1.5	7.4	8.2	350	2130	2910	9.9	9.4	9.1
	25 + 50	2.87	5.73	-	-	1.5	8.6	8.7	350	2460	3000	11.4	10.9	10.5
	25 + 60	2.53	6.07	-	-	1.5	8.6	8.7	350	2460	3000	11.4	10.9	10.5
	25 + 71	2.24	6.36	-	-	1.5	8.6	8.7	350	2460	3000	11.4	10.9	10.5
	35 + 35	4.30	4.30	-	-	1.5	8.6	8.7	350	2460	3000	11.4	10.9	10.5
	35 + 50	3.54	5.06	-	-	1.5	8.6	8.7	350	2460	3000	11.4	10.9	10.5
	35 + 60	3.17	5.43	-	-	1.5	8.6	8.7	350	2460	3000	11.4	10.9	10.5
	35 + 71	2.84	5.76	-	-	1.5	8.6	8.7	350	2460	3000	11.4	10.9	10.5
	50 + 50	4.30	4.30	-	-	1.5	8.6	8.7	350	2460	3000	11.4	10.9	10.5
50 + 60	3.91	4.69	-	-	1.5	8.6	8.7	350	2460	3000	11.4	10.9	10.5	
50 + 71	3.55	5.05	-	-	1.5	8.6	8.7	350	2460	3000	11.4	10.9	10.5	
60 + 60	4.30	4.30	-	-	1.5	8.6	8.7	350	2460	3000	11.4	10.9	10.5	
3 room	20 + 20 + 20	2.57	2.57	2.57	-	1.6	7.7	8.9	370	1870	3000	8.7	8.3	8.0
	20 + 20 + 25	2.46	2.46	3.08	-	1.6	8.0	8.9	370	1970	3000	9.1	8.7	8.4
	20 + 20 + 35	2.29	2.29	4.01	-	1.6	8.6	8.9	370	2410	3000	11.2	10.7	10.2
	20 + 20 + 50	1.91	1.91	4.78	-	1.6	8.6	8.9	370	2410	3000	11.2	10.7	10.2
	20 + 20 + 60	1.72	1.72	5.16	-	1.6	8.6	8.9	370	2410	3000	11.2	10.7	10.2
	20 + 20 + 71	1.55	1.55	5.50	-	1.6	8.6	8.9	370	2410	3000	11.2	10.7	10.2
	20 + 25 + 25	2.46	3.07	3.07	-	1.6	8.6	8.9	370	2410	3000	11.2	10.7	10.2
	20 + 25 + 35	2.15	2.69	3.76	-	1.6	8.6	8.9	370	2410	3000	11.2	10.7	10.2
	20 + 25 + 50	1.81	2.26	4.53	-	1.6	8.6	8.9	370	2410	3000	11.2	10.7	10.2
	20 + 25 + 60	1.64	2.05	4.91	-	1.6	8.6	8.9	370	2410	3000	11.2	10.7	10.2
	20 + 25 + 71	1.48	1.85	5.26	-	1.6	8.6	8.9	370	2410	3000	11.2	10.7	10.2
	20 + 35 + 35	1.91	3.34	3.34	-	1.6	8.6	8.9	370	2410	3000	11.2	10.7	10.2
	20 + 35 + 50	1.64	2.87	4.10	-	1.6	8.6	8.9	370	2410	3000	11.2	10.7	10.2
	20 + 35 + 60	1.50	2.62	4.49	-	1.6	8.6	8.9	370	2410	3000	11.2	10.7	10.2
	20 + 35 + 71	1.37	2.39	4.85	-	1.6	8.6	8.9	370	2410	3000	11.2	10.7	10.2
	20 + 50 + 50	1.43	3.58	3.58	-	1.6	8.6	8.9	370	2410	3000	11.2	10.7	10.2
	25 + 25 + 25	2.87	2.87	2.87	-	1.6	8.6	8.9	370	2410	3000	11.2	10.7	10.2
	25 + 25 + 35	2.53	2.53	3.54	-	1.6	8.6	8.9	370	2410	3000	11.2	10.7	10.2
	25 + 25 + 50	2.15	2.15	4.30	-	1.6	8.6	8.9	370	2410	3000	11.2	10.7	10.2
	25 + 25 + 60	1.95	1.95	4.69	-	1.6	8.6	8.9	370	2410	3000	11.2	10.7	10.2
25 + 25 + 71	1.78	1.78	5.05	-	1.6	8.6	8.9	370	2410	3000	11.2	10.7	10.2	
25 + 35 + 35	2.26	3.17	3.17	-	1.6	8.6	8.9	370	2410	3000	11.2	10.7	10.2	
25 + 35 + 50	1.95	2.74	3.91	-	1.6	8.6	8.9	370	2410	3000	11.2	10.7	10.2	
25 + 35 + 60	1.79	2.51	4.30	-	1.6	8.6	8.9	370	2410	3000	11.2	10.7	10.2	
25 + 50 + 50	1.72	3.44	3.44	-	1.6	8.6	8.9	370	2410	3000	11.2	10.7	10.2	
35 + 35 + 35	2.87	2.87	2.87	-	1.6	8.6	8.9	370	2410	3000	11.2	10.7	10.2	
35 + 35 + 50	2.51	2.51	3.58	-	1.6	8.6	8.9	370	2410	3000	11.2	10.7	10.2	
4 room	20 + 20 + 20 + 20	2.15	2.15	2.15	2.15	1.7	8.6	9.1	350	1990	3000	9.2	8.8	8.5
	20 + 20 + 20 + 25	2.02	2.02	2.02	2.53	1.7	8.6	9.1	350	1990	3000	9.2	8.8	8.5
	20 + 20 + 20 + 35	1.81	1.81	1.81	3.17	1.7	8.6	9.1	350	1990	3000	9.2	8.8	8.5
	20 + 20 + 20 + 50	1.56	1.56	1.56	3.91	1.7	8.6	9.1	350	1990	3000	9.2	8.8	8.5
	20 + 20 + 20 + 60	1.43	1.43	1.43	4.30	1.7	8.6	9.1	350	1990	3000	9.2	8.8	8.5
	20 + 20 + 25 + 25	1.91	1.91	2.39	2.39	1.7	8.6	9.1	350	1990	3000	9.2	8.8	8.5
	20 + 20 + 25 + 35	1.72	1.72	2.15	3.01	1.7	8.6	9.1	350	1990	3000	9.2	8.8	8.5
	20 + 20 + 25 + 50	1.50	1.50	1.87	3.74	1.7	8.6	9.1	350	1990	3000	9.2	8.8	8.5
	20 + 20 + 25 + 60	1.38	1.38	1.72	4.13	1.7	8.6	9.1	350	1990	3000	9.2	8.8	8.5
	20 + 20 + 35 + 35	1.56	1.56	2.74	2.74	1.7	8.6	9.1	350	1990	3000	9.2	8.8	8.5
	20 + 20 + 35 + 50	1.38	1.38	2.41	3.44	1.7	8.6	9.1	350	1990	3000	9.2	8.8	8.5
	20 + 25 + 25 + 25	1.81	2.26	2.26	2.26	1.7	8.6	9.1	350	1990	3000	9.2	8.8	8.5
	20 + 25 + 25 + 35	1.64	2.05	2.05	2.87	1.7	8.6	9.1	350	1990	3000	9.2	8.8	8.5
	20 + 25 + 25 + 50	1.43	1.79	1.79	3.58	1.7	8.6	9.1	350	1990	3000	9.2	8.8	8.5
	20 + 25 + 35 + 35	1.50	1.87	2.62	2.62	1.7	8.6	9.1	350	1990	3000	9.2	8.8	8.5
	20 + 35 + 35 + 35	1.38	2.41	2.41	2.41	1.7	8.6	9.1	350	1990	3000	9.2	8.8	8.5
	25 + 25 + 25 + 25	2.15	2.15	2.15	2.15	1.7	8.6	9.1	350	1990	3000	9.2	8.8	8.5
25 + 25 + 25 + 35	1.95	1.95	1.95	2.74	1.7	8.6	9.1	350	1990	3000	9.2	8.8	8.5	
25 + 25 + 25 + 50	1.72	1.72	1.72	3.44	1.7	8.6	9.1	350	1990	3000	9.2	8.8	8.5	
25 + 25 + 35 + 35	1.79	1.79	2.51	2.51	1.7	8.6	9.1	350	1990	3000	9.2	8.8	8.5	

COMBINATIONS

Indoor unit combination		Cooling capacity (kW)							Power consumption(W)			Standard current(A)		
		Room cooling capacity				Total capacity			Min.	Standard	Max.	220V	230V	240V
		A	B	C	D	Min.	Standard	Max.						
1 room	20	2.00	-	-	-	1.8	2.0	2.7	480	530	950	2.5	2.4	2.3
	25	2.50	-	-	-	1.8	2.5	3.2	480	730	1080	3.5	3.3	3.2
	35	3.50	-	-	-	1.8	3.5	3.7	480	1120	1240	5.2	5.0	4.8
	50	5.00	-	-	-	1.8	5.0	5.8	480	1710	2100	7.9	7.5	7.2
	60	6.00	-	-	-	1.8	6.0	6.7	480	2140	2700	9.8	9.4	9.0
2 room	71	7.10	-	-	-	1.8	7.1	7.2	480	2430	2830	11.2	10.7	10.2
	20 + 20	2.00	2.00	-	-	3.0	4.0	5.8	550	930	1910	4.4	4.2	4.0
	20 + 25	2.00	2.50	-	-	3.0	4.5	6.1	550	1170	2060	5.5	5.2	5.0
	20 + 35	2.00	3.50	-	-	3.0	5.5	6.6	550	1590	2320	7.3	7.0	6.7
	20 + 50	2.03	5.07	-	-	3.0	7.1	7.3	550	2340	2750	10.7	10.3	9.8
	20 + 60	1.78	5.33	-	-	3.0	7.1	7.3	550	2340	2750	10.7	10.3	9.8
	20 + 71	1.56	5.54	-	-	3.0	7.1	7.3	550	2340	2750	10.7	10.3	9.8
	25 + 25	2.50	2.50	-	-	3.0	5.0	6.5	550	1360	2270	6.3	6.0	5.8
	25 + 35	2.46	3.44	-	-	3.0	5.9	6.8	550	1780	2470	8.2	7.8	7.5
	25 + 50	2.37	4.73	-	-	3.0	7.1	7.3	550	2340	2750	10.7	10.3	9.8
	25 + 60	2.09	5.01	-	-	3.0	7.1	7.3	550	2340	2750	10.7	10.3	9.8
	25 + 71	1.85	5.25	-	-	3.0	7.1	7.3	550	2340	2750	10.7	10.3	9.8
	35 + 35	3.55	3.55	-	-	3.0	7.1	7.3	550	2340	2750	10.7	10.3	9.8
	35 + 50	2.92	4.18	-	-	3.0	7.1	7.3	550	2340	2750	10.7	10.3	9.8
	35 + 60	2.62	4.48	-	-	3.0	7.1	7.3	550	2340	2750	10.7	10.3	9.8
	35 + 71	2.34	4.76	-	-	3.0	7.1	7.3	550	2340	2750	10.7	10.3	9.8
	50 + 50	3.55	3.55	-	-	3.0	7.1	7.3	550	2340	2750	10.7	10.3	9.8
	50 + 60	3.23	3.87	-	-	3.0	7.1	7.3	550	2340	2750	10.7	10.3	9.8
50 + 71	2.93	4.17	-	-	3.0	7.1	7.3	550	2340	2750	10.7	10.3	9.8	
60 + 60	3.55	3.55	-	-	3.0	7.1	7.3	550	2340	2750	10.7	10.3	9.8	
3 room	20 + 20 + 20	2.00	2.00	2.00	-	3.7	6.0	7.8	670	1440	2750	6.6	6.4	6.1
	20 + 20 + 25	2.00	2.00	2.50	-	3.7	6.5	7.8	670	1630	2750	7.5	7.2	6.9
	20 + 20 + 35	1.89	1.89	3.31	-	3.7	7.1	7.8	670	1870	2750	8.6	8.2	7.9
	20 + 20 + 50	1.58	1.58	3.94	-	3.7	7.1	7.8	670	1870	2750	8.6	8.2	7.9
	20 + 20 + 60	1.42	1.42	4.26	-	3.7	7.1	7.8	670	1870	2750	8.6	8.2	7.9
	20 + 20 + 71	1.28	1.28	4.54	-	3.7	7.1	7.8	670	1870	2750	8.6	8.2	7.9
	20 + 25 + 25	2.03	2.54	2.54	-	3.7	7.1	7.8	670	1870	2750	8.6	8.2	7.9
	20 + 25 + 35	1.78	2.22	3.11	-	3.7	7.1	7.8	670	1870	2750	8.6	8.2	7.9
	20 + 25 + 50	1.49	1.87	3.74	-	3.7	7.1	7.8	670	1870	2750	8.6	8.2	7.9
	20 + 25 + 60	1.35	1.69	4.06	-	3.7	7.1	7.8	670	1870	2750	8.6	8.2	7.9
	20 + 25 + 71	1.22	1.53	4.35	-	3.7	7.1	7.8	670	1870	2750	8.6	8.2	7.9
	20 + 35 + 35	1.58	2.76	2.76	-	3.7	7.1	7.8	670	1870	2750	8.6	8.2	7.9
	20 + 35 + 50	1.35	2.37	3.38	-	3.7	7.1	7.8	670	1870	2750	8.6	8.2	7.9
	20 + 35 + 60	1.23	2.16	3.70	-	3.7	7.1	7.8	670	1870	2750	8.6	8.2	7.9
	20 + 35 + 71	1.13	1.97	4.00	-	3.7	7.1	7.8	670	1870	2750	8.6	8.2	7.9
	20 + 50 + 50	1.18	2.96	2.96	-	3.7	7.1	7.8	670	1870	2750	8.6	8.2	7.9
	25 + 25 + 25	2.37	2.37	2.37	-	3.7	7.1	7.8	670	1870	2750	8.6	8.2	7.9
	25 + 25 + 35	2.09	2.09	2.92	-	3.7	7.1	7.8	670	1870	2750	8.6	8.2	7.9
	25 + 25 + 50	1.78	1.78	3.55	-	3.7	7.1	7.8	670	1870	2750	8.6	8.2	7.9
	25 + 25 + 60	1.61	1.61	3.87	-	3.7	7.1	7.8	670	1870	2750	8.6	8.2	7.9
25 + 25 + 71	1.47	1.47	4.17	-	3.7	7.1	7.8	670	1870	2750	8.6	8.2	7.9	
25 + 35 + 35	1.87	2.62	2.62	-	3.7	7.1	7.8	670	1870	2750	8.6	8.2	7.9	
25 + 35 + 50	1.61	2.26	3.23	-	3.7	7.1	7.8	670	1870	2750	8.6	8.2	7.9	
25 + 35 + 60	1.48	2.07	3.55	-	3.7	7.1	7.8	670	1870	2750	8.6	8.2	7.9	
25 + 50 + 50	1.42	2.84	2.84	-	3.7	7.1	7.8	670	1870	2750	8.6	8.2	7.9	
35 + 35 + 35	2.37	2.37	2.37	-	3.7	7.1	7.8	670	1870	2750	8.6	8.2	7.9	
35 + 35 + 50	2.07	2.07	2.96	-	3.7	7.1	7.8	670	1870	2750	8.6	8.2	7.9	
4 room	20 + 20 + 20 + 20	1.78	1.78	1.78	1.78	4.4	7.1	8.3	890	1780	2750	8.2	7.8	7.5
	20 + 20 + 20 + 25	1.67	1.67	1.67	2.09	4.4	7.1	8.3	890	1780	2750	8.2	7.8	7.5
	20 + 20 + 20 + 35	1.49	1.49	1.49	2.62	4.4	7.1	8.3	890	1780	2750	8.2	7.8	7.5
	20 + 20 + 20 + 50	1.29	1.29	1.29	3.23	4.4	7.1	8.3	890	1780	2750	8.2	7.8	7.5
	20 + 20 + 20 + 60	1.18	1.18	1.18	3.55	4.4	7.1	8.3	890	1780	2750	8.2	7.8	7.5
	20 + 20 + 25 + 25	1.58	1.58	1.97	1.97	4.4	7.1	8.3	890	1780	2750	8.2	7.8	7.5
	20 + 20 + 25 + 35	1.42	1.42	1.78	2.49	4.4	7.1	8.3	890	1780	2750	8.2	7.8	7.5
	20 + 20 + 25 + 50	1.23	1.23	1.54	3.09	4.4	7.1	8.3	890	1780	2750	8.2	7.8	7.5
	20 + 20 + 25 + 60	1.14	1.14	1.42	3.41	4.4	7.1	8.3	890	1780	2750	8.2	7.8	7.5
	20 + 20 + 35 + 35	1.29	1.29	2.26	2.26	4.4	7.1	8.3	890	1780	2750	8.2	7.8	7.5
	20 + 20 + 35 + 50	1.14	1.14	1.99	2.84	4.4	7.1	8.3	890	1780	2750	8.2	7.8	7.5
	20 + 25 + 25 + 25	1.49	1.87	1.87	1.87	4.4	7.1	8.3	890	1780	2750	8.2	7.8	7.5
	20 + 25 + 25 + 35	1.35	1.69	1.69	2.37	4.4	7.1	8.3	890	1780	2750	8.2	7.8	7.5
	20 + 25 + 25 + 50	1.18	1.48	1.48	2.96	4.4	7.1	8.3	890	1780	2750	8.2	7.8	7.5
	20 + 25 + 35 + 35	1.23	1.54	2.16	2.16	4.4	7.1	8.3	890	1780	2750	8.2	7.8	7.5
	20 + 35 + 35 + 35	1.14	1.99	1.99	1.99	4.4	7.1	8.3	890	1780	2750	8.2	7.8	7.5
	25 + 25 + 25 + 25	1.78	1.78	1.78	1.78	4.4	7.1	8.3	890	1780	2750	8.2	7.8	7.5
	25 + 25 + 25 + 35	1.61	1.61	1.61	2.26	4.4	7.1	8.3	890	1780	2750	8.2	7.8	7.5
25 + 25 + 25 + 50	1.42	1.42	1.42	2.84	4.4	7.1	8.3	890	1780	2750	8.2	7.8	7.5	
25 + 25 + 35 + 35	1.48	1.48	2.07	2.07	4.4	7.1	8.3	890	1780	2750	8.2	7.8	7.5	



MULTI-SPLIT SYSTEM

SCM80ZS-W Table of Indoor unit combination only with SRK-ZSX type

Indoor unit combination	Heating capacity (kW)							Power consumption(W)			Standard current(A)			
	Room heating capacity				Total capacity			Min.	Standard	Max.	220V	230V	240V	
	A	B	C	D	Min.	Standard	Max.							
1 room	20	3.00	-	-	-	1.1	3.0	3.7	390	840	1330	4.0	3.8	3.6
	25	3.40	-	-	-	1.1	3.4	4.2	390	1000	1510	4.7	4.5	4.3
	35	4.50	-	-	-	1.1	4.5	5.0	390	1330	1790	6.2	5.9	5.7
	50	5.80	-	-	-	1.1	5.8	6.5	390	1780	2310	8.3	7.9	7.6
	60	6.80	-	-	-	1.1	6.8	7.5	390	2100	2660	9.7	9.3	8.9
2 room	20 + 20	2.70	2.70	-	-	1.5	5.4	7.4	350	1280	1870	6.0	5.7	5.5
	20 + 25	2.62	3.28	-	-	1.5	5.9	7.7	350	1410	2130	6.6	6.3	6.0
	20 + 35	2.51	4.39	-	-	1.5	6.9	8.3	350	1680	2650	7.8	7.5	7.1
	20 + 50	2.46	6.14	-	-	1.5	8.6	9.5	350	2100	3120	9.7	9.3	8.9
	20 + 60	2.33	6.98	-	-	1.5	9.3	9.5	350	2300	3120	10.7	10.2	9.8
	25 + 25	3.20	3.20	-	-	1.5	6.4	8.1	350	1540	2480	7.1	6.8	6.5
	25 + 35	3.08	4.32	-	-	1.5	7.4	8.6	350	1810	2910	8.4	8.0	7.7
	25 + 50	2.87	5.57	-	-	1.5	8.6	9.5	350	2100	3120	9.7	9.3	8.9
	25 + 60	2.74	6.56	-	-	1.5	9.3	9.5	350	2300	3120	10.7	10.2	9.8
	35 + 35	4.30	4.30	-	-	1.5	8.6	9.5	350	2100	3120	9.7	9.3	8.9
	35 + 50	3.83	5.47	-	-	1.5	9.3	9.5	350	2300	3120	10.7	10.2	9.8
	35 + 60	3.43	5.87	-	-	1.5	9.3	9.5	350	2300	3120	10.7	10.2	9.8
	50 + 50	4.65	4.65	-	-	1.5	9.3	9.5	350	2300	3120	10.7	10.2	9.8
	50 + 60	4.23	5.07	-	-	1.5	9.3	9.5	350	2300	3120	10.7	10.2	9.8
	60 + 60	4.65	4.65	-	-	1.5	9.3	9.5	350	2300	3120	10.7	10.2	9.8
3 room	20 + 20 + 20	2.57	2.57	2.57	-	1.6	7.7	9.6	370	1830	3120	8.5	8.1	7.8
	20 + 20 + 25	2.46	2.46	3.08	-	1.6	8.0	9.6	370	1930	3120	9.0	8.6	8.2
	20 + 20 + 35	2.29	2.29	4.01	-	1.6	8.6	9.6	370	2060	3120	9.6	9.1	8.8
	20 + 20 + 50	2.07	2.07	5.17	-	1.6	9.3	9.6	370	2250	3120	10.4	10.0	9.6
	20 + 20 + 60	1.86	1.86	5.58	-	1.6	9.3	9.6	370	2250	3120	10.4	10.0	9.6
	20 + 25 + 25	2.46	3.07	3.07	-	1.6	8.6	9.6	370	2060	3120	9.6	9.1	8.8
	20 + 25 + 35	2.33	2.91	4.07	-	1.6	9.3	9.6	370	2250	3120	10.4	10.0	9.6
	20 + 25 + 50	1.96	2.45	4.89	-	1.6	9.3	9.6	370	2250	3120	10.4	10.0	9.6
	20 + 25 + 60	1.77	2.21	5.31	-	1.6	9.3	9.6	370	2250	3120	10.4	10.0	9.6
	20 + 35 + 35	2.07	3.62	3.62	-	1.6	9.3	9.6	370	2250	3120	10.4	10.0	9.6
	20 + 35 + 50	1.77	3.10	4.43	-	1.6	9.3	9.6	370	2250	3120	10.4	10.0	9.6
	20 + 35 + 60	1.62	2.83	4.85	-	1.6	9.3	9.6	370	2250	3120	10.4	10.0	9.6
	20 + 50 + 50	1.55	3.88	3.88	-	1.6	9.3	9.6	370	2250	3120	10.4	10.0	9.6
	20 + 50 + 60	1.43	3.58	4.29	-	1.6	9.3	9.6	370	2250	3120	10.4	10.0	9.6
	25 + 25 + 25	2.87	2.87	2.87	-	1.6	8.6	9.6	370	2060	3120	9.6	9.1	8.8
	25 + 25 + 35	2.74	2.74	3.83	-	1.6	9.3	9.6	370	2250	3120	10.4	10.0	9.6
	25 + 25 + 50	2.33	2.33	4.65	-	1.6	9.3	9.6	370	2250	3120	10.4	10.0	9.6
	25 + 25 + 60	2.11	2.11	5.07	-	1.6	9.3	9.6	370	2250	3120	10.4	10.0	9.6
	25 + 35 + 35	2.45	3.43	3.43	-	1.6	9.3	9.6	370	2250	3120	10.4	10.0	9.6
	25 + 35 + 50	2.11	2.96	4.23	-	1.6	9.3	9.6	370	2250	3120	10.4	10.0	9.6
	25 + 35 + 60	1.94	2.71	4.65	-	1.6	9.3	9.6	370	2250	3120	10.4	10.0	9.6
	25 + 50 + 50	1.86	3.72	3.72	-	1.6	9.3	9.6	370	2250	3120	10.4	10.0	9.6
	25 + 50 + 60	1.72	3.44	4.13	-	1.6	9.3	9.6	370	2250	3120	10.4	10.0	9.6
	35 + 35 + 35	3.10	3.10	3.10	-	1.6	9.3	9.6	370	2250	3120	10.4	10.0	9.6
	35 + 35 + 50	2.71	2.71	3.88	-	1.6	9.3	9.6	370	2250	3120	10.4	10.0	9.6
35 + 35 + 60	2.50	2.50	4.29	-	1.6	9.3	9.6	370	2250	3120	10.4	10.0	9.6	
35 + 50 + 50	2.41	3.44	3.44	-	1.6	9.3	9.6	370	2250	3120	10.4	10.0	9.6	
4 room	20 + 20 + 20 + 20	2.33	2.33	2.33	2.33	1.7	9.3	9.8	350	1950	3120	9.0	8.6	8.2
	20 + 20 + 20 + 25	2.19	2.19	2.19	2.74	1.7	9.3	9.8	350	1950	3120	9.0	8.6	8.2
	20 + 20 + 20 + 35	1.96	1.96	1.96	3.43	1.7	9.3	9.8	350	1950	3120	9.0	8.6	8.2
	20 + 20 + 20 + 50	1.69	1.69	1.69	4.23	1.7	9.3	9.8	350	1950	3120	9.0	8.6	8.2
	20 + 20 + 20 + 60	1.55	1.55	1.55	4.65	1.7	9.3	9.8	350	1950	3120	9.0	8.6	8.2
	20 + 20 + 25 + 25	2.07	2.07	2.58	2.58	1.7	9.3	9.8	350	1950	3120	9.0	8.6	8.2
	20 + 20 + 25 + 35	1.86	1.86	2.33	3.26	1.7	9.3	9.8	350	1950	3120	9.0	8.6	8.2
	20 + 20 + 25 + 50	1.62	1.62	2.02	4.04	1.7	9.3	9.8	350	1950	3120	9.0	8.6	8.2
	20 + 20 + 25 + 60	1.49	1.49	1.86	4.46	1.7	9.3	9.8	350	1950	3120	9.0	8.6	8.2
	20 + 20 + 35 + 35	1.69	1.69	2.96	2.96	1.7	9.3	9.8	350	1950	3120	9.0	8.6	8.2
	20 + 20 + 35 + 50	1.49	1.49	2.60	3.72	1.7	9.3	9.8	350	1950	3120	9.0	8.6	8.2
	20 + 20 + 35 + 60	1.38	1.38	2.41	4.13	1.7	9.3	9.8	350	1950	3120	9.0	8.6	8.2
	20 + 25 + 25 + 25	1.96	2.45	2.45	2.45	1.7	9.3	9.8	350	1950	3120	9.0	8.6	8.2
	20 + 25 + 25 + 35	1.77	2.21	2.21	3.10	1.7	9.3	9.8	350	1950	3120	9.0	8.6	8.2
	20 + 25 + 25 + 50	1.55	1.94	1.94	3.88	1.7	9.3	9.8	350	1950	3120	9.0	8.6	8.2
	20 + 25 + 25 + 60	1.43	1.79	1.79	4.29	1.7	9.3	9.8	350	1950	3120	9.0	8.6	8.2
	20 + 25 + 35 + 35	1.62	2.02	2.83	2.83	1.7	9.3	9.8	350	1950	3120	9.0	8.6	8.2
	20 + 25 + 35 + 50	1.43	1.79	2.50	3.58	1.7	9.3	9.8	350	1950	3120	9.0	8.6	8.2
	20 + 35 + 35 + 35	1.49	2.60	2.60	2.60	1.7	9.3	9.8	350	1950	3120	9.0	8.6	8.2
	25 + 25 + 25 + 25	2.33	2.33	2.33	2.33	1.7	9.3	9.8	350	1950	3120	9.0	8.6	8.2
	25 + 25 + 25 + 35	2.11	2.11	2.11	2.96	1.7	9.3	9.8	350	1950	3120	9.0	8.6	8.2
	25 + 25 + 25 + 50	1.86	1.86	1.86	3.72	1.7	9.3	9.8	350	1950	3120	9.0	8.6	8.2
	25 + 25 + 25 + 60	1.72	1.72	1.72	4.13	1.7	9.3	9.8	350	1950	3120	9.0	8.6	8.2
	25 + 25 + 35 + 35	1.94	1.94	2.71	2.71	1.7	9.3	9.8	350	1950	3120	9.0	8.6	8.2
	25 + 25 + 35 + 50	1.72	1.72	2.41	3.44	1.7	9.3	9.8	350	1950	3120	9.0	8.6	8.2
	25 + 35 + 35 + 35	1.79	2.50	2.50	2.50	1.7	9.3	9.8	350	1950	3120	9.0	8.6	8.2

COMBINATIONS

Indoor unit combination		Cooling capacity (kW)						Power consumption(W)			Standard current(A)				
		Room cooling capacity				Total capacity		Min.	Standard	Max.	220V	230V	240V		
		A	B	C	D	Min.	Standard							Max.	
Cooling operation	1 room	20	2.00	-	-	-	1.8	2.0	2.8	480	500	950	2.4	2.3	2.2
		25	2.50	-	-	-	1.8	2.5	3.4	480	680	1080	3.2	3.1	3.0
		35	3.50	-	-	-	1.8	3.5	3.9	480	1010	1240	4.7	4.5	4.3
		50	5.00	-	-	-	1.8	5.0	6.1	480	1530	2100	7.0	6.7	6.4
		60	6.00	-	-	-	1.8	6.0	7.0	480	1880	2700	8.6	8.3	7.9
	2 room	20 + 20	2.00	2.00	-	-	3.0	4.0	6.1	550	840	1910	4.0	3.8	3.6
		20 + 25	2.00	2.50	-	-	3.0	4.5	6.4	550	990	2060	4.6	4.4	4.3
		20 + 35	2.00	3.50	-	-	3.0	5.5	6.9	550	1320	2320	6.1	5.8	5.6
		20 + 50	2.03	5.07	-	-	3.0	7.1	8.5	550	1970	2830	9.0	8.7	8.3
		20 + 60	2.00	6.00	-	-	3.0	8.0	8.5	550	2420	2830	11.1	10.6	10.2
		25 + 25	2.50	2.50	-	-	3.0	5.0	6.8	550	1150	2270	5.4	5.1	4.9
		25 + 35	2.46	3.44	-	-	3.0	5.9	7.2	550	1560	2470	7.2	6.9	6.6
		25 + 50	2.47	4.93	-	-	3.0	7.4	8.5	550	2090	2830	9.6	9.2	8.8
		25 + 60	2.35	5.65	-	-	3.0	8.0	8.5	550	2420	2830	11.1	10.6	10.2
		35 + 35	3.55	3.55	-	-	3.0	7.1	8.5	550	1970	2830	9.0	8.7	8.3
35 + 50		3.29	4.71	-	-	3.0	8.0	8.5	550	2420	2830	11.1	10.6	10.2	
35 + 60		2.95	5.05	-	-	3.0	8.0	8.5	550	2420	2830	11.1	10.6	10.2	
50 + 50		4.00	4.00	-	-	3.0	8.0	8.5	550	2420	2830	11.1	10.6	10.2	
50 + 60		3.64	4.36	-	-	3.0	8.0	8.5	550	2420	2830	11.1	10.6	10.2	
60 + 60		4.00	4.00	-	-	3.0	8.0	8.5	550	2420	2830	11.1	10.6	10.2	
3 room	20 + 20 + 20	2.00	2.00	2.00	-	3.7	6.0	8.8	670	1240	2830	5.8	5.5	5.3	
	20 + 20 + 25	2.00	2.00	2.50	-	3.7	6.5	8.8	670	1390	2830	6.4	6.1	5.9	
	20 + 20 + 35	1.89	1.89	3.31	-	3.7	7.1	8.8	670	1520	2830	7.0	6.7	6.4	
	20 + 20 + 50	1.78	1.78	4.44	-	3.7	8.0	8.8	670	1910	2830	8.8	8.4	8.0	
	20 + 20 + 60	1.60	1.60	4.80	-	3.7	8.0	8.8	670	1910	2830	8.8	8.4	8.0	
	20 + 25 + 25	2.03	2.54	2.54	-	3.7	7.1	8.8	670	1520	2830	7.0	6.7	6.4	
	20 + 25 + 35	2.00	2.50	3.50	-	3.7	8.0	8.8	670	1910	2830	8.8	8.4	8.0	
	20 + 25 + 50	1.68	2.11	4.21	-	3.7	8.0	8.8	670	1910	2830	8.8	8.4	8.0	
	20 + 25 + 60	1.52	1.90	4.57	-	3.7	8.0	8.8	670	1910	2830	8.8	8.4	8.0	
	20 + 35 + 35	1.78	3.11	3.11	-	3.7	8.0	8.8	670	1910	2830	8.8	8.4	8.0	
	20 + 35 + 50	1.52	2.67	3.81	-	3.7	8.0	8.8	670	1910	2830	8.8	8.4	8.0	
	20 + 35 + 60	1.39	2.43	4.17	-	3.7	8.0	8.8	670	1910	2830	8.8	8.4	8.0	
	20 + 50 + 50	1.33	3.33	3.33	-	3.7	8.0	8.8	670	1910	2830	8.8	8.4	8.0	
	20 + 50 + 60	1.23	3.08	3.69	-	3.7	8.0	8.8	670	1910	2830	8.8	8.4	8.0	
	25 + 25 + 25	2.37	2.37	2.37	-	3.7	7.1	8.8	670	1520	2830	7.0	6.7	6.4	
	25 + 25 + 35	2.35	2.35	3.29	-	3.7	8.0	8.8	670	1910	2830	8.8	8.4	8.0	
	25 + 25 + 50	2.00	2.00	4.00	-	3.7	8.0	8.8	670	1910	2830	8.8	8.4	8.0	
	25 + 25 + 60	1.82	1.82	4.36	-	3.7	8.0	8.8	670	1910	2830	8.8	8.4	8.0	
	25 + 35 + 35	2.11	2.95	2.95	-	3.7	8.0	8.8	670	1910	2830	8.8	8.4	8.0	
	25 + 35 + 50	1.82	2.55	3.64	-	3.7	8.0	8.8	670	1910	2830	8.8	8.4	8.0	
	25 + 35 + 60	1.67	2.33	4.00	-	3.7	8.0	8.8	670	1910	2830	8.8	8.4	8.0	
	25 + 50 + 50	1.60	3.20	3.20	-	3.7	8.0	8.8	670	1910	2830	8.8	8.4	8.0	
	25 + 50 + 60	1.48	2.96	3.56	-	3.7	8.0	8.8	670	1910	2830	8.8	8.4	8.0	
	35 + 35 + 35	2.67	2.67	2.67	-	3.7	8.0	8.8	670	1910	2830	8.8	8.4	8.0	
	35 + 35 + 50	2.33	2.33	3.33	-	3.7	8.0	8.8	670	1910	2830	8.8	8.4	8.0	
35 + 35 + 60	2.15	2.15	3.69	-	3.7	8.0	8.8	670	1910	2830	8.8	8.4	8.0		
35 + 50 + 50	2.07	2.96	2.96	-	3.7	8.0	8.8	670	1910	2830	8.8	8.4	8.0		
4 room	20 + 20 + 20 + 20	2.00	2.00	2.00	2.00	4.4	8.0	9.2	890	1700	2830	7.8	7.5	7.2	
	20 + 20 + 20 + 25	1.88	1.88	1.88	2.35	4.4	8.0	9.2	890	1700	2830	7.8	7.5	7.2	
	20 + 20 + 20 + 35	1.68	1.68	1.68	2.95	4.4	8.0	9.2	890	1700	2830	7.8	7.5	7.2	
	20 + 20 + 20 + 50	1.45	1.45	1.45	3.64	4.4	8.0	9.2	890	1700	2830	7.8	7.5	7.2	
	20 + 20 + 20 + 60	1.33	1.33	1.33	4.00	4.4	8.0	9.2	890	1700	2830	7.8	7.5	7.2	
	20 + 20 + 25 + 25	1.78	1.78	2.22	2.22	4.4	8.0	9.2	890	1700	2830	7.8	7.5	7.2	
	20 + 20 + 25 + 35	1.60	1.60	2.00	2.80	4.4	8.0	9.2	890	1700	2830	7.8	7.5	7.2	
	20 + 20 + 25 + 50	1.39	1.39	1.74	3.48	4.4	8.0	9.2	890	1700	2830	7.8	7.5	7.2	
	20 + 20 + 25 + 60	1.28	1.28	1.60	3.84	4.4	8.0	9.2	890	1700	2830	7.8	7.5	7.2	
	20 + 20 + 35 + 35	1.45	1.45	2.55	2.55	4.4	8.0	9.2	890	1700	2830	7.8	7.5	7.2	
	20 + 20 + 35 + 50	1.28	1.28	2.24	3.20	4.4	8.0	9.2	890	1700	2830	7.8	7.5	7.2	
	20 + 20 + 35 + 60	1.19	1.19	2.07	3.56	4.4	8.0	9.2	890	1700	2830	7.8	7.5	7.2	
	20 + 25 + 25 + 25	1.68	2.11	2.11	2.11	4.4	8.0	9.2	890	1700	2830	7.8	7.5	7.2	
	20 + 25 + 25 + 35	1.52	1.90	1.90	2.67	4.4	8.0	9.2	890	1700	2830	7.8	7.5	7.2	
	20 + 25 + 25 + 50	1.33	1.67	1.67	3.33	4.4	8.0	9.2	890	1700	2830	7.8	7.5	7.2	
	20 + 25 + 25 + 60	1.23	1.54	1.54	3.69	4.4	8.0	9.2	890	1700	2830	7.8	7.5	7.2	
	20 + 25 + 35 + 35	1.39	1.74	2.43	2.43	4.4	8.0	9.2	890	1700	2830	7.8	7.5	7.2	
	20 + 25 + 35 + 50	1.23	1.54	2.15	3.08	4.4	8.0	9.2	890	1700	2830	7.8	7.5	7.2	
	20 + 35 + 35 + 35	1.28	2.24	2.24	2.24	4.4	8.0	9.2	890	1700	2830	7.8	7.5	7.2	
	25 + 25 + 25 + 25	2.00	2.00	2.00	2.00	4.4	8.0	9.2	890	1700	2830	7.8	7.5	7.2	
	25 + 25 + 25 + 35	1.82	1.82	1.82	2.55	4.4	8.0	9.2	890	1700	2830	7.8	7.5	7.2	
	25 + 25 + 25 + 50	1.60	1.60	1.60	3.20	4.4	8.0	9.2	890	1700	2830	7.8	7.5	7.2	
	25 + 25 + 25 + 60	1.48	1.48	1.48	3.56	4.4	8.0	9.2	890	1700	2830	7.8	7.5	7.2	
	25 + 25 + 35 + 35	1.67	1.67	2.33	2.33	4.4	8.0	9.2	890	1700	2830	7.8	7.5	7.2	
	25 + 25 + 35 + 50	1.48	1.48	2.07	2.96	4.4	8.0	9.2	890	1700	2830	7.8	7.5	7.2	
25 + 35 + 35 + 35	1.54	2.15	2.15	2.15	4.4	8.0	9.2	890	1700	2830	7.8	7.5	7.2		



MULTI-SPLIT SYSTEM

SCM80ZS-W Table of Indoor unit combination with other indoor unit

Indoor unit combination		Heating capacity (kW)						Power consumption(W)			Standard current(A)			
		Room heating capacity				Total capacity		Min.	Standard	Max.	220V	230V	240V	
		A	B	C	D	Min.	Standard							Max.
1 room	20	3.00	-	-	-	1.1	3.0	3.5	390	1060	1330	5.0	4.8	4.6
	25	3.40	-	-	-	1.1	3.4	4.0	390	1220	1510	5.7	5.5	5.2
	35	4.50	-	-	-	1.1	4.5	4.8	390	1510	1790	7.0	6.7	6.4
	50	5.80	-	-	-	1.1	5.8	6.2	390	1950	2310	9.0	8.7	8.3
	60	6.80	-	-	-	1.1	6.8	7.1	390	2240	2660	10.4	9.9	9.5
	71	8.00	-	-	-	1.1	8.0	8.1	390	2740	3120	12.7	12.2	11.6
2 room	20 + 20	2.70	2.70	-	-	1.5	5.4	7.0	350	1370	1870	6.4	6.1	5.9
	20 + 25	2.62	3.28	-	-	1.5	5.9	7.3	350	1560	2130	7.3	6.9	6.7
	20 + 35	2.51	4.39	-	-	1.5	6.9	7.9	350	1930	2650	9.0	8.6	8.2
	20 + 50	2.46	6.14	-	-	1.5	8.6	9.4	350	2460	3120	11.4	10.9	10.5
	20 + 60	2.33	6.98	-	-	1.5	9.3	9.4	350	2650	3120	12.3	11.8	11.3
	20 + 71	2.04	7.26	-	-	1.5	9.3	9.4	350	2650	3120	12.3	11.8	11.3
	25 + 25	3.20	3.20	-	-	1.5	6.4	7.7	350	1740	2480	8.1	7.7	7.4
	25 + 35	3.08	4.32	-	-	1.5	7.4	8.2	350	2130	2910	9.9	9.4	9.1
	25 + 50	2.87	5.73	-	-	1.5	8.6	9.4	350	2460	3120	11.4	10.9	10.5
	25 + 60	2.74	6.56	-	-	1.5	9.3	9.4	350	2650	3120	12.3	11.8	11.3
	25 + 71	2.42	6.88	-	-	1.5	9.3	9.4	350	2650	3120	12.3	11.8	11.3
	35 + 35	4.30	4.30	-	-	1.5	8.6	9.4	350	2460	3120	11.4	10.9	10.5
	35 + 50	3.83	5.47	-	-	1.5	9.3	9.4	350	2650	3120	12.3	11.8	11.3
	35 + 60	3.43	5.87	-	-	1.5	9.3	9.4	350	2650	3120	12.3	11.8	11.3
	35 + 71	3.07	6.23	-	-	1.5	9.3	9.4	350	2650	3120	12.3	11.8	11.3
	50 + 50	4.65	4.65	-	-	1.5	9.3	9.4	350	2650	3120	12.3	11.8	11.3
	50 + 60	4.23	5.07	-	-	1.5	9.3	9.4	350	2650	3120	12.3	11.8	11.3
	50 + 71	3.84	5.46	-	-	1.5	9.3	9.4	350	2650	3120	12.3	11.8	11.3
	60 + 60	4.65	4.65	-	-	1.5	9.3	9.4	350	2650	3120	12.3	11.8	11.3
	60 + 71	4.26	5.04	-	-	1.5	9.3	9.4	350	2650	3120	12.3	11.8	11.3
	3 room	20 + 20 + 20	2.57	2.57	2.57	-	1.6	7.7	9.5	370	1870	3120	8.7	8.3
20 + 20 + 25		2.46	2.46	3.08	-	1.6	8.0	9.5	370	1970	3120	9.1	8.7	8.4
20 + 20 + 35		2.29	2.29	4.01	-	1.6	8.6	9.5	370	2410	3120	11.2	10.7	10.2
20 + 20 + 50		2.07	2.07	5.17	-	1.6	9.3	9.5	370	2600	3120	12.1	11.5	11.1
20 + 20 + 60		1.86	1.86	5.58	-	1.6	9.3	9.5	370	2600	3120	12.1	11.5	11.1
20 + 20 + 71		1.68	1.68	5.95	-	1.6	9.3	9.5	370	2600	3120	12.1	11.5	11.1
20 + 25 + 25		2.46	3.07	3.07	-	1.6	8.6	9.5	370	2410	3120	11.2	10.7	10.2
20 + 25 + 35		2.33	2.91	4.07	-	1.6	9.3	9.5	370	2600	3120	12.1	11.5	11.1
20 + 25 + 50		1.96	2.45	4.89	-	1.6	9.3	9.5	370	2600	3120	12.1	11.5	11.1
20 + 25 + 60		1.77	2.21	5.31	-	1.6	9.3	9.5	370	2600	3120	12.1	11.5	11.1
20 + 25 + 71		1.60	2.00	5.69	-	1.6	9.3	9.5	370	2600	3120	12.1	11.5	11.1
20 + 35 + 35		2.07	3.62	3.62	-	1.6	9.3	9.5	370	2600	3120	12.1	11.5	11.1
20 + 35 + 50		1.77	3.10	4.43	-	1.6	9.3	9.5	370	2600	3120	12.1	11.5	11.1
20 + 35 + 60		1.62	2.83	4.85	-	1.6	9.3	9.5	370	2600	3120	12.1	11.5	11.1
20 + 35 + 71		1.48	2.58	5.24	-	1.6	9.3	9.5	370	2600	3120	12.1	11.5	11.1
20 + 50 + 50		1.55	3.88	3.88	-	1.6	9.3	9.5	370	2600	3120	12.1	11.5	11.1
20 + 50 + 60		1.43	3.58	4.29	-	1.6	9.3	9.5	370	2600	3120	12.1	11.5	11.1
25 + 25 + 25		2.87	2.87	2.87	-	1.6	8.6	9.5	370	2410	3120	11.2	10.7	10.2
25 + 25 + 35		2.74	2.74	3.83	-	1.6	9.3	9.5	370	2600	3120	12.1	11.5	11.1
25 + 25 + 50		2.33	2.33	4.65	-	1.6	9.3	9.5	370	2600	3120	12.1	11.5	11.1
25 + 25 + 60		2.11	2.11	5.07	-	1.6	9.3	9.5	370	2600	3120	12.1	11.5	11.1
25 + 25 + 71		1.92	1.92	5.46	-	1.6	9.3	9.5	370	2600	3120	12.1	11.5	11.1
25 + 35 + 35		2.45	3.43	3.43	-	1.6	9.3	9.5	370	2600	3120	12.1	11.5	11.1
25 + 35 + 50		2.11	2.96	4.23	-	1.6	9.3	9.5	370	2600	3120	12.1	11.5	11.1
25 + 35 + 60		1.94	2.71	4.65	-	1.6	9.3	9.5	370	2600	3120	12.1	11.5	11.1
25 + 35 + 71		1.77	2.48	5.04	-	1.6	9.3	9.5	370	2600	3120	12.1	11.5	11.1
25 + 50 + 50		1.86	3.72	3.72	-	1.6	9.3	9.5	370	2600	3120	12.1	11.5	11.1
25 + 50 + 60		1.72	3.44	4.13	-	1.6	9.3	9.5	370	2600	3120	12.1	11.5	11.1
35 + 35 + 35		3.10	3.10	3.10	-	1.6	9.3	9.5	370	2600	3120	12.1	11.5	11.1
35 + 35 + 50		2.71	2.71	3.88	-	1.6	9.3	9.5	370	2600	3120	12.1	11.5	11.1
35 + 35 + 60		2.50	2.50	4.29	-	1.6	9.3	9.5	370	2600	3120	12.1	11.5	11.1
35 + 50 + 50		2.41	3.44	3.44	-	1.6	9.3	9.5	370	2600	3120	12.1	11.5	11.1
4 room		20 + 20 + 20 + 20	2.33	2.33	2.33	2.33	1.7	9.3	9.6	350	2170	3120	10.1	9.6
	20 + 20 + 20 + 25	2.19	2.19	2.19	2.74	1.7	9.3	9.6	350	2170	3120	10.1	9.6	9.2
	20 + 20 + 20 + 35	1.96	1.96	1.96	3.43	1.7	9.3	9.6	350	2170	3120	10.1	9.6	9.2
	20 + 20 + 20 + 50	1.69	1.69	1.69	4.23	1.7	9.3	9.6	350	2170	3120	10.1	9.6	9.2
	20 + 20 + 20 + 60	1.55	1.55	1.55	4.65	1.7	9.3	9.6	350	2170	3120	10.1	9.6	9.2
	20 + 20 + 25 + 25	2.07	2.07	2.58	2.58	1.7	9.3	9.6	350	2170	3120	10.1	9.6	9.2
	20 + 20 + 25 + 35	1.86	1.86	2.33	3.26	1.7	9.3	9.6	350	2170	3120	10.1	9.6	9.2
	20 + 20 + 25 + 50	1.62	1.62	2.02	4.04	1.7	9.3	9.6	350	2170	3120	10.1	9.6	9.2
	20 + 20 + 25 + 60	1.49	1.49	1.86	4.46	1.7	9.3	9.6	350	2170	3120	10.1	9.6	9.2
	20 + 20 + 35 + 35	1.69	1.69	2.96	2.96	1.7	9.3	9.6	350	2170	3120	10.1	9.6	9.2
	20 + 20 + 35 + 50	1.49	1.49	2.60	3.72	1.7	9.3	9.6	350	2170	3120	10.1	9.6	9.2
	20 + 20 + 35 + 60	1.38	1.38	2.41	4.13	1.7	9.3	9.6	350	2170	3120	10.1	9.6	9.2
	20 + 25 + 25 + 25	1.96	2.45	2.45	2.45	1.7	9.3	9.6	350	2170	3120	10.1	9.6	9.2
	20 + 25 + 25 + 35	1.77	2.21	2.21	3.10	1.7	9.3	9.6	350	2170	3120	10.1	9.6	9.2
	20 + 25 + 25 + 50	1.55	1.94	1.94	3.88	1.7	9.3	9.6	350	2170	3120	10.1	9.6	9.2
	20 + 25 + 25 + 60	1.43	1.79	1.79	4.29	1.7	9.3	9.6	350	2170	3120	10.1	9.6	9.2
	20 + 25 + 35 + 35	1.62	2.02	2.83	2.83	1.7	9.3	9.6	350	2170	3120	10.1	9.6	9.2
	20 + 25 + 35 + 50	1.43	1.79	2.50	3.58	1.7	9.3	9.6	350	2170	3120	10.1	9.6	9.2
	20 + 35 + 35 + 35	1.49	2.60	2.60	2.60	1.7	9.3	9.6	350	2170	3120	10.1	9.6	9.2
	25 + 25 + 25 + 25	2.33	2.33	2.33	2.33	1.7	9.3	9.6	350	2170	3120	10.1	9.6	9.2
	25 + 25 + 25 + 35	2.11	2.11	2.11	2.96	1.7	9.3	9.6	350	2170	3120	10.1	9.6	9.2
	25 + 25 + 25 + 50	1.86	1.86	1.86	3.72	1.7	9.3	9.6	350	2170	3120	10.1	9.6	9.2
	25 + 25 + 25 + 60	1.72	1.72	1.72	4.13	1.7	9.3	9.6	350	2170	3120	10.1	9.6	9.2
	25 + 25 + 35 + 35	1.94	1.94	2.71	2.71	1.7	9.3	9.6	350	2170	3120	10.1	9.6	9.2
	25 + 25 + 35 + 50	1.72	1.72	2.41	3.44	1.7	9.3	9.6	350	2170	3120	10.1	9.6	9.2
	25 + 35 + 35 + 35	1.79	2.50	2.50	2.50	1.7	9.3	9.6	350	2170	3120	10.1	9.6	9.2

COMBINATIONS

Indoor unit combination		Cooling capacity (kW)							Power consumption(W)			Standard current(A)		
		Room cooling capacity				Total capacity			Min.	Standard	Max.	220V	230V	240V
		A	B	C	D	Min.	Standard	Max.						
1 room	20	2.00	-	-	-	1.8	2.0	2.7	480	530	950	2.5	2.4	2.3
	25	2.50	-	-	-	1.8	2.5	3.2	480	730	1080	3.5	3.3	3.2
	35	3.50	-	-	-	1.8	3.5	3.7	480	1120	1240	5.2	5.0	4.8
	50	5.00	-	-	-	1.8	5.0	5.8	480	1710	2100	7.9	7.5	7.2
	60	6.00	-	-	-	1.8	6.0	6.7	480	2140	2700	9.8	9.4	9.0
2 room	71	7.10	-	-	-	1.8	7.1	7.2	480	2430	2830	11.2	10.7	10.2
	20 + 20	2.00	2.00	-	-	3.0	4.0	5.8	550	930	1910	4.4	4.2	4.0
	20 + 25	2.00	2.50	-	-	3.0	4.5	6.1	550	1170	2060	5.5	5.2	5.0
	20 + 35	2.00	3.50	-	-	3.0	5.5	6.6	550	1590	2320	7.3	7.0	6.7
	20 + 50	2.03	5.07	-	-	3.0	7.1	8.3	550	2340	2830	10.7	10.3	9.8
	20 + 60	2.00	6.00	-	-	3.0	8.0	8.3	550	2720	2830	12.5	11.9	11.4
	20 + 71	1.76	6.24	-	-	3.0	8.0	8.3	550	2720	2830	12.5	11.9	11.4
	25 + 25	2.50	2.50	-	-	3.0	5.0	6.5	550	1360	2270	6.3	6.0	5.8
	25 + 35	2.46	3.44	-	-	3.0	5.9	6.8	550	1780	2470	8.2	7.8	7.5
	25 + 50	2.47	4.93	-	-	3.0	7.4	8.3	550	2430	2830	11.2	10.7	10.2
	25 + 60	2.35	5.65	-	-	3.0	8.0	8.3	550	2720	2830	12.5	11.9	11.4
	25 + 71	2.08	5.92	-	-	3.0	8.0	8.3	550	2720	2830	12.5	11.9	11.4
	35 + 35	3.55	3.55	-	-	3.0	7.1	8.3	550	2340	2830	10.7	10.3	9.8
	35 + 50	3.29	4.71	-	-	3.0	8.0	8.3	550	2720	2830	12.5	11.9	11.4
	35 + 60	2.95	5.05	-	-	3.0	8.0	8.3	550	2720	2830	12.5	11.9	11.4
	35 + 71	2.64	5.36	-	-	3.0	8.0	8.3	550	2720	2830	12.5	11.9	11.4
	50 + 50	4.00	4.00	-	-	3.0	8.0	8.3	550	2720	2830	12.5	11.9	11.4
	50 + 60	3.64	4.36	-	-	3.0	8.0	8.3	550	2720	2830	12.5	11.9	11.4
	50 + 71	3.31	4.69	-	-	3.0	8.0	8.3	550	2720	2830	12.5	11.9	11.4
	60 + 60	4.00	4.00	-	-	3.0	8.0	8.3	550	2720	2830	12.5	11.9	11.4
	60 + 71	3.66	4.34	-	-	3.0	8.0	8.3	550	2720	2830	12.5	11.9	11.4
	3 room	20 + 20 + 20	2.00	2.00	2.00	-	3.7	6.0	8.5	670	1440	2830	6.6	6.4
20 + 20 + 25		2.00	2.00	2.50	-	3.7	6.5	8.5	670	1630	2830	7.5	7.2	6.9
20 + 20 + 35		1.89	1.89	3.31	-	3.7	7.1	8.5	670	1870	2830	8.6	8.2	7.9
20 + 20 + 50		1.78	1.78	4.44	-	3.7	8.0	8.5	670	2290	2830	10.5	10.1	9.6
20 + 20 + 60		1.60	1.60	4.80	-	3.7	8.0	8.5	670	2290	2830	10.5	10.1	9.6
20 + 20 + 71		1.44	1.44	5.12	-	3.7	8.0	8.5	670	2290	2830	10.5	10.1	9.6
20 + 25 + 25		2.03	2.54	2.54	-	3.7	7.1	8.5	670	1870	2830	8.6	8.2	7.9
20 + 25 + 35		2.00	2.50	3.50	-	3.7	8.0	8.5	670	2290	2830	10.5	10.1	9.6
20 + 25 + 50		1.68	2.11	4.21	-	3.7	8.0	8.5	670	2290	2830	10.5	10.1	9.6
20 + 25 + 60		1.52	1.90	4.57	-	3.7	8.0	8.5	670	2290	2830	10.5	10.1	9.6
20 + 25 + 71		1.38	1.72	4.90	-	3.7	8.0	8.5	670	2290	2830	10.5	10.1	9.6
20 + 35 + 35		1.78	3.11	3.11	-	3.7	8.0	8.5	670	2290	2830	10.5	10.1	9.6
20 + 35 + 50		1.52	2.67	3.81	-	3.7	8.0	8.5	670	2290	2830	10.5	10.1	9.6
20 + 35 + 60		1.39	2.43	4.17	-	3.7	8.0	8.5	670	2290	2830	10.5	10.1	9.6
20 + 35 + 71		1.27	2.22	4.51	-	3.7	8.0	8.5	670	2290	2830	10.5	10.1	9.6
20 + 50 + 50		1.33	3.33	3.33	-	3.7	8.0	8.5	670	2290	2830	10.5	10.1	9.6
20 + 50 + 60		1.23	3.08	3.69	-	3.7	8.0	8.5	670	2290	2830	10.5	10.1	9.6
25 + 25 + 25		2.37	2.37	2.37	-	3.7	7.1	8.5	670	1870	2830	8.6	8.2	7.9
25 + 25 + 35		2.35	2.35	3.29	-	3.7	8.0	8.5	670	2290	2830	10.5	10.1	9.6
25 + 25 + 50		2.00	2.00	4.00	-	3.7	8.0	8.5	670	2290	2830	10.5	10.1	9.6
25 + 25 + 60		1.82	1.82	4.36	-	3.7	8.0	8.5	670	2290	2830	10.5	10.1	9.6
25 + 25 + 71		1.65	1.65	4.69	-	3.7	8.0	8.5	670	2290	2830	10.5	10.1	9.6
25 + 35 + 35		2.11	2.95	2.95	-	3.7	8.0	8.5	670	2290	2830	10.5	10.1	9.6
25 + 35 + 50		1.82	2.55	3.64	-	3.7	8.0	8.5	670	2290	2830	10.5	10.1	9.6
25 + 35 + 60		1.67	2.33	4.00	-	3.7	8.0	8.5	670	2290	2830	10.5	10.1	9.6
25 + 35 + 71		1.53	2.14	4.34	-	3.7	8.0	8.5	670	2290	2830	10.5	10.1	9.6
25 + 50 + 50		1.60	3.20	3.20	-	3.7	8.0	8.5	670	2290	2830	10.5	10.1	9.6
25 + 50 + 60		1.48	2.96	3.56	-	3.7	8.0	8.5	670	2290	2830	10.5	10.1	9.6
35 + 35 + 35		2.67	2.67	2.67	-	3.7	8.0	8.5	670	2290	2830	10.5	10.1	9.6
35 + 35 + 50		2.33	3.33	3.33	-	3.7	8.0	8.5	670	2290	2830	10.5	10.1	9.6
35 + 35 + 60		2.15	2.15	3.69	-	3.7	8.0	8.5	670	2290	2830	10.5	10.1	9.6
35 + 50 + 50		2.07	2.96	2.96	-	3.7	8.0	8.5	670	2290	2830	10.5	10.1	9.6
4 room		20 + 20 + 20 + 20	2.00	2.00	2.00	2.00	4.4	8.0	8.7	890	2170	2830	10.0	9.5
	20 + 20 + 20 + 25	1.88	1.88	1.88	2.35	4.4	8.0	8.7	890	2170	2830	10.0	9.5	9.1
	20 + 20 + 20 + 35	1.68	1.68	1.68	2.95	4.4	8.0	8.7	890	2170	2830	10.0	9.5	9.1
	20 + 20 + 20 + 50	1.45	1.45	1.45	3.64	4.4	8.0	8.7	890	2170	2830	10.0	9.5	9.1
	20 + 20 + 20 + 60	1.33	1.33	1.33	4.00	4.4	8.0	8.7	890	2170	2830	10.0	9.5	9.1
	20 + 20 + 25 + 25	1.78	1.78	2.22	2.22	4.4	8.0	8.7	890	2170	2830	10.0	9.5	9.1
	20 + 20 + 25 + 35	1.60	1.60	2.00	2.80	4.4	8.0	8.7	890	2170	2830	10.0	9.5	9.1
	20 + 20 + 25 + 50	1.39	1.39	1.74	3.48	4.4	8.0	8.7	890	2170	2830	10.0	9.5	9.1
	20 + 20 + 25 + 60	1.28	1.28	1.60	3.84	4.4	8.0	8.7	890	2170	2830	10.0	9.5	9.1
	20 + 20 + 35 + 35	1.45	1.45	2.55	2.55	4.4	8.0	8.7	890	2170	2830	10.0	9.5	9.1
	20 + 20 + 35 + 50	1.28	1.28	2.24	3.20	4.4	8.0	8.7	890	2170	2830	10.0	9.5	9.1
	20 + 20 + 35 + 60	1.19	1.19	2.07	3.56	4.4	8.0	8.7	890	2170	2830	10.0	9.5	9.1
	20 + 25 + 25 + 25	1.68	2.11	2.11	2.11	4.4	8.0	8.7	890	2170	2830	10.0	9.5	9.1
	20 + 25 + 25 + 35	1.52	1.90	1.90	2.67	4.4	8.0	8.7	890	2170	2830	10.0	9.5	9.1
	20 + 25 + 25 + 50	1.33	1.67	1.67	3.33	4.4	8.0	8.7	890	2170	2830	10.0	9.5	9.1
	20 + 25 + 25 + 60	1.23	1.54	1.54	3.69	4.4	8.0	8.7	890	2170	2830	10.0	9.5	9.1
	20 + 25 + 35 + 35	1.39	1.74	2.43	2.43	4.4	8.0	8.7	890	2170	2830	10.0	9.5	9.1
	20 + 25 + 35 + 50	1.23	1.54	2.15	3.08	4.4	8.0	8.7	890	2170	2830	10.0	9.5	9.1
	20 + 35 + 35 + 35	1.28	2.24	2.24	2.24	4.4	8.0	8.7	890	2170	2830	10.0	9.5	9.1
	25 + 25 + 25 + 25	2.00	2.00	2.00	2.00	4.4	8.0	8.7	890	2170	2830	10.0	9.5	9.1
	25 + 25 + 25 + 35	1.82	1.82	1.82	2.55	4.4	8.0	8.7	890	2170	2830	10.0	9.5	9.1
	25 + 25 + 25 + 50	1.60	1.60	1.60	3.20	4.4	8.0	8.7	890	2170	2830	10.0	9.5	9.1
	25 + 25 + 25 + 60	1.48	1.48	1.48	3.56	4.4	8.0	8.7	890	2170	2830	10.0	9.5	9.1
	25 + 25 + 35 + 35	1.67	1.67	2.33	2.33	4.4	8.0	8.7	890	2170	2830	10.0	9.5	9.1
	25 + 25 + 35 + 50	1.48	1.48	2.07	2.96	4.4	8.0	8.7	890	2170	2830	10.0	9.5	9.1
25 + 35 + 35 + 35	1.54	2.15	2.15	2.15	4.4	8.0	8.7	890	2170	2830	10.0	9.5	9.1	



MULTI-SPLIT SYSTEM

SCM100ZS-W Table of Indoor unit combination with all indoor unit

Indoor unit combination	Heating capacity (kW)								Power consumption(W)			Standard current(A)		
	Room heating capacity					Total capacity			Min.	Standard	Max.	220V	230V	240V
	A	B	C	D	E	Min.	Standard	Max.						
1 room	20	3.00	-	-	-	0.9	3.0	3.5	490	1060	1330	5.1	4.8	4.6
	25	3.40	-	-	-	0.9	3.4	4.0	490	1140	1400	5.4	5.2	5.0
	35	4.50	-	-	-	0.9	4.5	4.8	490	1350	1570	6.3	6.1	5.8
	50	5.80	-	-	-	0.9	5.8	6.2	490	1610	1770	7.4	7.1	6.8
	60	6.80	-	-	-	0.9	6.8	7.1	490	1800	1920	8.3	7.9	7.6
	71	8.00	-	-	-	0.9	8.0	8.1	490	2030	2110	9.3	8.9	8.5
	80	9.00	-	-	-	0.9	9.0	9.1	490	2220	2260	10.2	9.7	9.3
2 room	20 + 20	2.70	2.70	-	-	1.2	5.4	7.0	460	1170	1610	5.5	5.2	5.0
	20 + 25	2.62	3.28	-	-	1.2	5.9	7.3	460	1310	1690	6.0	5.8	5.5
	20 + 35	2.51	4.39	-	-	1.2	6.9	7.9	460	1580	1860	7.3	6.9	6.6
	20 + 50	2.51	6.29	-	-	1.2	8.8	9.2	460	2130	2240	9.8	9.4	9.0
	20 + 60	2.45	7.35	-	-	1.2	9.8	10.3	460	2430	2580	11.2	10.7	10.2
	20 + 71	2.31	8.19	-	-	1.2	10.5	11.2	460	2620	2900	12.0	11.5	11.0
	20 + 80	2.10	8.40	-	-	1.2	10.5	11.2	460	2620	2900	12.0	11.5	11.0
	25 + 25	3.20	3.20	-	-	1.2	6.4	7.7	460	1440	1810	6.6	6.3	6.1
	25 + 35	3.25	4.55	-	-	1.2	7.8	8.2	460	1830	1950	8.4	8.0	7.7
	25 + 50	3.07	6.13	-	-	1.2	9.2	9.6	460	2240	2370	10.3	9.8	9.4
	25 + 60	3.00	7.20	-	-	1.2	10.2	10.7	460	2550	2710	11.7	11.2	10.7
	25 + 71	2.73	7.77	-	-	1.2	10.5	11.2	460	2620	2900	12.0	11.5	11.0
	25 + 80	2.50	8.00	-	-	1.2	10.5	11.2	460	2620	2900	12.0	11.5	11.0
	35 + 35	4.50	4.50	-	-	1.2	9.0	9.4	460	2180	2310	10.0	9.6	9.2
	35 + 50	4.24	6.06	-	-	1.2	10.3	10.8	460	2560	2740	11.8	11.2	10.8
	35 + 60	3.87	6.63	-	-	1.2	10.5	11.2	460	2620	2900	12.0	11.5	11.0
	35 + 71	3.47	7.03	-	-	1.2	10.5	11.2	460	2620	2900	12.0	11.5	11.0
	35 + 80	3.20	7.30	-	-	1.2	10.5	11.2	460	2620	2900	12.0	11.5	11.0
	50 + 50	5.25	5.25	-	-	1.2	10.5	11.2	460	2620	2900	12.0	11.5	11.0
	50 + 60	4.77	5.73	-	-	1.2	10.5	11.2	460	2620	2900	12.0	11.5	11.0
50 + 71	4.34	6.16	-	-	1.2	10.5	11.2	460	2620	2900	12.0	11.5	11.0	
50 + 80	4.04	6.46	-	-	1.2	10.5	11.2	460	2620	2900	12.0	11.5	11.0	
60 + 60	5.25	5.25	-	-	1.2	10.5	11.2	460	2620	2900	12.0	11.5	11.0	
60 + 71	4.81	5.69	-	-	1.2	10.5	11.2	460	2620	2900	12.0	11.5	11.0	
60 + 80	4.50	6.00	-	-	1.2	10.5	11.2	460	2620	2900	12.0	11.5	11.0	
71 + 71	5.25	5.25	-	-	1.2	10.5	11.2	460	2620	2900	12.0	11.5	11.0	
71 + 80	4.94	5.56	-	-	1.2	10.5	11.2	460	2620	2900	12.0	11.5	11.0	
80 + 80	5.25	5.25	-	-	1.2	10.5	11.2	460	2620	2900	12.0	11.5	11.0	
3 room	20 + 20 + 20	3.00	3.00	3.00	-	1.4	9.0	9.6	430	2140	2320	9.8	9.4	9.0
	20 + 20 + 25	2.89	2.89	3.62	-	1.4	9.4	10.0	430	2260	2440	10.4	9.9	9.5
	20 + 20 + 35	2.80	2.80	4.90	-	1.4	10.5	11.3	430	2540	2900	11.7	11.2	10.7
	20 + 20 + 50	2.33	2.33	5.83	-	1.4	10.5	11.3	430	2540	2900	11.7	11.2	10.7
	20 + 20 + 60	2.10	2.10	6.30	-	1.4	10.5	11.3	430	2540	2900	11.7	11.2	10.7
	20 + 20 + 71	1.89	1.89	6.72	-	1.4	10.5	11.3	430	2540	2900	11.7	11.2	10.7
	20 + 20 + 80	1.75	1.75	7.00	-	1.4	10.5	11.3	430	2540	2900	11.7	11.2	10.7
	20 + 25 + 25	3.00	3.75	3.75	-	1.4	10.5	11.3	430	2540	2900	11.7	11.2	10.7
	20 + 25 + 35	2.63	3.28	4.59	-	1.4	10.5	11.3	430	2540	2900	11.7	11.2	10.7
	20 + 25 + 50	2.21	2.76	5.53	-	1.4	10.5	11.3	430	2540	2900	11.7	11.2	10.7
	20 + 25 + 60	2.00	2.50	6.00	-	1.4	10.5	11.3	430	2540	2900	11.7	11.2	10.7
	20 + 35 + 35	2.33	4.08	4.08	-	1.4	10.5	11.3	430	2540	2900	11.7	11.2	10.7
	20 + 35 + 50	2.00	3.50	5.00	-	1.4	10.5	11.3	430	2540	2900	11.7	11.2	10.7
	20 + 35 + 60	1.83	3.20	5.48	-	1.4	10.5	11.3	430	2540	2900	11.7	11.2	10.7
	20 + 35 + 71	1.67	2.92	5.92	-	1.4	10.5	11.3	430	2540	2900	11.7	11.2	10.7
	20 + 35 + 80	1.56	2.72	6.22	-	1.4	10.5	11.3	430	2540	2900	11.7	11.2	10.7
	20 + 50 + 50	1.75	4.38	4.38	-	1.4	10.5	11.3	430	2540	2900	11.7	11.2	10.7
	20 + 50 + 60	1.62	4.04	4.85	-	1.4	10.5	11.3	430	2540	2900	11.7	11.2	10.7
	20 + 50 + 71	1.49	3.72	5.29	-	1.4	10.5	11.3	430	2540	2900	11.7	11.2	10.7
	20 + 50 + 80	1.40	3.50	5.60	-	1.4	10.5	11.3	430	2540	2900	11.7	11.2	10.7
	20 + 60 + 60	1.50	4.50	4.50	-	1.4	10.5	11.3	430	2540	2900	11.7	11.2	10.7
	20 + 60 + 71	1.39	4.17	4.94	-	1.4	10.5	11.3	430	2540	2900	11.7	11.2	10.7
	20 + 60 + 80	1.31	3.94	5.25	-	1.4	10.5	11.3	430	2540	2900	11.7	11.2	10.7
	25 + 25 + 25	3.50	3.50	3.50	-	1.4	10.5	11.3	430	2540	2900	11.7	11.2	10.7
	25 + 25 + 35	3.09	3.09	4.32	-	1.4	10.5	11.3	430	2540	2900	11.7	11.2	10.7
	25 + 25 + 50	2.63	2.63	5.25	-	1.4	10.5	11.3	430	2540	2900	11.7	11.2	10.7
	25 + 25 + 60	2.39	2.39	5.73	-	1.4	10.5	11.3	430	2540	2900	11.7	11.2	10.7
	25 + 25 + 71	2.17	2.17	6.16	-	1.4	10.5	11.3	430	2540	2900	11.7	11.2	10.7
	25 + 25 + 80	2.02	2.02	6.46	-	1.4	10.5	11.3	430	2540	2900	11.7	11.2	10.7
	25 + 35 + 35	2.76	3.87	3.87	-	1.4	10.5	11.3	430	2540	2900	11.7	11.2	10.7
	25 + 35 + 50	2.39	3.34	4.77	-	1.4	10.5	11.3	430	2540	2900	11.7	11.2	10.7
	25 + 35 + 60	2.19	3.06	5.25	-	1.4	10.5	11.3	430	2540	2900	11.7	11.2	10.7
	25 + 35 + 71	2.00	2.81	5.69	-	1.4	10.5	11.3	430	2540	2900	11.7	11.2	10.7
25 + 35 + 80	1.88	2.63	6.00	-	1.4	10.5	11.3	430	2540	2900	11.7	11.2	10.7	
25 + 50 + 50	2.10	4.20	4.20	-	1.4	10.5	11.3	430	2540	2900	11.7	11.2	10.7	
25 + 50 + 60	1.94	3.89	4.67	-	1.4	10.5	11.3	430	2540	2900	11.7	11.2	10.7	
25 + 50 + 71	1.80	3.60	5.11	-	1.4	10.5	11.3	430	2540	2900	11.7	11.2	10.7	
25 + 50 + 80	1.69	3.39	5.42	-	1.4	10.5	11.3	430	2540	2900	11.7	11.2	10.7	
25 + 60 + 60	1.81	4.34	4.34	-	1.4	10.5	11.3	430	2540	2900	11.7	11.2	10.7	
25 + 60 + 71	1.68	4.04	4.78	-	1.4	10.5	11.3	430	2540	2900	11.7	11.2	10.7	

COMBINATIONS

Indoor unit combination		Heating capacity (kW)							Power consumption(W)			Standard current(A)				
		Room heating capacity					Total capacity			Min.	Standard	Max.	220V	230V	240V	
		A	B	C	D	E	Min.	Standard	Max.							
3 room	35 + 35 + 35	3.50	3.50	3.50	-	-	1.4	10.5	11.3	430	2540	2900	11.7	11.2	10.7	
	35 + 35 + 50	3.06	3.06	4.38	-	-	1.4	10.5	11.3	430	2540	2900	11.7	11.2	10.7	
	35 + 35 + 60	2.83	2.83	4.85	-	-	1.4	10.5	11.3	430	2540	2900	11.7	11.2	10.7	
	35 + 35 + 71	2.61	2.61	5.29	-	-	1.4	10.5	11.3	430	2540	2900	11.7	11.2	10.7	
	35 + 35 + 80	2.45	2.45	5.60	-	-	1.4	10.5	11.3	430	2540	2900	11.7	11.2	10.7	
	35 + 50 + 50	2.72	3.89	3.89	-	-	1.4	10.5	11.3	430	2540	2900	11.7	11.2	10.7	
	35 + 50 + 60	2.53	3.62	4.34	-	-	1.4	10.5	11.3	430	2540	2900	11.7	11.2	10.7	
	35 + 50 + 71	2.36	3.37	4.78	-	-	1.4	10.5	11.3	430	2540	2900	11.7	11.2	10.7	
	35 + 60 + 60	2.37	4.06	4.06	-	-	1.4	10.5	11.3	430	2540	2900	11.7	11.2	10.7	
	50 + 50 + 50	3.50	3.50	3.50	-	-	1.4	10.5	11.3	430	2540	2900	11.7	11.2	10.7	
	50 + 50 + 60	3.28	3.28	3.94	-	-	1.4	10.5	11.3	430	2540	2900	11.7	11.2	10.7	
	Heating operation 4 room	20 + 20 + 20 + 20	2.63	2.63	2.63	2.63	-	1.6	10.5	11.4	400	2460	2900	11.3	10.8	10.4
		20 + 20 + 20 + 25	2.47	2.47	2.47	3.09	-	1.6	10.5	11.4	400	2460	2900	11.3	10.8	10.4
		20 + 20 + 20 + 35	2.21	2.21	2.21	3.87	-	1.6	10.5	11.4	400	2460	2900	11.3	10.8	10.4
		20 + 20 + 20 + 50	1.91	1.91	1.91	4.77	-	1.6	10.5	11.4	400	2460	2900	11.3	10.8	10.4
20 + 20 + 20 + 60		1.75	1.75	1.75	5.25	-	1.6	10.5	11.4	400	2460	2900	11.3	10.8	10.4	
20 + 20 + 20 + 71		1.60	1.60	1.60	5.69	-	1.6	10.5	11.4	400	2460	2900	11.3	10.8	10.4	
20 + 20 + 20 + 80		1.50	1.50	1.50	6.00	-	1.6	10.5	11.4	400	2460	2900	11.3	10.8	10.4	
20 + 20 + 25 + 25		2.33	2.33	2.92	2.92	-	1.6	10.5	11.4	400	2460	2900	11.3	10.8	10.4	
20 + 20 + 25 + 35		2.10	2.10	2.63	3.68	-	1.6	10.5	11.4	400	2460	2900	11.3	10.8	10.4	
20 + 20 + 25 + 50		1.83	1.83	2.28	4.57	-	1.6	10.5	11.4	400	2460	2900	11.3	10.8	10.4	
20 + 20 + 25 + 60		1.68	1.68	2.10	5.04	-	1.6	10.5	11.4	400	2460	2900	11.3	10.8	10.4	
20 + 20 + 25 + 71		1.54	1.54	1.93	5.48	-	1.6	10.5	11.4	400	2460	2900	11.3	10.8	10.4	
20 + 20 + 25 + 80		1.45	1.45	1.81	5.79	-	1.6	10.5	11.4	400	2460	2900	11.3	10.8	10.4	
20 + 20 + 35 + 35		1.91	1.91	3.34	3.34	-	1.6	10.5	11.4	400	2460	2900	11.3	10.8	10.4	
20 + 20 + 35 + 50		1.68	1.68	2.94	4.20	-	1.6	10.5	11.4	400	2460	2900	11.3	10.8	10.4	
20 + 20 + 35 + 60		1.56	1.56	2.72	4.67	-	1.6	10.5	11.4	400	2460	2900	11.3	10.8	10.4	
20 + 20 + 35 + 71		1.44	1.44	2.52	5.11	-	1.6	10.5	11.4	400	2460	2900	11.3	10.8	10.4	
20 + 20 + 35 + 80		1.35	1.35	2.37	5.42	-	1.6	10.5	11.4	400	2460	2900	11.3	10.8	10.4	
20 + 20 + 50 + 50		1.50	1.50	3.75	3.75	-	1.6	10.5	11.4	400	2460	2900	11.3	10.8	10.4	
20 + 20 + 50 + 60		1.40	1.40	3.50	4.20	-	1.6	10.5	11.4	400	2460	2900	11.3	10.8	10.4	
20 + 20 + 60 + 60		1.31	1.31	3.94	3.94	-	1.6	10.5	11.4	400	2460	2900	11.3	10.8	10.4	
20 + 25 + 25 + 25		2.21	2.76	2.76	2.76	-	1.6	10.5	11.4	400	2460	2900	11.3	10.8	10.4	
20 + 25 + 25 + 35		2.00	2.50	2.50	3.50	-	1.6	10.5	11.4	400	2460	2900	11.3	10.8	10.4	
20 + 25 + 25 + 50		1.75	2.19	2.19	4.38	-	1.6	10.5	11.4	400	2460	2900	11.3	10.8	10.4	
20 + 25 + 25 + 60		1.62	2.02	2.02	4.85	-	1.6	10.5	11.4	400	2460	2900	11.3	10.8	10.4	
20 + 25 + 25 + 71		1.49	1.86	1.86	5.29	-	1.6	10.5	11.4	400	2460	2900	11.3	10.8	10.4	
20 + 25 + 25 + 80		1.40	1.75	1.75	5.60	-	1.6	10.5	11.4	400	2460	2900	11.3	10.8	10.4	
20 + 25 + 35 + 35		1.83	2.28	3.20	3.20	-	1.6	10.5	11.4	400	2460	2900	11.3	10.8	10.4	
20 + 25 + 35 + 50		1.62	2.02	2.83	4.04	-	1.6	10.5	11.4	400	2460	2900	11.3	10.8	10.4	
20 + 25 + 35 + 60		1.50	1.88	2.63	4.50	-	1.6	10.5	11.4	400	2460	2900	11.3	10.8	10.4	
20 + 25 + 35 + 71		1.39	1.74	2.43	4.94	-	1.6	10.5	11.4	400	2460	2900	11.3	10.8	10.4	
20 + 25 + 35 + 80		1.31	1.64	2.30	5.25	-	1.6	10.5	11.4	400	2460	2900	11.3	10.8	10.4	
20 + 25 + 50 + 50		1.45	1.81	3.62	3.62	-	1.6	10.5	11.4	400	2460	2900	11.3	10.8	10.4	
20 + 25 + 50 + 60		1.35	1.69	3.39	4.06	-	1.6	10.5	11.4	400	2460	2900	11.3	10.8	10.4	
20 + 35 + 35 + 35		1.68	2.94	2.94	2.94	-	1.6	10.5	11.4	400	2460	2900	11.3	10.8	10.4	
20 + 35 + 35 + 50		1.50	2.63	2.63	3.75	-	1.6	10.5	11.4	400	2460	2900	11.3	10.8	10.4	
20 + 35 + 35 + 60		1.40	2.45	2.45	4.20	-	1.6	10.5	11.4	400	2460	2900	11.3	10.8	10.4	
20 + 35 + 50 + 50		1.35	2.37	3.39	3.39	-	1.6	10.5	11.4	400	2460	2900	11.3	10.8	10.4	
25 + 25 + 25 + 25		2.63	2.63	2.63	2.63	-	1.6	10.5	11.4	400	2460	2900	11.3	10.8	10.4	
25 + 25 + 25 + 35		2.39	2.39	2.39	3.34	-	1.6	10.5	11.4	400	2460	2900	11.3	10.8	10.4	
25 + 25 + 25 + 50		2.10	2.10	2.10	4.20	-	1.6	10.5	11.4	400	2460	2900	11.3	10.8	10.4	
25 + 25 + 25 + 60		1.94	1.94	1.94	4.67	-	1.6	10.5	11.4	400	2460	2900	11.3	10.8	10.4	
25 + 25 + 25 + 71		1.80	1.80	1.80	5.11	-	1.6	10.5	11.4	400	2460	2900	11.3	10.8	10.4	
25 + 25 + 25 + 80		1.69	1.69	1.69	5.42	-	1.6	10.5	11.4	400	2460	2900	11.3	10.8	10.4	
25 + 25 + 35 + 35		2.19	2.19	3.06	3.06	-	1.6	10.5	11.4	400	2460	2900	11.3	10.8	10.4	
25 + 25 + 35 + 50		1.94	1.94	2.72	3.89	-	1.6	10.5	11.4	400	2460	2900	11.3	10.8	10.4	
25 + 25 + 35 + 60		1.81	1.81	2.53	4.34	-	1.6	10.5	11.4	400	2460	2900	11.3	10.8	10.4	
25 + 25 + 35 + 71		1.68	1.68	2.36	4.78	-	1.6	10.5	11.4	400	2460	2900	11.3	10.8	10.4	
25 + 25 + 50 + 50		1.75	1.75	3.50	3.50	-	1.6	10.5	11.4	400	2460	2900	11.3	10.8	10.4	
25 + 25 + 50 + 60		1.64	1.64	3.28	3.94	-	1.6	10.5	11.4	400	2460	2900	11.3	10.8	10.4	
25 + 35 + 35 + 35		2.02	2.83	2.83	2.83	-	1.6	10.5	11.4	400	2460	2900	11.3	10.8	10.4	
25 + 35 + 35 + 50		1.81	2.53	2.53	3.62	-	1.6	10.5	11.4	400	2460	2900	11.3	10.8	10.4	
25 + 35 + 35 + 60		1.69	2.37	2.37	4.06	-	1.6	10.5	11.4	400	2460	2900	11.3	10.8	10.4	
25 + 35 + 50 + 50		1.64	2.30	3.28	3.28	-	1.6	10.5	11.4	400	2460	2900	11.3	10.8	10.4	
35 + 35 + 35 + 35		2.63	2.63	2.63	2.63	-	1.6	10.5	11.4	400	2460	2900	11.3	10.8	10.4	
35 + 35 + 35 + 50		2.37	2.37	2.37	3.39	-	1.6	10.5	11.4	400	2460	2900	11.3	10.8	10.4	
5 room		20 + 20 + 20 + 20 + 20	2.10	2.10	2.10	2.10	1.8	10.5	11.5	370	2380	2900	10.9	10.5	10.0	
		20 + 20 + 20 + 20 + 25	2.00	2.00	2.00	2.50	1.8	10.5	11.5	370	2380	2900	10.9	10.5	10.0	
		20 + 20 + 20 + 20 + 35	1.83	1.83	1.83	3.20	1.8	10.5	11.5	370	2380	2900	10.9	10.5	10.0	
		20 + 20 + 20 + 20 + 50	1.62	1.62	1.62	4.04	1.8	10.5	11.5	370	2380	2900	10.9	10.5	10.0	
		20 + 20 + 20 + 20 + 60	1.50	1.50	1.50	4.50	1.8	10.5	11.5	370	2380	2900	10.9	10.5	10.0	
		20 + 20 + 20 + 25 + 25	1.91	1.91	1.91	2.39	1.8	10.5	11.5	370	2380	2900	10.9	10.5	10.0	
20 + 20 + 20 + 25 + 35		1.75	1.75	1.75	2.19	1.8	10.5	11.5	370	2380	2900	10.9	10.5	10.0		



MULTI-SPLIT SYSTEM

Indoor unit combination		Heating capacity (kW)						Power consumption(W)			Standard current(A)					
		Room heating capacity				Total capacity		Min.	Standard	Max.	220V	230V	240V			
		A	B	C	D	E	Min.							Standard	Max.	
Heating operation	5 room	20 + 20 + 20 + 25 + 50	1.56	1.56	1.56	1.94	3.89	1.8	10.5	11.5	370	2380	2900	10.9	10.5	10.0
		20 + 20 + 20 + 25 + 60	1.45	1.45	1.45	1.81	4.34	1.8	10.5	11.5	370	2380	2900	10.9	10.5	10.0
		20 + 20 + 20 + 35 + 35	1.62	1.62	1.62	2.83	2.83	1.8	10.5	11.5	370	2380	2900	10.9	10.5	10.0
		20 + 20 + 20 + 35 + 50	1.45	1.45	1.45	2.53	3.62	1.8	10.5	11.5	370	2380	2900	10.9	10.5	10.0
		20 + 20 + 20 + 35 + 60	1.35	1.35	1.35	2.37	4.06	1.8	10.5	11.5	370	2380	2900	10.9	10.5	10.0
		20 + 20 + 25 + 25 + 25	1.83	1.83	2.28	2.28	2.28	1.8	10.5	11.5	370	2380	2900	10.9	10.5	10.0
		20 + 20 + 25 + 25 + 35	1.68	1.68	2.10	2.10	2.94	1.8	10.5	11.5	370	2380	2900	10.9	10.5	10.0
		20 + 20 + 25 + 25 + 50	1.50	1.50	1.88	1.88	3.75	1.8	10.5	11.5	370	2380	2900	10.9	10.5	10.0
		20 + 20 + 25 + 25 + 60	1.40	1.40	1.75	1.75	4.20	1.8	10.5	11.5	370	2380	2900	10.9	10.5	10.0
		20 + 20 + 25 + 35 + 35	1.56	1.56	1.94	2.72	2.72	1.8	10.5	11.5	370	2380	2900	10.9	10.5	10.0
		20 + 20 + 25 + 35 + 50	1.40	1.40	1.75	2.45	3.50	1.8	10.5	11.5	370	2380	2900	10.9	10.5	10.0
		20 + 20 + 25 + 35 + 60	1.31	1.31	1.64	2.30	3.94	1.8	10.5	11.5	370	2380	2900	10.9	10.5	10.0
		20 + 20 + 35 + 35 + 35	1.45	1.45	2.53	2.53	2.53	1.8	10.5	11.5	370	2380	2900	10.9	10.5	10.0
		20 + 20 + 35 + 35 + 50	1.31	1.31	2.30	2.30	3.28	1.8	10.5	11.5	370	2380	2900	10.9	10.5	10.0
		20 + 25 + 25 + 25 + 25	1.75	2.19	2.19	2.19	2.19	1.8	10.5	11.5	370	2380	2900	10.9	10.5	10.0
		20 + 25 + 25 + 25 + 35	1.62	2.02	2.02	2.02	2.83	1.8	10.5	11.5	370	2380	2900	10.9	10.5	10.0
		20 + 25 + 25 + 25 + 50	1.45	1.81	1.81	1.81	3.62	1.8	10.5	11.5	370	2380	2900	10.9	10.5	10.0
		20 + 25 + 25 + 25 + 60	1.35	1.69	1.69	1.69	4.06	1.8	10.5	11.5	370	2380	2900	10.9	10.5	10.0
		20 + 25 + 25 + 35 + 35	1.50	1.88	1.88	2.63	2.63	1.8	10.5	11.5	370	2380	2900	10.9	10.5	10.0
		20 + 25 + 25 + 35 + 50	1.35	1.69	1.69	2.37	3.39	1.8	10.5	11.5	370	2380	2900	10.9	10.5	10.0
		20 + 25 + 25 + 35 + 60	1.40	1.75	2.45	2.45	2.45	1.8	10.5	11.5	370	2380	2900	10.9	10.5	10.0
		20 + 35 + 35 + 35 + 35	1.31	2.30	2.30	2.30	2.30	1.8	10.5	11.5	370	2380	2900	10.9	10.5	10.0
		25 + 25 + 25 + 25 + 25	2.10	2.10	2.10	2.10	2.10	1.8	10.5	11.5	370	2380	2900	10.9	10.5	10.0
		25 + 25 + 25 + 25 + 35	1.94	1.94	1.94	1.94	2.72	1.8	10.5	11.5	370	2380	2900	10.9	10.5	10.0
		25 + 25 + 25 + 25 + 50	1.75	1.75	1.75	1.75	3.50	1.8	10.5	11.5	370	2380	2900	10.9	10.5	10.0
		25 + 25 + 25 + 25 + 60	1.64	1.64	1.64	1.64	3.94	1.8	10.5	11.5	370	2380	2900	10.9	10.5	10.0
		25 + 25 + 25 + 35 + 35	1.81	1.81	1.81	2.53	2.53	1.8	10.5	11.5	370	2380	2900	10.9	10.5	10.0
25 + 25 + 25 + 35 + 50	1.64	1.64	1.64	2.30	3.28	1.8	10.5	11.5	370	2380	2900	10.9	10.5	10.0		
25 + 25 + 35 + 35 + 35	1.69	1.69	2.37	2.37	2.37	1.8	10.5	11.5	370	2380	2900	10.9	10.5	10.0		

Indoor unit combination		Cooling capacity (kW)						Power consumption(W)			Standard current(A)				
		Room cooling capacity				Total capacity		Min.	Standard	Max.	220V	230V	240V		
		A	B	C	D	E	Min.							Standard	Max.
1 room	20	2.00	-	-	-	-	1.7	2.0	2.7	500	530	950	2.5	2.4	2.3
	25	2.50	-	-	-	-	1.7	2.5	3.2	500	690	1008	3.3	3.1	3.0
	35	3.50	-	-	-	-	1.7	3.5	3.7	500	1010	1340	4.8	4.6	4.4
	50	5.00	-	-	-	-	1.7	5.0	5.8	500	1490	1730	6.9	6.6	6.3
	60	6.00	-	-	-	-	1.7	6.0	6.7	500	1810	1990	8.3	8.0	7.6
	71	7.10	-	-	-	-	1.7	7.10	7.2	500	2170	2270	10.1	9.6	9.2
	80	8.00	-	-	-	-	1.7	8.00	8.1	500	2450	2500	11.4	10.9	10.4
	20 + 20	2.00	2.00	-	-	-	1.9	4.0	5.8	495	850	1430	4.0	3.8	3.7
20 + 25	2.00	2.50	-	-	-	1.9	4.5	6.1	495	1010	1540	4.7	4.5	4.3	
20 + 35	2.00	3.50	-	-	-	1.9	5.5	6.6	495	1330	1720	6.2	5.9	5.7	
20 + 50	2.00	5.00	-	-	-	1.9	7.0	7.7	495	1880	2170	8.6	8.2	7.9	
20 + 60	2.00	6.00	-	-	-	1.9	8.0	8.8	495	2300	2690	10.7	10.2	9.8	
20 + 71	2.00	7.10	-	-	-	1.9	9.1	10.0	495	2850	3420	13.2	12.6	12.1	
20 + 80	2.00	8.00	-	-	-	1.9	10.0	10.3	495	3450	3650	16.0	15.3	14.7	
25 + 25	2.50	2.50	-	-	-	1.9	5.0	6.5	495	1170	1690	5.4	5.2	5.0	
25 + 35	2.50	3.50	-	-	-	1.9	6.0	6.8	495	1600	1800	7.4	7.1	6.8	
25 + 50	2.50	5.00	-	-	-	1.9	7.5	8.4	495	2080	2490	9.6	9.2	8.8	
25 + 60	2.50	6.00	-	-	-	1.9	8.5	9.4	495	2630	3020	12.2	11.7	11.2	
25 + 71	2.50	7.10	-	-	-	1.9	9.6	10.2	495	3140	3570	14.6	13.9	13.4	
25 + 80	2.38	7.62	-	-	-	1.9	10.0	10.3	495	3450	3650	16.0	15.3	14.7	
35 + 35	3.50	3.50	-	-	-	1.9	7.0	7.7	495	1880	2170	8.6	8.2	7.9	
35 + 50	3.50	5.00	-	-	-	1.9	8.5	9.4	495	2630	3020	12.2	11.7	11.2	
35 + 60	3.50	6.00	-	-	-	1.9	9.5	10.2	495	3080	3570	14.3	13.7	13.1	
35 + 71	3.30	6.70	-	-	-	1.9	10.0	10.3	495	3450	3650	16.0	15.3	14.7	
35 + 80	3.04	6.96	-	-	-	1.9	10.0	10.3	495	3450	3650	16.0	15.3	14.7	
50 + 50	5.00	5.00	-	-	-	1.9	10.0	10.3	495	3450	3650	16.0	15.3	14.7	
50 + 60	4.55	5.45	-	-	-	1.9	10.0	10.3	495	3450	3650	16.0	15.3	14.7	
50 + 71	4.13	5.87	-	-	-	1.9	10.0	10.3	495	3450	3650	16.0	15.3	14.7	
50 + 80	3.85	6.15	-	-	-	1.9	10.0	10.3	495	3450	3650	16.0	15.3	14.7	
60 + 60	5.00	5.00	-	-	-	1.9	10.0	10.3	495	3450	3650	16.0	15.3	14.7	
60 + 71	4.58	5.42	-	-	-	1.9	10.0	10.3	495	3450	3650	16.0	15.3	14.7	
60 + 80	4.29	5.71	-	-	-	1.9	10.0	10.3	495	3450	3650	16.0	15.3	14.7	
71 + 71	5.00	5.00	-	-	-	1.9	10.0	10.3	495	3450	3650	16.0	15.3	14.7	
71 + 80	4.70	5.30	-	-	-	1.9	10.0	10.3	495	3450	3650	16.0	15.3	14.7	
80 + 80	5.00	5.00	-	-	-	1.9	10.0	10.3	495	3450	3650	16.0	15.3	14.7	
20 + 20 + 20	2.00	2.00	2.00	-	-	2.1	6.0	7.4	490	1430	1930	6.6	6.3	6.1	
20 + 20 + 25	2.00	2.00	2.50	-	-	2.1	6.5	7.7	490	1600	2050	7.4	7.1	6.8	
20 + 20 + 35	2.00	2.00	3.50	-	-	2.1	7.5	8.6	490	1970	2430	9.1	8.7	8.4	
20 + 20 + 50	2.00	2.00	5.00	-	-	2.1	9.0	9.6	490	2610	2920	12.1	11.6	11.1	
20 + 20 + 60	2.00	2.00	6.00	-	-	2.1	10.0	10.7	490	3230	3650	15.0	14.3	13.7	
20 + 20 + 71	1.80	1.80	6.40	-	-	2.1	10.0	10.7	490	3230	3650	15.0	14.3	13.7	
20 + 20 + 80	1.67	1.67	6.67	-	-	2.1	10.0	10.7	490	3230	3650	15.0	14.3	13.7	
20 + 25 + 25	2.00	2.50	2.50	-	-	2.1	7.0	8.0	490	1780	2170	8.2	7.8	7.5	
20 + 25 + 35	2.00	2.50	3.50	-	-	2.1	8.0	9.0	490	2170	2160	10.1	9.6	9.2	
20 + 25 + 50	2.00	2.50	5.00	-	-	2.1	9.5	10.3	490	2870	3340	13.3	12.7	12.2	
20 + 25 + 60	1.90	2.38	5.71	-	-	2.1	10.0	10.7	490	3230	3650	15.0	14.3	13.7	
20 + 35 + 35	2.00	3.50	3.50	-	-	2.1	9.0	9.6	490	2610	2920	12.1	11.6	11.1	

COMBINATIONS

Indoor unit combination		Cooling capacity (kW)									Power consumption(W)			Standard current(A)		
		Room cooling capacity					Total capacity				Min.	Standard	Max.	220V	230V	240V
		A	B	C	D	E	Min.	Standard	Max.							
Cooling operation	3 room	20 + 35 + 50	1.90	3.33	4.76	-	-	2.1	10.0	10.7	490	3230	3650	15.0	14.3	13.7
		20 + 35 + 60	1.74	3.04	5.22	-	-	2.1	10.0	10.7	490	3230	3650	15.0	14.3	13.7
		20 + 35 + 71	1.59	2.78	5.63	-	-	2.1	10.0	10.7	490	3230	3650	15.0	14.3	13.7
		20 + 35 + 80	1.48	2.59	5.93	-	-	2.1	10.0	10.7	490	3230	3650	15.0	14.3	13.7
		20 + 50 + 50	1.67	4.17	4.17	-	-	2.1	10.0	10.7	490	3230	3650	15.0	14.3	13.7
		20 + 50 + 60	1.54	3.85	4.62	-	-	2.1	10.0	10.7	490	3230	3650	15.0	14.3	13.7
		20 + 50 + 71	1.42	3.55	5.04	-	-	2.1	10.0	10.7	490	3230	3650	15.0	14.3	13.7
		20 + 50 + 80	1.33	3.33	5.33	-	-	2.1	10.0	10.7	490	3230	3650	15.0	14.3	13.7
		20 + 60 + 60	1.43	4.29	4.29	-	-	2.1	10.0	10.7	490	3230	3650	15.0	14.3	13.7
		20 + 60 + 71	1.32	3.97	4.70	-	-	2.1	10.0	10.7	490	3230	3650	15.0	14.3	13.7
		20 + 60 + 80	1.25	3.75	5.00	-	-	2.1	10.0	10.7	490	3230	3650	15.0	14.3	13.7
		25 + 25 + 25	2.50	2.50	2.50	-	-	2.1	7.5	8.6	490	1970	2430	9.1	8.7	8.4
		25 + 25 + 35	2.50	2.50	3.50	-	-	2.1	8.5	9.2	490	2380	2710	11.0	10.6	10.1
		25 + 25 + 50	2.50	2.50	5.00	-	-	2.1	10.0	10.7	490	3230	3650	15.0	14.3	13.7
		25 + 25 + 60	2.27	2.27	5.45	-	-	2.1	10.0	10.7	490	3230	3650	15.0	14.3	13.7
		25 + 25 + 71	2.07	2.07	5.87	-	-	2.1	10.0	10.7	490	3230	3650	15.0	14.3	13.7
		25 + 25 + 80	1.92	1.92	6.15	-	-	2.1	10.0	10.7	490	3230	3650	15.0	14.3	13.7
		25 + 35 + 35	2.50	3.50	3.50	-	-	2.1	9.5	10.3	490	2870	3340	13.3	12.7	12.2
		25 + 35 + 50	2.27	3.18	4.55	-	-	2.1	10.0	10.7	490	3230	3650	15.0	14.3	13.7
		25 + 35 + 60	2.08	2.92	5.00	-	-	2.1	10.0	10.7	490	3230	3650	15.0	14.3	13.7
		25 + 35 + 71	1.91	2.67	5.42	-	-	2.1	10.0	10.7	490	3230	3650	15.0	14.3	13.7
		25 + 35 + 80	1.79	2.50	5.71	-	-	2.1	10.0	10.7	490	3230	3650	15.0	14.3	13.7
		25 + 50 + 50	2.00	4.00	4.00	-	-	2.1	10.0	10.7	490	3230	3650	15.0	14.3	13.7
		25 + 50 + 60	1.85	3.70	4.44	-	-	2.1	10.0	10.7	490	3230	3650	15.0	14.3	13.7
		25 + 50 + 71	1.71	3.42	4.86	-	-	2.1	10.0	10.7	490	3230	3650	15.0	14.3	13.7
		25 + 50 + 80	1.61	3.23	5.16	-	-	2.1	10.0	10.7	490	3230	3650	15.0	14.3	13.7
		25 + 60 + 60	1.72	4.14	4.14	-	-	2.1	10.0	10.7	490	3230	3650	15.0	14.3	13.7
		25 + 60 + 71	1.60	3.85	4.55	-	-	2.1	10.0	10.7	490	3230	3650	15.0	14.3	13.7
		35 + 35 + 35	3.33	3.33	3.33	-	-	2.1	10.0	10.7	490	3230	3650	15.0	14.3	13.7
		35 + 35 + 50	2.92	2.92	4.17	-	-	2.1	10.0	10.7	490	3230	3650	15.0	14.3	13.7
35 + 35 + 60	2.69	2.69	4.62	-	-	2.1	10.0	10.7	490	3230	3650	15.0	14.3	13.7		
35 + 35 + 71	2.48	2.48	5.04	-	-	2.1	10.0	10.7	490	3230	3650	15.0	14.3	13.7		
35 + 35 + 80	2.33	2.33	5.33	-	-	2.1	10.0	10.7	490	3230	3650	15.0	14.3	13.7		
35 + 50 + 50	2.59	3.70	3.70	-	-	2.1	10.0	10.7	490	3230	3650	15.0	14.3	13.7		
35 + 50 + 60	2.41	3.45	4.14	-	-	2.1	10.0	10.7	490	3230	3650	15.0	14.3	13.7		
35 + 50 + 71	2.24	3.21	4.55	-	-	2.1	10.0	10.7	490	3230	3650	15.0	14.3	13.7		
35 + 60 + 60	2.26	3.87	3.87	-	-	2.1	10.0	10.7	490	3230	3650	15.0	14.3	13.7		
50 + 50 + 50	3.33	3.33	3.33	-	-	2.1	10.0	10.7	490	3230	3650	15.0	14.3	13.7		
50 + 50 + 60	3.13	3.13	3.75	-	-	2.1	10.0	10.7	490	3230	3650	15.0	14.3	13.7		
Cooling operation	4 room	20 + 20 + 20 + 20	2.00	2.00	2.00	2.00	-	2.3	8.0	8.8	485	2020	2330	9.4	9.0	8.6
		20 + 20 + 20 + 25	2.00	2.00	2.00	2.50	-	2.3	8.5	9.4	485	2210	2590	10.3	9.8	9.4
		20 + 20 + 20 + 35	2.00	2.00	2.00	3.50	-	2.3	9.5	10.5	485	2640	3150	12.2	11.7	11.2
		20 + 20 + 20 + 50	1.82	1.82	1.82	4.55	-	2.3	10.0	11.3	485	2950	3650	13.7	13.1	12.5
		20 + 20 + 20 + 60	1.67	1.67	1.67	5.00	-	2.3	10.0	11.3	485	2950	3650	13.7	13.1	12.5
		20 + 20 + 20 + 71	1.53	1.53	1.53	5.42	-	2.3	10.0	11.3	485	2950	3650	13.7	13.1	12.5
		20 + 20 + 20 + 80	1.43	1.43	1.43	5.71	-	2.3	10.0	11.3	485	2950	3650	13.7	13.1	12.5
		20 + 20 + 25 + 25	2.00	2.00	2.50	2.50	-	2.3	9.0	9.9	485	2420	2830	11.2	10.7	10.3
		20 + 20 + 25 + 35	2.00	2.00	2.50	3.50	-	2.3	10.0	11.3	485	2950	3650	13.7	13.1	12.5
		20 + 20 + 25 + 50	1.74	1.74	2.17	4.35	-	2.3	10.0	11.3	485	2950	3650	13.7	13.1	12.5
		20 + 20 + 25 + 60	1.60	1.60	2.00	4.80	-	2.3	10.0	11.3	485	2950	3650	13.7	13.1	12.5
		20 + 20 + 25 + 71	1.47	1.47	1.84	5.22	-	2.3	10.0	11.3	485	2950	3650	13.7	13.1	12.5
		20 + 20 + 25 + 80	1.38	1.38	1.72	5.52	-	2.3	10.0	11.3	485	2950	3650	13.7	13.1	12.5
		20 + 20 + 35 + 35	1.82	1.82	3.18	3.18	-	2.3	10.0	11.3	485	2950	3650	13.7	13.1	12.5
		20 + 20 + 35 + 50	1.60	1.60	2.80	4.00	-	2.3	10.0	11.3	485	2950	3650	13.7	13.1	12.5
		20 + 20 + 35 + 60	1.48	1.48	2.59	4.44	-	2.3	10.0	11.3	485	2950	3650	13.7	13.1	12.5
		20 + 20 + 35 + 71	1.37	1.37	2.40	4.86	-	2.3	10.0	11.3	485	2950	3650	13.7	13.1	12.5
		20 + 20 + 35 + 80	1.29	1.29	2.26	5.16	-	2.3	10.0	11.3	485	2950	3650	13.7	13.1	12.5
		20 + 20 + 50 + 50	1.43	1.43	3.57	3.57	-	2.3	10.0	11.3	485	2950	3650	13.7	13.1	12.5
		20 + 20 + 50 + 60	1.33	1.33	3.33	4.00	-	2.3	10.0	11.3	485	2950	3650	13.7	13.1	12.5
		20 + 20 + 60 + 60	1.25	1.25	3.75	3.75	-	2.3	10.0	11.3	485	2950	3650	13.7	13.1	12.5
		20 + 25 + 25 + 25	2.00	2.50	2.50	2.50	-	2.3	9.5	10.5	485	2640	3150	12.2	11.7	11.2
		20 + 25 + 25 + 35	1.90	2.38	2.38	3.33	-	2.3	10.0	11.1	485	2950	3650	13.7	13.1	12.5
		20 + 25 + 25 + 50	1.67	2.08	2.08	4.17	-	2.3	10.0	11.1	485	2950	3650	13.7	13.1	12.5
		20 + 25 + 25 + 60	1.54	1.92	1.92	4.62	-	2.3	10.0	11.1	485	2950	3650	13.7	13.1	12.5
		20 + 25 + 25 + 71	1.42	1.77	1.77	5.04	-	2.3	10.0	11.1	485	2950	3650	13.7	13.1	12.5
		20 + 25 + 25 + 80	1.33	1.67	1.67	5.33	-	2.3	10.0	11.1	485	2950	3650	13.7	13.1	12.5
		20 + 25 + 35 + 35	1.74	2.17	3.04	3.04	-	2.3	10.0	11.1	485	2950	3650	13.7	13.1	12.5
		20 + 25 + 35 + 50	1.54	1.92	2.69	3.85	-	2.3	10.0	11.1	485	2950	3650	13.7	13.1	12.5
		20 + 25 + 35 + 60	1.43	1.79	2.50	4.29	-	2.3	10.0	11.1	485	2950	3650	13.7	13.1	12.5
20 + 25 + 35 + 71	1.32	1.66	2.32	4.70	-	2.3	10.0	11.1	485	2950	3650	13.7	13.1	12.5		
20 + 25 + 35 + 80	1.25	1.56	2.19	5.00	-	2.3	10.0	11.1	485	2950	3650	13.7	13.1	12.5		
20 + 25 + 50 + 50	1.38	1.72	3.45	3.45	-	2.3	10.0	11.1	485	2950	3650	13.7	13.1	12.5		
20 + 25 + 50 + 60	1.29	1.61	3.23	3.87	-	2.3	10.0	11.1	485	2950	3650	13.7	13.1	12.5		
20 + 35 + 35 + 35	1.60	2.80	2.80	2.80	-	2.3	10.0	11.1	485	2950	3650	13.7	13.1	12.5		
20 + 35 + 35 + 50	1.43	2.50	2.50	3.57	-	2.3	10.0	11.1	485	2950	3650	13.7	13.1	12.5		
20 + 35 + 35 + 60	1.33	2.33	2.33	4.00	-	2.3	10.0	11.1	485	2950	3650	13.7	13.1	12.5		
20 + 35 + 50 + 50	1.29	2.26	3.23	3.23	-	2.3	10.0	11.1	485	2950	3650	13.7	13.1	12.5		
25 + 25 + 25 + 25	2.50	2.50	2.50	2.50	-	2.3	10.0	11.1	485	2950	3650	13.7	13.1	12.5		
25 + 25 + 25 + 35	2.27	2.27	2.27	3.18	-	2.3	10.0	11.1	485	2950	3650	13.7	13.1	12.5		
25 + 25 + 25 + 50	2.00	2.00	2.00	4.00	-	2.3	10.0	11.1	485	2950	3650	13.7	13.1	12.5		



MULTI-SPLIT SYSTEM

Indoor unit combination		Cooling capacity (kW)							Power consumption(W)			Standard current(A)			
		Room cooling capacity					Total capacity			Min.	Standard	Max.	220V	230V	240V
		A	B	C	D	E	Min.	Standard	Max.						
4 room	25 + 25 + 25 + 60	1.85	1.85	1.85	4.44	-	2.3	10.0	11.1	485	2950	3650	13.7	13.1	12.5
	25 + 25 + 25 + 71	1.71	1.71	1.71	4.86	-	2.3	10.0	11.1	485	2950	3650	13.7	13.1	12.5
	25 + 25 + 25 + 80	1.61	1.61	1.61	5.16	-	2.3	10.0	11.1	485	2950	3650	13.7	13.1	12.5
	25 + 25 + 35 + 35	2.08	2.08	2.92	2.92	-	2.3	10.0	11.1	485	2950	3650	13.7	13.1	12.5
	25 + 25 + 35 + 50	1.85	1.85	2.59	3.70	-	2.3	10.0	11.1	485	2950	3650	13.7	13.1	12.5
	25 + 25 + 35 + 60	1.72	1.72	2.41	4.14	-	2.3	10.0	11.1	485	2950	3650	13.7	13.1	12.5
	25 + 25 + 35 + 71	1.60	1.60	2.24	4.55	-	2.3	10.0	11.1	485	2950	3650	13.7	13.1	12.5
	25 + 25 + 50 + 50	1.67	1.67	3.33	3.33	-	2.3	10.0	11.1	485	2950	3650	13.7	13.1	12.5
	25 + 25 + 50 + 60	1.56	1.56	3.13	3.75	-	2.3	10.0	11.1	485	2950	3650	13.7	13.1	12.5
	25 + 35 + 35 + 35	1.92	2.69	2.69	2.69	-	2.3	10.0	11.1	485	2950	3650	13.7	13.1	12.5
	25 + 35 + 35 + 50	1.72	2.41	2.41	3.45	-	2.3	10.0	11.1	485	2950	3650	13.7	13.1	12.5
	25 + 35 + 35 + 60	1.61	2.26	2.26	3.87	-	2.3	10.0	11.1	485	2950	3650	13.7	13.1	12.5
	25 + 35 + 50 + 50	1.56	2.19	3.13	3.13	-	2.3	10.0	11.1	485	2950	3650	13.7	13.1	12.5
	35 + 35 + 35 + 35	2.50	2.50	2.50	2.50	-	2.3	10.0	11.1	485	2950	3650	13.7	13.1	12.5
35 + 35 + 35 + 50	2.26	2.26	2.26	3.23	-	2.3	10.0	11.1	485	2950	3650	13.7	13.1	12.5	
Cooling operation 5 room	20 + 20 + 20 + 20 + 20	2.00	2.00	2.00	2.00	2.00	2.5	10.0	11.5	480	2700	3650	12.4	11.9	11.4
	20 + 20 + 20 + 20 + 25	1.90	1.90	1.90	1.90	2.38	2.5	10.0	11.5	480	2700	3650	12.4	11.9	11.4
	20 + 20 + 20 + 20 + 35	1.74	1.74	1.74	1.74	3.04	2.5	10.0	11.5	480	2700	3650	12.4	11.9	11.4
	20 + 20 + 20 + 20 + 50	1.54	1.54	1.54	1.54	3.85	2.5	10.0	11.5	480	2700	3650	12.4	11.9	11.4
	20 + 20 + 20 + 20 + 60	1.43	1.43	1.43	1.43	4.29	2.5	10.0	11.5	480	2700	3650	12.4	11.9	11.4
	20 + 20 + 20 + 25 + 25	1.82	1.82	1.82	2.27	2.27	2.5	10.0	11.5	480	2700	3650	12.4	11.9	11.4
	20 + 20 + 20 + 25 + 35	1.67	1.67	1.67	2.08	2.92	2.5	10.0	11.5	480	2700	3650	12.4	11.9	11.4
	20 + 20 + 20 + 25 + 50	1.48	1.48	1.48	1.85	3.70	2.5	10.0	11.5	480	2700	3650	12.4	11.9	11.4
	20 + 20 + 20 + 25 + 60	1.38	1.38	1.38	1.72	4.14	2.5	10.0	11.5	480	2700	3650	12.4	11.9	11.4
	20 + 20 + 20 + 35 + 35	1.54	1.54	1.54	2.69	2.69	2.5	10.0	11.5	480	2700	3650	12.4	11.9	11.4
	20 + 20 + 20 + 35 + 50	1.38	1.38	1.38	2.41	3.45	2.5	10.0	11.5	480	2700	3650	12.4	11.9	11.4
	20 + 20 + 20 + 35 + 60	1.29	1.29	1.29	2.26	3.87	2.5	10.0	11.5	480	2700	3650	12.4	11.9	11.4
	20 + 20 + 25 + 25 + 25	1.74	1.74	2.17	2.17	2.17	2.5	10.0	11.5	480	2700	3650	12.4	11.9	11.4
	20 + 20 + 25 + 25 + 35	1.60	1.60	2.00	2.00	2.80	2.5	10.0	11.5	480	2700	3650	12.4	11.9	11.4
	20 + 20 + 25 + 25 + 50	1.43	1.43	1.79	1.79	3.57	2.5	10.0	11.5	480	2700	3650	12.4	11.9	11.4
	20 + 20 + 25 + 25 + 60	1.33	1.33	1.67	1.67	4.00	2.5	10.0	11.5	480	2700	3650	12.4	11.9	11.4
	20 + 20 + 25 + 35 + 35	1.48	1.48	1.85	2.59	2.59	2.5	10.0	11.5	480	2700	3650	12.4	11.9	11.4
	20 + 20 + 25 + 35 + 50	1.33	1.33	1.67	2.33	3.33	2.5	10.0	11.5	480	2700	3650	12.4	11.9	11.4
	20 + 20 + 25 + 35 + 60	1.25	1.25	1.56	2.19	3.75	2.5	10.0	11.5	480	2700	3650	12.4	11.9	11.4
	20 + 20 + 35 + 35 + 35	1.38	1.38	2.41	2.41	2.41	2.5	10.0	11.5	480	2700	3650	12.4	11.9	11.4
	20 + 20 + 35 + 35 + 50	1.25	1.25	2.19	2.19	3.13	2.5	10.0	11.5	480	2700	3650	12.4	11.9	11.4
	20 + 25 + 25 + 25 + 25	1.67	2.08	2.08	2.08	2.08	2.5	10.0	11.5	480	2700	3650	12.4	11.9	11.4
	20 + 25 + 25 + 25 + 35	1.54	1.92	1.92	1.92	2.69	2.5	10.0	11.5	480	2700	3650	12.4	11.9	11.4
	20 + 25 + 25 + 25 + 50	1.38	1.72	1.72	1.72	3.45	2.5	10.0	11.5	480	2700	3650	12.4	11.9	11.4
	20 + 25 + 25 + 25 + 60	1.29	1.61	1.61	1.61	3.87	2.5	10.0	11.5	480	2700	3650	12.4	11.9	11.4
	20 + 25 + 25 + 35 + 35	1.43	1.79	1.79	2.50	2.50	2.5	10.0	11.5	480	2700	3650	12.4	11.9	11.4
	20 + 25 + 25 + 35 + 50	1.29	1.61	1.61	2.26	3.23	2.5	10.0	11.5	480	2700	3650	12.4	11.9	11.4
	20 + 25 + 35 + 35 + 35	1.33	1.67	2.33	2.33	2.33	2.5	10.0	11.5	480	2700	3650	12.4	11.9	11.4
	20 + 35 + 35 + 35 + 35	1.25	2.19	2.19	2.19	2.19	2.5	10.0	11.5	480	2700	3650	12.4	11.9	11.4
	25 + 25 + 25 + 25 + 25	2.00	2.00	2.00	2.00	2.00	2.5	10.0	11.5	480	2700	3650	12.4	11.9	11.4
	25 + 25 + 25 + 25 + 35	1.85	1.85	1.85	1.85	2.59	2.5	10.0	11.5	480	2700	3650	12.4	11.9	11.4
	25 + 25 + 25 + 25 + 50	1.67	1.67	1.67	1.67	3.33	2.5	10.0	11.5	480	2700	3650	12.4	11.9	11.4
	25 + 25 + 25 + 25 + 60	1.56	1.56	1.56	1.56	3.75	2.5	10.0	11.5	480	2700	3650	12.4	11.9	11.4
	25 + 25 + 25 + 35 + 35	1.72	1.72	1.72	2.41	2.41	2.5	10.0	11.5	480	2700	3650	12.4	11.9	11.4
25 + 25 + 25 + 35 + 50	1.56	1.56	1.56	2.19	3.13	2.5	10.0	11.5	480	2700	3650	12.4	11.9	11.4	
25 + 25 + 35 + 35 + 35	1.61	1.61	2.26	2.26	2.26	2.5	10.0	11.5	480	2700	3650	12.4	11.9	11.4	

SCM40ZS-S Table of Indoor unit combination only with SRK-ZSX type

Indoor unit combination		Heating capacity (kW)					Power consumption(W)			Standard current(A)			
		Room heating capacity		Total capacity			Min.	Standard	Max.	220V	230V	240V	
		A	B	Min.	Standard	Max.							
Heating operation	1* ¹ room	20	3.0	-	1.3	3.0	3.7	520	750	1070	3.7	3.5	3.4
		25	3.4	-	1.3	3.4	4.2	520	920	1210	4.5	4.3	4.1
		35	4.5	-	1.3	4.5	5.0	520	1210	1450	5.9	5.6	5.4
	2* ² room	20 + 20	2.25	2.25	2.0	4.5	6.3	550	900	1700	4.4	4.2	4.0
		20 + 25	2.36	2.94	2.0	5.3	6.3	550	1150	1700	5.4	5.2	5.0
		20 + 35	2.11	3.69	2.0	5.8	6.3	550	1290	1700	6.0	5.8	5.5
25 + 25		2.90	2.90	2.0	5.8	6.3	550	1290	1700	6.0	5.8	5.5	
	25 + 35	2.42	3.38	2.0	5.8	6.3	550	1290	1700	6.0	5.8	5.5	

The values are for 1 indoor unit (*1) and 2 indoor units (*2) operation.
The same hereinafter.

Indoor unit combination		Cooling capacity (kW)					Power consumption(W)			Standard current(A)				
		Room cooling capacity		Total capacity			Min.	Standard	Max.	220V	230V	240V		
		A	B	Min.	Standard	Max.								
Cooling operation	1 room	20	2.0	-	1.5	2.0	2.8	560	590	880	2.9	2.8	2.7	
		25	2.5	-	1.5	2.5	3.4	560	670	1040	3.3	3.2	3.1	
		35	3.5	-	1.5	3.5	3.9	560	970	1200	4.8	4.6	4.4	
	2 room	20 + 20	2.00	2.00	3.0	4.0	5.7	600	840	1750	4.2	4.0	3.8	
		20 + 25	2.00	2.50	3.0	4.5	5.9	600	1040	2030	5.0	4.8	4.6	
		20 + 35	1.89	3.31	3.0	5.2	5.9	600	1430	2030	6.7	6.4	6.2	
		25 + 25	2.50	2.50	3.0	5.0	5.9	600	1280	2030	6.1	5.8	5.6	
			25 + 35	2.17	3.03	3.0	5.2	5.9	600	1430	2030	6.7	6.4	6.2

SCM40ZS-S Table of Indoor unit combination only with SKM-ZSP type

Indoor unit combination		Heating capacity (kW)					Power consumption(W)			Standard current(A)			
		Room heating capacity		Total capacity			Min.	Standard	Max.	220V	230V	240V	
		A	B	Min.	Standard	Max.							
Heating operation	1 room	20	3.0	-	1.3	3.0	3.5	520	950	1070	4.6	4.4	4.2
		25	3.4	-	1.3	3.4	4.0	520	1020	1210	5.0	4.8	4.6
		35	4.5	-	1.3	4.5	4.8	520	1390	1450	6.8	6.5	6.2
	2 room	20 + 20	2.25	2.25	2.0	4.5	6.1	550	1020	1700	5.0	4.8	4.6
		20 + 25	2.36	2.94	2.0	5.3	6.1	550	1310	1700	6.2	5.9	5.7
		20 + 35	2.11	3.69	2.0	5.8	6.1	550	1400	1700	6.5	6.3	6.0
25 + 25		2.90	2.90	2.0	5.8	6.1	550	1400	1700	6.5	6.3	6.0	
	25 + 35	2.42	3.38	2.0	5.8	6.1	550	1400	1700	6.5	6.3	6.0	

Indoor unit combination		Cooling capacity (kW)					Power consumption(W)			Standard current(A)				
		Room cooling capacity		Total capacity			Min.	Standard	Max.	220V	230V	240V		
		A	B	Min.	Standard	Max.								
Cooling operation	1 room	20	2.0	-	1.5	2.0	2.7	560	650	880	3.2	3.1	3.0	
		25	2.5	-	1.5	2.5	3.2	560	830	1040	4.1	4.0	3.8	
		35	3.5	-	1.5	3.5	3.7	560	1100	1200	5.5	5.2	5.0	
	2 room	20 + 20	2.00	2.00	3.0	4.0	5.6	600	1050	1750	5.2	5.0	4.8	
		20 + 25	2.00	2.50	3.0	4.5	5.8	600	1300	2030	6.3	6.0	5.8	
		20 + 35	1.89	3.31	3.0	5.2	5.8	600	1600	2030	7.5	7.2	6.9	
		25 + 25	2.50	2.50	3.0	5.0	5.8	600	1420	2030	6.7	6.4	6.2	
			25 + 35	2.17	3.03	3.0	5.2	5.8	600	1600	2030	7.5	7.2	6.9

SCM40ZS-S Table of Indoor unit combination with other indoor unit

Indoor unit combination		Heating capacity (kW)					Power consumption(W)			Standard current(A)			
		Room heating capacity		Total capacity			Min.	Standard	Max.	220V	230V	240V	
		A	B	Min.	Standard	Max.							
Heating operation	1 room	20	3.0	-	1.3	3.0	3.5	520	900	1070	4.4	4.2	4.0
		25	3.4	-	1.3	3.4	4.0	520	1070	1210	5.2	5.0	4.8
		35	4.5	-	1.3	4.5	4.8	520	1340	1450	6.5	6.3	6.0
	2 room	20 + 20	2.25	2.25	2.0	4.5	6.1	550	930	1700	4.5	4.3	4.2
		20 + 25	2.36	2.94	2.0	5.3	6.1	550	1240	1700	5.9	5.6	5.4
		20 + 35	2.11	3.69	2.0	5.8	6.1	550	1330	1700	6.2	5.9	5.7
25 + 25		2.90	2.90	2.0	5.8	6.1	550	1330	1700	6.2	5.9	5.7	
	25 + 35	2.42	3.38	2.0	5.8	6.1	550	1330	1700	6.2	5.9	5.7	

Indoor unit combination		Cooling capacity (kW)					Power consumption(W)			Standard current(A)				
		Room cooling capacity		Total capacity			Min.	Standard	Max.	220V	230V	240V		
		A	B	Min.	Standard	Max.								
Cooling operation	1 room	20	2.0	-	1.5	2.0	2.7	560	620	880	3.1	3.0	2.8	
		25	2.5	-	1.5	2.5	3.2	560	710	1040	3.5	3.4	3.2	
		35	3.5	-	1.5	3.5	3.7	560	1030	1200	5.1	4.9	4.7	
	2 room	20 + 20	2.00	2.00	3.0	4.0	5.6	600	880	1750	4.4	4.2	4.0	
		20 + 25	2.00	2.50	3.0	4.5	5.8	600	1090	2030	5.3	5.0	4.8	
		20 + 35	1.89	3.31	3.0	5.2	5.8	600	1500	2030	7.0	6.7	6.5	
		25 + 25	2.50	2.50	3.0	5.0	5.8	600	1340	2030	6.4	6.1	5.8	
			25 + 35	2.17	3.03	3.0	5.2	5.8	600	1500	2030	7.0	6.7	6.5



MULTI-SPLIT SYSTEM

SCM45ZS-S Table of Indoor unit combination only with SRK-ZSX type

Indoor unit combination		Heating capacity (kW)					Power consumption(W)			Standard current(A)			
		Room heating capacity		Total capacity			Min.	Standard	Max.	220V	230V	240V	
		A	B	Min.	Standard	Max.							
Heating operation	1 room	20	3.0	-	1.3	3.0	3.7	520	750	1070	3.7	3.5	3.4
		25	3.4	-	1.3	3.4	4.2	520	920	1210	4.5	4.3	4.1
		35	4.5	-	1.3	4.5	5.0	520	1210	1450	5.9	5.6	5.4
2 room	20 + 20	2.25	2.25	2.0	4.5	6.5	550	900	1900	4.4	4.2	4.0	
	20 + 25	2.36	2.94	2.0	5.3	6.5	550	1150	1900	5.4	5.2	5.0	
	20 + 35	2.18	3.82	2.0	6.0	6.5	550	1500	1900	6.9	6.6	6.3	
	25 + 25	3.00	3.00	2.0	6.0	6.5	550	1500	1900	6.9	6.6	6.3	
	25 + 35	2.50	3.50	2.0	6.0	6.5	550	1500	1900	6.9	6.6	6.3	
	35 + 35	3.00	3.00	2.0	6.0	6.5	550	1500	1900	6.9	6.6	6.3	

Indoor unit combination		Cooling capacity (kW)					Power consumption(W)			Standard current(A)			
		Room cooling capacity		Total capacity			Min.	Standard	Max.	220V	230V	240V	
		A	B	Min.	Standard	Max.							
Cooling operation	1 room	20	2.0	-	1.5	2.0	2.8	560	590	880	2.9	2.8	2.7
		25	2.5	-	1.5	2.5	3.4	560	670	1040	3.3	3.2	3.1
		35	3.5	-	1.5	3.5	3.9	560	970	1200	4.8	4.6	4.4
2 room	20 + 20	2.00	2.00	3.0	4.0	5.7	600	840	1750	4.2	4.0	3.8	
	20 + 25	2.00	2.50	3.0	4.5	5.9	600	1040	2030	5.0	4.8	4.6	
	20 + 35	2.00	3.50	3.0	5.5	6.3	600	1490	2160	7.0	6.7	6.4	
	25 + 25	2.50	2.50	3.0	5.0	6.2	600	1280	2110	6.1	5.8	5.6	
	25 + 35	2.42	3.38	3.0	5.8	6.4	600	1740	2200	8.0	7.6	7.3	
	35 + 35	2.90	2.90	3.0	5.8	6.4	600	1740	2200	8.0	7.6	7.3	

SCM45ZS-S Table of Indoor unit combination only with SKM-ZSP type

Indoor unit combination		Heating capacity (kW)					Power consumption(W)			Standard current(A)			
		Room heating capacity		Total capacity			Min.	Standard	Max.	220V	230V	240V	
		A	B	Min.	Standard	Max.							
Heating operation	1 room	20	3.0	-	1.3	3.0	3.5	520	950	1070	4.6	4.4	4.2
		25	3.4	-	1.3	3.4	4.0	520	1020	1210	5.0	4.8	4.6
		35	4.5	-	1.3	4.5	4.8	520	1390	1450	6.8	6.5	6.2
2 room	20 + 20	2.25	2.25	2.0	4.5	6.3	550	1020	1900	5.0	4.8	4.6	
	20 + 25	2.36	2.94	2.0	5.3	6.3	550	1310	1900	6.4	6.1	5.9	
	20 + 35	2.18	3.82	2.0	6.0	6.3	550	1600	1900	7.3	7.0	6.7	
	25 + 25	3.00	3.00	2.0	6.0	6.3	550	1600	1900	7.3	7.0	6.7	
	25 + 35	2.50	3.50	2.0	6.0	6.3	550	1600	1900	7.3	7.0	6.7	
	35 + 35	3.00	3.00	2.0	6.0	6.3	550	1600	1900	7.3	7.0	6.7	

Indoor unit combination		Cooling capacity (kW)					Power consumption(W)			Standard current(A)			
		Room cooling capacity		Total capacity			Min.	Standard	Max.	220V	230V	240V	
		A	B	Min.	Standard	Max.							
Cooling operation	1 room	20	2.0	-	1.5	2.0	2.7	560	650	880	3.2	3.1	3.0
		25	2.5	-	1.5	2.5	3.2	560	830	1040	4.1	4.0	3.8
		35	3.5	-	1.5	3.5	3.7	560	1100	1200	5.5	5.2	5.0
2 room	20 + 20	2.00	2.00	3.0	4.0	5.6	600	1050	1750	5.2	5.0	4.8	
	20 + 25	2.00	2.50	3.0	4.5	5.8	600	1300	2030	6.3	6.0	5.8	
	20 + 35	2.00	3.50	3.0	5.5	6.2	600	1650	2160	7.7	7.4	7.1	
	25 + 25	2.50	2.50	3.0	5.0	6.1	600	1380	2110	6.5	6.3	6.0	
	25 + 35	2.42	3.38	3.0	5.8	6.3	600	1900	2200	8.7	8.3	8.0	
	35 + 35	2.90	2.90	3.0	5.8	6.3	600	1900	2200	8.7	8.3	8.0	

SCM45ZS-S Table of Indoor unit combination with other indoor unit

Indoor unit combination		Heating capacity (kW)					Power consumption(W)			Standard current(A)			
		Room heating capacity		Total capacity			Min.	Standard	Max.	220V	230V	240V	
		A	B	Min.	Standard	Max.							
Heating operation	1 room	20	3.0	-	1.3	3.0	3.5	520	900	1070	4.4	4.2	4.0
		25	3.4	-	1.3	3.4	4.0	520	1070	1210	5.2	5.0	4.8
		35	4.5	-	1.3	4.5	4.8	520	1340	1450	6.5	6.3	6.0
2 room	20 + 20	2.25	2.25	2.0	4.5	6.3	550	930	1900	4.5	4.3	4.2	
	20 + 25	2.36	2.94	2.0	5.3	6.3	550	1240	1900	6.0	5.8	5.5	
	20 + 35	2.18	3.82	2.0	6.0	6.3	550	1550	1900	7.1	6.8	6.5	
	25 + 25	3.00	3.00	2.0	6.0	6.3	550	1550	1900	7.1	6.8	6.5	
	25 + 35	2.50	3.50	2.0	6.0	6.3	550	1550	1900	7.1	6.8	6.5	
	35 + 35	3.00	3.00	2.0	6.0	6.3	550	1550	1900	7.1	6.8	6.5	

Indoor unit combination		Cooling capacity (kW)					Power consumption(W)			Standard current(A)			
		Room cooling capacity		Total capacity			Min.	Standard	Max.	220V	230V	240V	
		A	B	Min.	Standard	Max.							
Cooling operation	1 room	20	2.0	-	1.5	2.0	2.7	560	620	880	3.1	3.0	2.8
		25	2.5	-	1.5	2.5	3.2	560	710	1040	3.5	3.4	3.2
		35	3.5	-	1.5	3.5	3.7	560	1030	1200	5.1	4.9	4.7
2 room	20 + 20	2.00	2.00	3.0	4.0	5.6	600	880	1750	4.4	4.2	4.0	
	20 + 25	2.00	2.50	3.0	4.5	5.8	600	1090	2030	5.3	5.0	4.8	
	20 + 35	2.00	3.50	3.0	5.5	6.2	600	1560	2160	7.3	7.0	6.7	
	25 + 25	2.50	2.50	3.0	5.0	6.1	600	1340	2110	6.4	6.1	5.8	
	25 + 35	2.42	3.38	3.0	5.8	6.3	600	1820	2200	8.4	8.0	7.7	
	35 + 35	2.90	2.90	3.0	5.8	6.3	600	1820	2200	8.4	8.0	7.7	

COMBINATIONS

SCM50ZS-S1 Table of Indoor unit combination only with SRK-ZSX type

Indoor unit combination		Heating capacity (kW)						Power consumption(W)			Standard current(A)			
		Room heating capacity			Total capacity			Min.	Standard	Max.	220V	230V	240V	
		A	B	C	Min.	Standard	Max.							
Heating operation	1 room	20	3.0	-	-	1.4	3.0	3.7	480	820	1100	3.9	3.7	3.6
		25	3.4	-	-	1.4	3.4	4.2	480	980	1240	4.6	4.4	4.2
		35	4.5	-	-	1.4	4.5	5.0	480	1270	1490	6.0	5.7	5.5
		50	5.8	-	-	1.4	5.8	6.2	480	1710	2260	7.9	7.6	7.3
	2 room	20 + 20	2.95	2.95	-	2.0	5.9	7.3	540	1450	2580	6.7	6.4	6.2
		20 + 25	2.67	3.33	-	2.0	6.0	7.3	540	1500	2580	7.0	6.7	6.4
		20 + 35	2.29	4.01	-	2.0	6.3	7.3	540	1580	2580	7.3	7.0	6.7
		20 + 50	1.89	4.71	-	2.0	6.6	7.3	540	1670	2580	7.7	7.4	7.1
		25 + 25	3.05	3.05	-	2.0	6.1	7.3	540	1530	2580	7.1	6.8	6.5
		25 + 35	2.67	3.73	-	2.0	6.4	7.3	540	1610	2580	7.5	7.1	6.8
		25 + 50	2.20	4.40	-	2.0	6.6	7.3	540	1670	2580	7.7	7.4	7.1
		35 + 35	3.30	3.30	-	2.0	6.6	7.3	540	1670	2580	7.7	7.4	7.1
3 room	20 + 20 + 20	2.00	2.00	2.00	3.0	6.0	7.5	600	1210	2580	5.6	5.4	5.1	
	20 + 20 + 25	1.91	1.91	2.38	3.0	6.2	7.5	600	1370	2580	6.4	6.1	5.8	
	20 + 20 + 35	1.76	1.76	3.08	3.0	6.6	7.5	600	1520	2580	7.1	6.7	6.5	
	20 + 25 + 25	1.83	2.29	2.29	3.0	6.4	7.5	600	1430	2580	6.6	6.3	6.1	
	20 + 25 + 35	1.70	2.13	2.98	3.0	6.8	7.5	600	1580	2580	7.3	7.0	6.7	
	25 + 25 + 25	2.20	2.20	2.20	3.0	6.6	7.5	600	1520	2580	7.1	6.7	6.5	
	25 + 25 + 35	2.06	2.06	2.88	3.0	7.0	7.5	600	1640	2580	7.6	7.3	7.0	

Indoor unit combination		Cooling capacity (kW)						Power consumption(W)			Standard current(A)			
		Room cooling capacity			Total capacity			Min.	Standard	Max.	220V	230V	240V	
		A	B	C	Min.	Standard	Max.							
Cooling operation	1 room	20	2.0	-	-	1.8	2.0	2.8	500	550	900	2.6	2.5	2.4
		25	2.5	-	-	1.8	2.5	3.4	500	720	1070	3.4	3.2	3.1
		35	3.5	-	-	1.8	3.5	3.9	500	1080	1230	5.1	4.8	4.6
		50	5.0	-	-	1.8	5.0	5.5	500	1700	2000	7.9	7.5	7.2
	2 room	20 + 20	2.00	2.00	-	3.0	4.0	5.7	570	910	1800	4.2	4.1	3.9
		20 + 25	1.91	2.39	-	3.0	4.3	5.9	570	1070	1980	5.0	4.8	4.6
		20 + 35	1.82	3.18	-	3.0	5.0	6.2	570	1430	2070	6.6	6.3	6.1
		20 + 50	1.71	4.29	-	3.0	6.0	6.5	570	1960	2150	9.0	8.6	8.2
		25 + 25	2.35	2.35	-	3.0	4.7	6.2	570	1270	2070	5.9	5.6	5.4
		25 + 35	2.21	3.09	-	3.0	5.3	6.5	570	1600	2150	7.4	7.1	6.8
		25 + 50	2.00	4.00	-	3.0	6.0	6.5	570	1960	2150	9.0	8.6	8.2
		35 + 35	3.00	3.00	-	3.0	6.0	6.5	570	1960	2150	9.0	8.6	8.2
3 room	20 + 20 + 20	1.67	1.67	1.67	3.4	5.0	7.1	690	1050	2150	4.9	4.7	4.5	
	20 + 20 + 25	1.60	1.60	2.00	3.4	5.2	7.1	690	1160	2150	5.4	5.1	4.9	
	20 + 20 + 35	1.49	1.49	2.61	3.4	5.6	7.1	690	1330	2150	6.2	5.9	5.7	
	20 + 25 + 25	1.54	1.93	1.93	3.4	5.4	7.1	690	1260	2150	5.8	5.6	5.4	
	20 + 25 + 35	1.45	1.81	2.54	3.4	5.8	7.1	690	1430	2150	6.6	6.3	6.1	
	25 + 25 + 25	1.87	1.87	1.87	3.4	5.6	7.1	690	1330	2150	6.2	5.9	5.7	
	25 + 25 + 35	1.76	1.76	2.47	3.4	6.0	7.1	690	1490	2150	6.9	6.6	6.3	

SCM50ZS-S1 Table of Indoor unit combination only with SKM-ZSP type

Indoor unit combination		Heating capacity (kW)						Power consumption(W)			Standard current(A)			
		Room heating capacity			Total capacity			Min.	Standard	Max.	220V	230V	240V	
		A	B	C	Min.	Standard	Max.							
Heating operation	1 room	20	3.0	-	-	1.4	3.0	3.5	480	1040	1100	4.9	4.7	4.5
		25	3.4	-	-	1.4	3.4	4.0	480	1200	1240	5.7	5.4	5.2
		35	4.5	-	-	1.4	4.5	4.8	480	1490	1490	7.0	6.7	6.4
	2 room	20 + 20	2.95	2.95	-	2.0	5.9	7.0	540	1530	2580	7.1	6.8	6.5
		20 + 25	2.67	3.33	-	2.0	6.0	7.0	540	1580	2580	7.3	7.0	6.7
		20 + 35	2.29	4.01	-	2.0	6.3	7.0	540	1670	2580	7.7	7.4	7.1
		25 + 25	3.05	3.05	-	2.0	6.1	7.0	540	1610	2580	7.5	7.1	6.8
		25 + 35	2.67	3.73	-	2.0	6.4	7.0	540	1700	2580	7.9	7.5	7.2
		35 + 35	3.30	3.30	-	2.0	6.6	7.0	540	1760	2580	8.1	7.8	7.4
	3 room	20 + 20 + 20	2.00	2.00	2.00	3.0	6.0	7.3	600	1360	2580	6.3	6.0	5.8
		20 + 20 + 25	1.91	1.91	2.38	3.0	6.2	7.3	600	1450	2580	6.7	6.4	6.2
		20 + 20 + 35	1.76	1.76	3.08	3.0	6.6	7.3	600	1620	2580	7.5	7.2	6.9
20 + 25 + 25		1.83	2.29	2.29	3.0	6.4	7.3	600	1530	2580	7.1	6.8	6.5	
20 + 25 + 35		1.70	2.13	2.98	3.0	6.8	7.3	600	1680	2580	7.8	7.5	7.1	
25 + 25 + 25		2.20	2.20	2.20	3.0	6.6	7.3	600	1620	2580	7.5	7.2	6.9	
25 + 25 + 35		2.06	2.06	2.88	3.0	7.0	7.3	600	1750	2580	8.1	7.7	7.4	



MULTI-SPLIT SYSTEM

Indoor unit combination		Cooling capacity (kW)						Power consumption(W)			Standard current(A)			
		Room cooling capacity			Total capacity			Min.	Standard	Max.	220V	230V	240V	
		A	B	C	Min.	Standard	Max.							
Cooling operation	1 room	20	2.0	-	-	1.8	2.0	2.7	500	610	900	2.9	2.8	2.6
		25	2.5	-	-	1.8	2.5	3.2	500	800	1070	3.8	3.6	3.5
		35	3.5	-	-	1.8	3.5	3.7	500	1170	1230	5.5	5.2	5.0
	2 room	20 + 20	2.00	2.00	-	3.0	4.0	5.6	570	1000	1800	4.7	4.5	4.3
		20 + 25	1.91	2.39	-	3.0	4.3	5.8	570	1150	1980	5.4	5.1	4.9
		20 + 35	1.82	3.18	-	3.0	5.0	6.1	570	1530	2070	7.1	6.8	6.5
		25 + 25	2.35	2.35	-	3.0	4.7	6.1	570	1520	2070	7.1	6.8	6.5
		25 + 35	2.21	3.09	-	3.0	5.3	6.3	570	1720	2150	8.0	7.6	7.3
		35 + 35	3.00	3.00	-	3.0	6.0	6.3	570	2050	2150	9.4	9.0	8.6
	3 room	20 + 20 + 20	1.67	1.67	1.67	3.4	5.0	6.9	690	1160	2150	5.4	5.1	4.9
		20 + 20 + 25	1.60	1.60	2.00	3.4	5.2	6.9	690	1250	2150	5.8	5.5	5.3
		20 + 20 + 35	1.49	1.49	2.61	3.4	5.6	6.9	690	1400	2150	6.5	6.2	6.0
		20 + 25 + 25	1.54	1.93	1.93	3.4	5.4	6.9	690	1350	2150	6.3	6.0	5.7
		20 + 25 + 35	1.45	1.81	2.54	3.4	5.8	6.9	690	1500	2150	7.0	6.7	6.4
		25 + 25 + 25	1.87	1.87	1.87	3.4	5.6	6.9	690	1400	2150	6.5	6.2	6.0
25 + 25 + 35		1.76	1.76	2.47	3.4	6.0	6.9	690	1600	2150	7.4	7.1	6.8	

SCM50ZS-S1 Table of Indoor unit combination with other indoor unit

Indoor unit combination		Heating capacity (kW)						Power consumption(W)			Standard current(A)			
		Room heating capacity			Total capacity			Min.	Standard	Max.	220V	230V	240V	
		A	B	C	Min.	Standard	Max.							
Heating operation	1 room	20	3.0	-	-	1.4	3.0	3.5	480	1020	1100	4.8	4.6	4.4
		25	3.4	-	-	1.4	3.4	4.0	480	1180	1240	5.6	5.3	5.1
		35	4.5	-	-	1.4	4.5	4.8	480	1470	1490	6.9	6.6	6.3
		50	5.8	-	-	1.4	5.8	6.0	480	1910	2260	8.8	8.4	8.0
	2 room	20 + 20	2.95	2.95	-	2.0	5.9	7.0	540	1510	2580	7.0	6.7	6.4
		20 + 25	2.67	3.33	-	2.0	6.0	7.0	540	1560	2580	7.2	6.9	6.6
		20 + 35	2.29	4.01	-	2.0	6.3	7.0	540	1650	2580	7.7	7.3	7.0
		20 + 50	1.89	4.71	-	2.0	6.6	7.0	540	1740	2580	8.0	7.7	7.4
		25 + 25	3.05	3.05	-	2.0	6.1	7.0	540	1590	2580	7.4	7.1	6.8
		25 + 35	2.67	3.73	-	2.0	6.4	7.0	540	1680	2580	7.8	7.5	7.1
		25 + 50	2.20	4.40	-	2.0	6.6	7.0	540	1740	2580	8.0	7.7	7.4
		35 + 35	3.30	3.30	-	2.0	6.6	7.0	540	1740	2580	8.0	7.7	7.4
	3 room	20 + 20 + 20	2.00	2.00	2.00	3.0	6.0	7.3	600	1340	2580	6.2	5.9	5.7
		20 + 20 + 25	1.91	1.91	2.38	3.0	6.2	7.3	600	1430	2580	6.6	6.3	6.1
		20 + 20 + 35	1.76	1.76	3.08	3.0	6.6	7.3	600	1600	2580	7.4	7.1	6.8
		20 + 25 + 25	1.83	2.29	2.29	3.0	6.4	7.3	600	1510	2580	7.0	6.7	6.4
		20 + 25 + 35	1.70	2.13	2.98	3.0	6.8	7.3	600	1660	2580	7.7	7.4	7.1
		25 + 25 + 25	2.20	2.20	2.20	3.0	6.6	7.3	600	1600	2580	7.4	7.1	6.8
		25 + 25 + 35	2.06	2.06	2.88	3.0	7.0	7.3	600	1730	2580	8.0	7.7	7.3

Indoor unit combination		Cooling capacity (kW)						Power consumption(W)			Standard current(A)			
		Room cooling capacity			Total capacity			Min.	Standard	Max.	220V	230V	240V	
		A	B	C	Min.	Standard	Max.							
Cooling operation	1 room	20	2.0	-	-	1.8	2.0	2.7	500	580	900	2.7	2.6	2.5
		25	2.5	-	-	1.8	2.5	3.2	500	760	1070	3.6	3.4	3.3
		35	3.5	-	-	1.8	3.5	3.7	500	1140	1230	5.3	5.1	4.9
		50	5.0	-	-	1.8	5.0	5.3	500	1790	2000	8.3	7.9	7.6
	2 room	20 + 20	2.00	2.00	-	3.0	4.0	5.6	570	950	1800	4.4	4.2	4.1
		20 + 25	1.91	2.39	-	3.0	4.3	5.8	570	1110	1980	5.2	4.9	4.7
		20 + 35	1.82	3.18	-	3.0	5.0	6.1	570	1490	2070	6.9	6.6	6.3
		20 + 50	1.71	4.29	-	3.0	6.0	6.3	570	2040	2150	9.4	9.0	8.6
		25 + 25	2.35	2.35	-	3.0	4.7	6.1	570	1320	2070	6.1	5.9	5.6
		25 + 35	2.21	3.09	-	3.0	5.3	6.3	570	1660	2150	7.7	7.4	7.1
		25 + 50	2.00	4.00	-	3.0	6.0	6.3	570	2040	2150	9.4	9.0	8.6
		35 + 35	3.00	3.00	-	3.0	6.0	6.3	570	2040	2150	9.4	9.0	8.6
	3 room	20 + 20 + 20	1.67	1.67	1.67	3.4	5.0	6.9	690	1120	2150	5.2	5.0	4.8
		20 + 20 + 25	1.60	1.60	2.00	3.4	5.2	6.9	690	1200	2150	5.6	5.3	5.1
		20 + 20 + 35	1.49	1.49	2.61	3.4	5.6	6.9	690	1370	2150	6.4	6.1	5.8
		20 + 25 + 25	1.54	1.93	1.93	3.4	5.4	6.9	690	1300	2150	6.0	5.8	5.5
		20 + 25 + 35	1.45	1.81	2.54	3.4	5.8	6.9	690	1470	2150	6.8	6.5	6.3
		25 + 25 + 25	1.87	1.87	1.87	3.4	5.6	6.9	690	1370	2150	6.4	6.1	5.8
25 + 25 + 35		1.76	1.76	2.47	3.4	6.0	6.9	690	1540	2150	7.1	6.8	6.5	

COMBINATIONS

SCM60ZM-S1 Table of Indoor unit combination only with SRK-ZSX type

Indoor unit combination		Heating capacity (kW)						Power consumption(W)			Standard current(A)			
		Room heating capacity			Total capacity			Min.	Standard	Max.	220V	230V	240V	
		A	B	C	Min.	Standard	Max.							
Heating operation	1 room	20	3.0	-	-	1.5	3.0	3.7	600	780	1330	3.6	3.4	3.3
		25	3.4	-	-	1.5	3.4	4.2	600	950	1510	4.4	4.2	4.0
		35	4.5	-	-	1.5	4.5	5.0	600	1270	1790	5.8	5.6	5.3
		50	5.8	-	-	1.5	5.8	6.4	600	1730	2310	7.9	7.6	7.3
		60	6.8	-	-	1.5	6.8	7.3	600	2040	2660	9.4	9.0	8.6
	2 room	20+20	3.00	3.00	-	2.1	6.0	7.3	630	1450	2100	6.7	6.4	6.1
		20+25	2.71	3.39	-	2.1	6.1	7.5	630	1520	2550	7.0	6.7	6.4
		20+35	2.36	4.14	-	2.1	6.5	7.6	630	1620	3000	7.4	7.1	6.8
		20+50	2.00	5.00	-	2.1	7.0	7.6	630	1830	3000	8.4	8.0	7.7
		20+60	1.78	5.33	-	2.1	7.1	7.6	630	1860	3000	8.5	8.2	7.8
		25+25	3.15	3.15	-	2.1	6.3	7.6	630	1580	3000	7.3	6.9	6.6
		25+35	2.79	3.91	-	2.1	6.7	7.6	630	1700	3000	7.8	7.5	7.2
		25+50	2.37	4.73	-	2.1	7.1	7.6	630	1860	3000	8.5	8.2	7.8
		25+60	2.09	5.01	-	2.1	7.1	7.6	630	1860	3000	8.5	8.2	7.8
		35+35	3.50	3.50	-	2.1	7.0	7.6	630	1830	3000	8.4	8.0	7.7
3 room	20+20+20	2.27	2.27	2.27	3.2	6.8	7.8	660	1450	3000	6.7	6.4	6.1	
	20+20+25	2.09	2.09	2.62	3.2	6.8	7.8	660	1450	3000	6.7	6.4	6.1	
	20+20+35	1.81	1.81	3.17	3.2	6.8	7.8	660	1450	3000	7.1	6.8	6.6	
	20+20+50	1.56	1.56	3.89	3.2	7.0	7.8	660	1620	3000	7.4	7.1	6.8	
	20+20+60	1.44	1.44	4.32	3.2	7.2	7.8	660	1780	3000	8.2	7.8	7.5	
	20+25+25	1.94	2.43	2.43	3.2	6.8	7.8	660	1450	3000	7.1	6.8	6.6	
	20+25+35	1.73	2.16	3.02	3.2	6.9	7.8	660	1500	3000	6.9	6.6	6.3	
	20+25+50	1.49	1.87	3.74	3.2	7.1	7.8	660	1670	3000	7.7	7.3	7.0	
	20+25+60	1.37	1.71	4.11	3.2	7.2	7.8	660	1780	3000	8.2	7.8	7.5	
	20+35+35	1.56	2.72	2.72	3.2	7.0	7.8	660	1620	3000	7.4	7.1	6.8	
	20+35+50	1.37	2.40	3.43	3.2	7.2	7.8	660	1780	3000	8.2	7.8	7.5	
	25+25+25	2.27	2.27	2.27	3.2	6.8	7.8	660	1450	3000	7.1	6.8	6.6	
	25+25+35	2.06	2.06	2.88	3.2	7.0	7.8	660	1620	3000	7.4	7.1	6.8	
	25+25+50	1.80	1.80	3.60	3.2	7.2	7.8	660	1780	3000	8.2	7.8	7.5	
	25+25+60	1.64	1.64	3.93	3.2	7.2	7.8	660	1780	3000	8.2	7.8	7.5	
25+35+35	1.87	2.62	2.62	3.2	7.1	7.8	660	1670	3000	7.7	7.3	7.0		
25+35+50	1.64	2.29	3.27	3.2	7.2	7.8	660	1780	3000	8.2	7.8	7.5		
35+35+35	2.40	2.40	2.40	3.2	7.2	7.8	660	1780	3000	8.2	7.8	7.5		

Indoor unit combination		Cooling capacity (kW)						Power consumption(W)			Standard current(A)			
		Room cooling capacity			Total capacity			Min.	Standard	Max.	220V	230V	240V	
		A	B	C	Min.	Standard	Max.							
Cooling operation	1 room	20	2.0	-	-	1.8	2.0	2.8	500	540	950	2.5	2.4	2.3
		25	2.5	-	-	1.8	2.5	3.4	500	720	1080	3.3	3.2	3.0
		35	3.5	-	-	1.8	3.5	3.9	500	1090	1240	5.0	4.8	4.6
		50	5.0	-	-	1.8	5.0	5.8	500	1780	2100	8.2	7.8	7.5
		60	6.0	-	-	1.8	6.0	6.3	500	2260	2370	10.4	9.9	9.5
	2 room	20+20	2.00	2.00	-	3.0	4.0	5.7	570	750	1750	3.4	3.3	3.2
		20+25	2.00	2.50	-	3.0	4.5	5.9	570	990	1910	4.5	4.3	4.2
		20+35	1.93	3.37	-	3.0	5.3	6.2	570	1550	2110	7.1	6.8	6.5
		20+50	1.89	4.71	-	3.0	6.6	6.9	570	2280	2390	10.5	10.0	9.6
		20+60	1.68	5.03	-	3.0	6.7	6.9	570	2320	2390	10.7	10.2	9.8
		25+25	2.45	2.45	-	3.0	4.9	6.2	570	1270	2110	5.8	5.6	5.3
		25+35	2.42	3.38	-	3.0	5.8	6.5	570	1840	2270	8.4	8.1	7.7
		25+50	2.23	4.47	-	3.0	6.7	6.9	570	2320	2390	10.7	10.2	9.8
		25+60	1.97	4.73	-	3.0	6.7	6.9	570	2320	2390	10.7	10.2	9.8
		35+35	3.30	3.30	-	3.0	6.6	6.9	570	2280	2390	10.5	10.0	9.6
3 room	20+20+20	2.00	2.00	2.00	3.6	6.0	7.5	690	1430	2390	6.6	6.3	6.0	
	20+20+25	1.85	1.85	2.80	3.6	6.0	7.5	690	1430	2390	6.6	6.3	6.0	
	20+20+35	1.60	1.60	3.60	3.6	6.0	7.5	690	1430	2390	6.8	6.5	6.2	
	20+20+50	1.40	1.40	3.50	3.6	6.3	7.5	690	1480	2390	6.8	6.5	6.2	
	20+20+60	1.28	1.28	3.84	3.6	6.4	7.5	690	1500	2390	6.9	6.6	6.3	
	20+25+25	1.69	2.11	2.11	3.6	5.9	7.5	690	1410	2390	6.5	6.2	5.9	
	20+25+35	1.53	1.91	2.67	3.6	6.1	7.5	690	1460	2390	6.7	6.4	6.1	
	20+25+50	1.35	1.68	3.37	3.6	6.4	7.5	690	1500	2390	6.9	6.6	6.3	
	20+25+60	1.26	1.57	3.77	3.6	6.6	7.5	690	1520	2390	7.0	6.7	6.4	
	20+35+35	1.40	2.45	2.45	3.6	6.3	7.5	690	1480	2390	6.8	6.5	6.2	
	20+35+50	1.26	2.20	3.14	3.6	6.6	7.5	690	1520	2390	7.0	6.7	6.4	
	25+25+25	2.00	2.00	2.00	3.6	6.0	7.5	690	1430	2390	6.8	6.5	6.2	
	25+25+35	1.79	1.79	2.51	3.6	6.1	7.5	690	1460	2390	6.7	6.4	6.1	
	25+25+50	1.60	1.60	3.20	3.6	6.4	7.5	690	1500	2390	6.9	6.6	6.3	
	25+25+60	1.52	1.52	3.65	3.6	6.7	7.5	690	1540	2390	7.1	6.8	6.5	
25+35+35	1.68	2.36	2.36	3.6	6.4	7.5	690	1500	2390	6.9	6.6	6.3		
25+35+50	1.52	2.13	3.05	3.6	6.7	7.5	690	1540	2390	7.1	6.8	6.5		
35+35+35	2.20	2.20	2.20	3.6	6.6	7.5	690	1520	2390	7.0	6.7	6.4		



MULTI-SPLIT SYSTEM

SCM60ZM-S1 Table of Indoor unit combination with other indoor unit

Indoor unit combination		Heating capacity (kW)						Power consumption(W)			Standard current(A)			
		Room heating capacity			Total capacity			Min.	Standard	Max.	220V	230V	240V	
		A	B	C	Min.	Standard	Max.							
Heating operation	1 room	20	3.0	-	-	1.5	3.0	3.5	600	970	1330	4.5	4.3	4.1
		25	3.4	-	-	1.5	3.4	4.0	600	1140	1510	5.2	5.0	4.8
		35	4.5	-	-	1.5	4.5	4.8	600	1480	1790	6.8	6.5	6.2
		50	5.8	-	-	1.5	5.8	6.1	600	1960	2310	9.0	8.6	8.2
		60	6.8	-	-	1.5	6.8	7.0	600	2250	2660	10.3	9.9	9.5
	2 room	20+20	3.00	3.00	-	2.1	6.0	7.0	630	1520	2100	7.0	6.7	6.4
		20+25	2.71	3.39	-	2.1	6.1	7.2	630	1600	2550	7.3	7.0	6.7
		20+35	2.36	4.14	-	2.1	6.5	7.3	630	1710	3000	7.9	7.5	7.2
		20+50	2.00	5.00	-	2.1	7.0	7.3	630	1940	3000	8.9	8.5	8.2
		20+60	1.78	5.33	-	2.1	7.1	7.3	630	1980	3000	9.1	8.7	8.3
		25+25	3.15	3.15	-	2.1	6.3	7.3	630	1660	3000	7.6	7.3	7.0
		25+35	2.79	3.91	-	2.1	6.7	7.3	630	1790	3000	8.2	7.9	7.5
		25+50	2.37	4.73	-	2.1	7.1	7.3	630	1980	3000	9.1	8.7	8.3
		25+60	2.09	5.01	-	2.1	7.1	7.3	630	1980	3000	9.1	8.7	8.3
		35+35	3.50	3.50	-	2.1	7.0	7.3	630	1940	3000	8.9	8.5	8.2
		35+50	2.92	4.18	-	2.1	7.1	7.3	630	1980	3000	9.1	8.7	8.3
		35+60	2.62	4.48	-	2.1	7.1	7.3	630	1980	3000	9.1	8.7	8.3
		50+50	3.55	3.55	-	2.1	7.1	7.3	630	1980	3000	9.1	8.7	8.3
		50+60	3.23	3.87	-	2.1	7.1	7.3	630	1980	3000	9.1	8.7	8.3
		3 room	20+20+20	2.27	2.27	2.27	3.2	6.8	7.6	660	1540	3000	7.1	6.8
	20+20+25		2.09	2.09	2.62	3.2	6.8	7.6	660	1540	3000	7.1	6.8	6.5
	20+20+35		1.81	1.81	3.17	3.2	6.8	7.6	660	1540	3000	7.1	6.8	6.5
	20+20+50		1.56	1.56	3.89	3.2	7.0	7.6	660	1730	3000	7.9	7.6	7.3
	20+20+60		1.44	1.44	4.32	3.2	7.2	7.6	660	1900	3000	8.7	8.3	8.0
	20+25+25		1.94	2.43	2.43	3.2	6.8	7.6	660	1540	3000	7.1	6.8	6.5
	20+25+35		1.73	2.16	3.02	3.2	6.9	7.6	660	1590	3000	7.3	7.0	6.7
	20+25+50		1.49	1.87	3.74	3.2	7.1	7.6	660	1780	3000	8.2	7.8	7.5
	20+25+60		1.37	1.71	4.11	3.2	7.2	7.6	660	1900	3000	8.7	8.3	8.0
	20+35+35		1.56	2.72	2.72	3.2	7.0	7.6	660	1730	3000	7.9	7.6	7.3
	20+35+50		1.37	2.40	3.43	3.2	7.2	7.6	660	1900	3000	8.7	8.3	8.0
25+25+25	2.27		2.27	2.27	3.2	6.8	7.6	660	1540	3000	7.1	6.8	6.5	
25+25+35	2.06		2.06	2.88	3.2	7.0	7.6	660	1730	3000	7.9	7.6	7.3	
25+25+50	1.80		1.80	3.60	3.2	7.2	7.6	660	1900	3000	8.7	8.3	8.0	
25+25+60	1.64		1.64	3.93	3.2	7.2	7.6	660	1900	3000	8.7	8.3	8.0	
25+35+35	1.87	2.62	2.62	3.2	7.1	7.6	660	1780	3000	8.2	7.8	7.5		
25+35+50	1.64	2.29	3.27	3.2	7.2	7.6	660	1900	3000	8.7	8.3	8.0		
35+35+35	2.40	2.40	2.40	3.2	7.2	7.6	660	1900	3000	8.7	8.3	8.0		

Indoor unit combination		Cooling capacity (kW)						Power consumption(W)			Standard current(A)			
		Room cooling capacity			Total capacity			Min.	Standard	Max.	220V	230V	240V	
		A	B	C	Min.	Standard	Max.							
Cooling operation	1 room	20	2.0	-	-	1.8	2.0	2.7	500	570	950	2.6	2.5	2.4
		25	2.5	-	-	1.8	2.5	3.2	500	760	1080	3.5	3.3	3.2
		35	3.5	-	-	1.8	3.5	3.7	500	1150	1240	5.3	5.1	4.8
		50	5.0	-	-	1.8	5.0	5.6	500	1860	2100	8.5	8.2	7.8
		60	6.0	-	-	1.8	6.0	6.1	500	2350	2370	10.8	10.3	9.9
	2 room	20+20	2.00	2.00	-	3.0	4.0	5.6	570	800	1750	3.7	3.5	3.4
		20+25	2.00	2.50	-	3.0	4.5	5.8	570	1050	1910	4.8	4.6	4.4
		20+35	1.93	3.37	-	3.0	5.3	6.1	570	1620	2110	7.4	7.1	6.8
		20+50	1.89	4.71	-	3.0	6.6	6.8	570	2330	2390	10.7	10.2	9.8
		20+60	1.68	5.03	-	3.0	6.7	6.8	570	2370	2390	10.9	10.4	10.0
		25+25	2.45	2.45	-	3.0	4.9	6.1	570	1340	2110	6.2	5.9	5.6
		25+35	2.42	3.38	-	3.0	5.8	6.4	570	1920	2270	8.8	8.4	8.1
		25+50	2.23	4.47	-	3.0	6.7	6.8	570	2370	2390	10.9	10.4	10.0
		25+60	1.97	4.73	-	3.0	6.7	6.8	570	2370	2390	10.9	10.4	10.0
		35+35	3.30	3.30	-	3.0	6.6	6.8	570	2330	2390	10.7	10.2	9.8
		35+50	2.76	3.94	-	3.0	6.7	6.8	570	2370	2390	10.9	10.4	10.0
		35+60	2.47	4.23	-	3.0	6.7	6.8	570	2370	2390	10.9	10.4	10.0
		50+50	3.35	3.35	-	3.0	6.7	6.8	570	2370	2390	10.9	10.4	10.0
		50+60	3.05	3.65	-	3.0	6.7	6.8	570	2370	2390	10.9	10.4	10.0
		3 room	20+20+20	2.00	2.00	2.00	3.6	6.0	7.3	690	1470	2390	6.7	6.5
	20+20+25		1.85	1.85	2.31	3.6	6.0	7.3	690	1470	2390	6.7	6.5	6.2
	20+20+35		1.60	1.60	2.80	3.6	6.0	7.3	690	1470	2390	6.7	6.5	6.2
	20+20+50		1.40	1.40	3.50	3.6	6.3	7.3	690	1520	2390	7.0	6.7	6.4
	20+20+60		1.28	1.28	3.84	3.6	6.4	7.3	690	1540	2390	7.1	6.8	6.5
	20+25+25		1.69	2.11	2.11	3.6	5.9	7.3	690	1450	2390	6.7	6.4	6.1
	20+25+35		1.53	1.91	2.67	3.6	6.1	7.3	690	1500	2390	6.9	6.6	6.3
	20+25+50		1.35	1.68	3.37	3.6	6.4	7.3	690	1540	2390	7.1	6.8	6.5
	20+25+60		1.26	1.57	3.77	3.6	6.6	7.3	690	1560	2390	7.2	6.9	6.6
	20+35+35		1.40	2.45	2.45	3.6	6.3	7.3	690	1520	2390	7.0	6.7	6.4
	20+35+50		1.26	2.20	3.14	3.6	6.6	7.3	690	1560	2390	7.2	6.9	6.6
25+25+25	2.00		2.00	2.00	3.6	6.0	7.3	690	1470	2390	6.7	6.5	6.2	
25+25+35	1.79		1.79	2.51	3.6	6.1	7.3	690	1500	2390	6.9	6.6	6.3	
25+25+50	1.60		1.60	3.20	3.6	6.4	7.3	690	1540	2390	7.1	6.8	6.5	
25+25+60	1.52		1.52	3.65	3.6	6.7	7.3	690	1580	2390	7.3	6.9	6.6	
25+35+35	1.68	2.36	2.36	3.6	6.4	7.3	690	1540	2390	7.1	6.8	6.5		
25+35+50	1.52	2.13	3.05	3.6	6.7	7.3	690	1580	2390	7.3	6.9	6.6		
35+35+35	2.20	2.20	2.20	3.6	6.6	7.3	690	1560	2390	7.2	6.9	6.6		

COMBINATIONS

SCM71ZM-S1 Table of Indoor unit combination only with SRK-ZSX type

Indoor unit combination		Heating capacity (kW)							Power consumption(W)			Standard current(A)			
		Room heating capacity				Total capacity			Min.	Standard	Max.	220V	230V	240V	
		A	B	C	D	Min.	Standard	Max.							
Heating operation	1 room	20	3.0	-	-	-	1.5	3.0	3.7	600	840	1330	3.9	3.7	3.5
		25	3.4	-	-	-	1.5	3.4	4.2	600	1000	1510	4.6	4.4	4.2
		35	4.5	-	-	-	1.5	4.5	5.0	600	1330	1790	6.1	5.8	5.6
		50	5.8	-	-	-	1.5	5.8	6.5	600	1780	2310	8.2	7.8	7.5
		60	6.8	-	-	-	1.5	6.8	7.5	600	2100	2660	9.6	9.2	8.8
	2 room	20 + 20	2.70	2.70	-	-	2.1	5.4	7.4	630	1340	1870	6.2	5.9	5.6
		20 + 25	2.62	3.28	-	-	2.1	5.9	7.7	630	1530	2130	7.0	6.7	6.4
		20 + 35	2.51	4.39	-	-	2.1	6.9	8.3	630	1910	2650	8.8	8.4	8.0
		20 + 50	2.34	5.86	-	-	2.1	8.2	8.7	630	2430	3350	11.2	10.7	10.2
		20 + 60	2.05	6.15	-	-	2.1	8.2	8.7	630	2430	3350	11.2	10.7	10.2
		25 + 25	3.20	3.20	-	-	2.1	6.4	8.1	630	1700	2480	7.8	7.5	7.2
		25 + 35	3.08	4.32	-	-	2.1	7.4	8.6	630	2090	2910	9.6	9.2	8.8
		25 + 50	2.73	5.47	-	-	2.1	8.2	8.7	630	2430	3350	11.2	10.7	10.2
		25 + 60	2.41	5.79	-	-	2.1	8.2	8.7	630	2430	3350	11.2	10.7	10.2
		35 + 35	4.10	4.10	-	-	2.1	8.2	8.7	630	2430	3350	11.2	10.7	10.2
		35 + 50	3.38	4.82	-	-	2.1	8.2	8.7	630	2430	3350	11.2	10.7	10.2
		35 + 60	3.02	5.18	-	-	2.1	8.2	8.7	630	2430	3350	11.2	10.7	10.2
		50 + 50	4.10	4.10	-	-	2.1	8.2	8.7	630	2430	3350	11.2	10.7	10.2
		50 + 60	3.73	4.47	-	-	2.1	8.2	8.7	630	2430	3350	11.2	10.7	10.2
		60 + 60	4.10	4.10	-	-	2.1	8.2	8.7	630	2430	3350	11.2	10.7	10.2
3 room	20 + 20 + 20	2.57	2.57	2.57	-	3.2	7.7	9.1	660	1830	3350	8.4	8.0	7.7	
	20 + 20 + 25	2.46	2.46	3.08	-	3.2	8.0	9.1	660	1930	3350	8.9	8.5	8.1	
	20 + 20 + 35	2.24	2.24	3.92	-	3.2	8.4	9.1	660	2060	3350	9.5	9.0	8.7	
	20 + 20 + 50	1.87	1.87	4.67	-	3.2	8.4	9.1	660	2060	3350	9.5	9.0	8.7	
	20 + 20 + 60	1.68	1.68	5.04	-	3.2	8.4	9.1	660	2060	3350	9.5	9.0	8.7	
	20 + 25 + 25	2.34	2.93	2.93	-	3.2	8.2	9.1	660	1990	3350	9.1	8.7	8.4	
	20 + 25 + 35	2.10	2.63	3.68	-	3.2	8.4	9.1	660	2060	3350	9.5	9.0	8.7	
	20 + 25 + 50	1.77	2.21	4.42	-	3.2	8.4	9.1	660	2060	3350	9.5	9.0	8.7	
	20 + 25 + 60	1.60	2.00	4.80	-	3.2	8.4	9.1	660	2060	3350	9.5	9.0	8.7	
	20 + 35 + 35	1.87	3.27	3.27	-	3.2	8.4	9.1	660	2060	3350	9.5	9.0	8.7	
	20 + 35 + 50	1.60	2.80	4.00	-	3.2	8.4	9.1	660	2060	3350	9.5	9.0	8.7	
	20 + 35 + 60	1.46	2.56	4.38	-	3.2	8.4	9.1	660	2060	3350	9.5	9.0	8.7	
	20 + 50 + 50	1.40	3.50	3.50	-	3.2	8.4	9.1	660	2060	3350	9.5	9.0	8.7	
	25 + 25 + 25	2.80	2.80	2.80	-	3.2	8.4	9.1	660	2060	3350	9.5	9.0	8.7	
	25 + 25 + 35	2.47	2.47	3.46	-	3.2	8.4	9.1	660	2060	3350	9.5	9.0	8.7	
	25 + 25 + 50	2.10	2.10	4.20	-	3.2	8.4	9.1	660	2060	3350	9.5	9.0	8.7	
	25 + 25 + 60	1.91	1.91	4.58	-	3.2	8.4	9.1	660	2060	3350	9.5	9.0	8.7	
	25 + 35 + 35	2.21	3.09	3.09	-	3.2	8.4	9.1	660	2060	3350	9.5	9.0	8.7	
	25 + 35 + 50	1.91	2.67	3.82	-	3.2	8.4	9.1	660	2060	3350	9.5	9.0	8.7	
	25 + 35 + 60	1.75	2.45	4.20	-	3.2	8.4	9.1	660	2060	3350	9.5	9.0	8.7	
25 + 50 + 50	1.68	3.36	3.36	-	3.2	8.4	9.1	660	2060	3350	9.5	9.0	8.7		
35 + 35 + 35	2.80	2.80	2.80	-	3.2	8.4	9.1	660	2060	3350	9.5	9.0	8.7		
35 + 35 + 50	2.45	2.45	3.50	-	3.2	8.4	9.1	660	2060	3350	9.5	9.0	8.7		
4 room	20 + 20 + 20 + 20	2.10	2.10	2.10	2.10	3.6	8.4	9.4	800	1960	3350	9.0	8.6	8.2	
	20 + 20 + 20 + 25	1.98	1.98	1.98	2.47	3.6	8.4	9.4	800	1960	3350	9.0	8.6	8.2	
	20 + 20 + 20 + 35	1.79	1.79	1.79	3.13	3.6	8.5	9.4	800	1980	3350	9.1	8.7	8.3	
	20 + 20 + 20 + 50	1.56	1.56	1.56	3.91	3.6	8.6	9.4	800	2000	3350	9.2	8.8	8.4	
	20 + 20 + 20 + 60	1.43	1.43	1.43	4.30	3.6	8.6	9.4	800	2000	3350	9.2	8.8	8.4	
	20 + 20 + 25 + 25	1.89	1.89	2.36	2.36	3.6	8.5	9.4	800	1980	3350	9.1	8.7	8.3	
	20 + 20 + 25 + 35	1.70	1.70	2.13	2.98	3.6	8.5	9.4	800	1980	3350	9.1	8.7	8.3	
	20 + 20 + 25 + 50	1.50	1.50	1.87	3.74	3.6	8.6	9.4	800	2000	3350	9.2	8.8	8.4	
	20 + 20 + 25 + 60	1.38	1.38	1.72	4.13	3.6	8.6	9.4	800	2000	3350	9.2	8.8	8.4	
	20 + 20 + 35 + 35	1.56	1.56	2.74	2.74	3.6	8.6	9.4	800	2000	3350	9.2	8.8	8.4	
	20 + 20 + 35 + 50	1.38	1.38	2.41	3.44	3.6	8.6	9.4	800	2000	3350	9.2	8.8	8.4	
	20 + 25 + 25 + 25	1.79	2.24	2.24	2.24	3.6	8.5	9.4	800	1980	3350	9.1	8.7	8.3	
	20 + 25 + 25 + 35	1.64	2.05	2.05	2.87	3.6	8.6	9.4	800	2000	3350	9.2	8.8	8.4	
	20 + 25 + 25 + 50	1.43	1.79	1.79	3.58	3.6	8.6	9.4	800	2000	3350	9.2	8.8	8.4	
	20 + 25 + 35 + 35	1.50	1.87	2.62	2.62	3.6	8.6	9.4	800	2000	3350	9.2	8.8	8.4	
	20 + 35 + 35 + 35	1.38	2.41	2.41	2.41	3.6	8.6	9.4	800	2000	3350	9.2	8.8	8.4	
	25 + 25 + 25 + 25	2.13	2.13	2.13	2.13	3.6	8.5	9.4	800	1980	3350	9.1	8.7	8.3	
	25 + 25 + 25 + 35	1.95	1.95	1.95	2.74	3.6	8.6	9.4	800	2000	3350	9.2	8.8	8.4	
	25 + 25 + 25 + 50	1.72	1.72	1.72	3.44	3.6	8.6	9.4	800	2000	3350	9.2	8.8	8.4	
	25 + 25 + 35 + 35	1.79	1.79	2.51	2.51	3.6	8.6	9.4	800	2000	3350	9.2	8.8	8.4	

Indoor unit combination		Cooling capacity (kW)							Power consumption(W)			Standard current(A)			
		Room cooling capacity				Total capacity			Min.	Standard	Max.	220V	230V	240V	
		A	B	C	D	Min.	Standard	Max.							
Cooling operation	1 room	20	2.0	-	-	-	1.8	2.0	2.8	480	500	950	2.3	2.2	2.1
		25	2.5	-	-	-	1.8	2.5	3.4	480	680	1080	3.1	3.0	2.9
		35	3.5	-	-	-	1.8	3.5	3.9	480	1010	1240	4.6	4.4	4.3
		50	5.0	-	-	-	1.8	5.0	6.1	480	1530	2100	7.0	6.7	6.4
		60	6.0	-	-	-	1.8	6.0	7.0	480	1880	2700	8.6	8.3	7.9
	2 room	20 + 20	2.00	2.00	-	-	3.0	4.0	6.1	550	830	1910	3.8	3.6	3.5
		20 + 25	2.00	2.50	-	-	3.0	4.5	6.4	550	1030	2060	4.7	4.5	4.3
		20 + 35	2.00	3.50	-	-	3.0	5.5	6.9	550	1390	2320	6.4	6.1	5.9
		20 + 50	1.94	4.86	-	-	3.0	6.8	7.7	550	1860	2750	8.5	8.2	7.8
		20 + 60	1.70	5.10	-	-	3.0	6.8	7.7	550	1860	2750	8.5	8.2	7.8



MULTI-SPLIT SYSTEM

Indoor unit combination		Cooling capacity (kW)							Power consumption(W)			Standard current(A)			
		Room cooling capacity				Total capacity			Min.	Standard	Max.	220V	230V	240V	
		A	B	C	D	Min.	Standard	Max.							
Cooling operation	2 room	25 + 25	2.50	2.50	-	-	3.0	5.0	6.8	550	1190	2270	5.5	5.2	5.0
		25 + 35	2.46	3.44	-	-	3.0	5.9	7.2	550	1560	2470	7.2	6.9	6.6
		25 + 50	2.27	4.53	-	-	3.0	6.8	7.7	550	1860	2750	8.5	8.2	7.8
		25 + 60	2.00	4.80	-	-	3.0	6.8	7.7	550	1860	2750	8.5	8.2	7.8
		35 + 35	3.40	3.40	-	-	3.0	6.8	7.6	550	1860	2680	8.5	8.2	7.8
		35 + 50	2.80	4.00	-	-	3.0	6.8	7.7	550	1860	2750	8.5	8.2	7.8
		35 + 60	2.51	4.29	-	-	3.0	6.8	7.7	550	1860	2750	8.5	8.2	7.8
		50 + 50	3.40	3.40	-	-	3.0	6.8	7.7	550	1860	2750	8.5	8.2	7.8
	50 + 60	3.09	3.71	-	-	3.0	6.8	7.7	550	1860	2750	8.5	8.2	7.8	
	60 + 60	3.40	3.40	-	-	3.0	6.8	7.7	550	1860	2750	8.5	8.2	7.8	
	3 room	20 + 20 + 20	2.00	2.00	2.00	-	3.7	6.0	8.2	670	1300	2750	6.0	5.7	5.5
		20 + 20 + 25	2.00	2.00	2.50	-	3.7	6.5	8.2	670	1450	2750	6.7	6.4	6.1
		20 + 20 + 35	1.84	1.84	3.22	-	3.7	6.9	8.2	670	1670	2750	7.7	7.3	7.0
		20 + 20 + 50	1.53	1.53	3.83	-	3.7	6.9	8.2	670	1670	2750	7.7	7.3	7.0
		20 + 20 + 60	1.38	1.38	4.14	-	3.7	6.9	8.2	670	1670	2750	7.7	7.3	7.0
		20 + 25 + 25	1.94	2.43	2.43	-	3.7	6.8	8.2	670	1610	2750	7.4	7.1	6.8
		20 + 25 + 35	1.73	2.16	3.02	-	3.7	6.9	8.2	670	1670	2750	7.7	7.3	7.0
		20 + 25 + 50	1.45	1.82	3.63	-	3.7	6.9	8.2	670	1670	2750	7.7	7.3	7.0
		20 + 25 + 60	1.31	1.64	3.94	-	3.7	6.9	8.2	670	1670	2750	7.7	7.3	7.0
		20 + 35 + 35	1.53	2.68	2.68	-	3.7	6.9	8.2	670	1670	2750	7.7	7.3	7.0
		20 + 35 + 50	1.31	2.30	3.29	-	3.7	6.9	8.2	670	1670	2750	7.7	7.3	7.0
		20 + 35 + 60	1.20	2.10	3.60	-	3.7	6.9	8.2	670	1670	2750	7.7	7.3	7.0
		20 + 50 + 50	1.15	2.88	2.88	-	3.7	6.9	8.2	670	1670	2750	7.7	7.3	7.0
		25 + 25 + 25	2.30	2.30	2.30	-	3.7	6.9	8.2	670	1670	2750	7.7	7.3	7.0
		25 + 25 + 35	2.03	2.03	2.84	-	3.7	6.9	8.2	670	1670	2750	7.7	7.3	7.0
		25 + 25 + 50	1.73	1.73	3.45	-	3.7	6.9	8.2	670	1670	2750	7.7	7.3	7.0
		25 + 25 + 60	1.57	1.57	3.76	-	3.7	6.9	8.2	670	1670	2750	7.7	7.3	7.0
		25 + 35 + 35	1.82	2.54	2.54	-	3.7	6.9	8.2	670	1670	2750	7.7	7.3	7.0
		25 + 35 + 50	1.57	2.20	3.14	-	3.7	6.9	8.2	670	1670	2750	7.7	7.3	7.0
		25 + 35 + 60	1.44	2.01	3.45	-	3.7	6.9	8.2	670	1670	2750	7.7	7.3	7.0
	25 + 50 + 50	1.38	2.76	2.76	-	3.7	6.9	8.2	670	1670	2750	7.7	7.3	7.0	
	35 + 35 + 35	2.30	2.30	2.30	-	3.7	6.9	8.2	670	1670	2750	7.7	7.3	7.0	
	35 + 35 + 50	2.01	2.01	2.88	-	3.7	6.9	8.2	670	1670	2750	7.7	7.3	7.0	
	4 room	20 + 20 + 20 + 20	1.73	1.73	1.73	1.73	4.4	6.9	8.8	890	1550	2750	7.1	6.8	6.5
		20 + 20 + 20 + 25	1.62	1.62	1.62	2.03	4.4	6.9	8.8	890	1550	2750	7.1	6.8	6.5
		20 + 20 + 20 + 35	1.49	1.49	1.49	2.62	4.4	7.1	8.8	890	1580	2750	7.3	6.9	6.6
20 + 20 + 20 + 50		1.29	1.29	1.29	3.23	4.4	7.1	8.8	890	1580	2750	7.3	6.9	6.6	
20 + 20 + 20 + 60		1.18	1.18	1.18	3.55	4.4	7.1	8.8	890	1580	2750	7.3	6.9	6.6	
20 + 20 + 25 + 25		1.53	1.53	1.92	1.92	4.4	6.9	8.8	890	1550	2750	7.1	6.8	6.5	
20 + 20 + 25 + 35		1.42	1.42	1.78	2.49	4.4	7.1	8.8	890	1580	2750	7.3	6.9	6.6	
20 + 20 + 25 + 50		1.23	1.23	1.54	3.09	4.4	7.1	8.8	890	1580	2750	7.3	6.9	6.6	
20 + 20 + 25 + 60		1.14	1.14	1.42	3.41	4.4	7.1	8.8	890	1580	2750	7.3	6.9	6.6	
20 + 20 + 35 + 35		1.29	1.29	2.26	2.26	4.4	7.1	8.8	890	1580	2750	7.3	6.9	6.6	
20 + 20 + 35 + 50		1.14	1.14	1.99	2.84	4.4	7.1	8.8	890	1580	2750	7.3	6.9	6.6	
20 + 25 + 25 + 25		1.49	1.87	1.87	1.87	4.4	7.1	8.8	890	1580	2750	7.3	6.9	6.6	
20 + 25 + 25 + 35		1.35	1.69	1.69	2.37	4.4	7.1	8.8	890	1580	2750	7.3	6.9	6.6	
20 + 25 + 25 + 50		1.18	1.48	1.48	2.96	4.4	7.1	8.8	890	1580	2750	7.3	6.9	6.6	
20 + 25 + 35 + 35		1.23	1.54	2.16	2.16	4.4	7.1	8.8	890	1580	2750	7.3	6.9	6.6	
20 + 35 + 35 + 35		1.14	1.99	1.99	1.99	4.4	7.1	8.8	890	1580	2750	7.3	6.9	6.6	
25 + 25 + 25 + 25		1.78	1.78	1.78	1.78	4.4	7.1	8.8	890	1580	2750	7.3	6.9	6.6	
25 + 25 + 25 + 35		1.61	1.61	1.61	2.26	4.4	7.1	8.8	890	1580	2750	7.3	6.9	6.6	
25 + 25 + 25 + 50		1.42	1.42	1.42	2.84	4.4	7.1	8.8	890	1580	2750	7.3	6.9	6.6	
25 + 25 + 35 + 35		1.48	1.48	2.07	2.07	4.4	7.1	8.8	890	1580	2750	7.3	6.9	6.6	

SCM71ZM-S1 Table of Indoor unit combination with other indoor unit

Indoor unit combination		Heating capacity (kW)							Power consumption(W)			Standard current(A)			
		Room heating capacity				Total capacity			Min.	Standard	Max.	220V	230V	240V	
		A	B	C	D	Min.	Standard	Max.							
Heating operation	1 room	20	3.0	-	-	-	1.5	3.0	3.5	600	1060	1330	4.9	4.7	4.5
		25	3.4	-	-	-	1.5	3.4	4.0	600	1220	1510	5.6	5.4	5.1
		35	4.5	-	-	-	1.5	4.5	4.8	600	1510	1790	6.9	6.6	6.4
		50	5.8	-	-	-	1.5	5.8	6.2	600	1950	2310	9.0	8.6	8.2
		60	6.8	-	-	-	1.5	6.8	7.1	600	2240	2660	10.3	9.8	9.4
	2 room	20 + 20	2.70	2.70	-	-	2.1	5.4	7.0	630	1370	1870	6.3	6.0	5.8
		20 + 25	2.62	3.28	-	-	2.1	5.9	7.3	630	1560	2130	7.2	6.9	6.6
		20 + 35	2.51	4.39	-	-	2.1	6.9	7.9	630	1950	2650	9.0	8.6	8.2
		20 + 50	2.34	5.86	-	-	2.1	8.2	8.3	630	2490	3350	11.4	10.9	10.5
		20 + 60	2.05	6.15	-	-	2.1	8.2	8.3	630	2490	3350	11.4	10.9	10.5
		25 + 25	3.20	3.20	-	-	2.1	6.4	7.7	630	1740	2480	8.0	7.6	7.3
		25 + 35	3.08	4.32	-	-	2.1	7.4	8.2	630	2130	2910	9.8	9.4	9.0
		25 + 50	2.73	5.47	-	-	2.1	8.2	8.3	630	2490	3350	11.4	10.9	10.5
		25 + 60	2.41	5.79	-	-	2.1	8.2	8.3	630	2490	3350	11.4	10.9	10.5
		35 + 35	4.10	4.10	-	-	2.1	8.2	8.3	630	2490	3350	11.4	10.9	10.5
		35 + 50	3.38	4.82	-	-	2.1	8.2	8.3	630	2490	3350	11.4	10.9	10.5
		35 + 60	3.02	5.18	-	-	2.1	8.2	8.3	630	2490	3350	11.4	10.9	10.5

COMBINATIONS

Indoor unit combination		Heating capacity (kW)							Power consumption(W)			Standard current(A)			
		Room heating capacity				Total capacity			Min.	Standard	Max.	220V	230V	240V	
		A	B	C	D	Min.	Standard	Max.							
Heating operation	2 room	50 + 50	4.10	4.10	-	-	2.1	8.2	8.3	630	2490	3350	11.4	10.9	10.5
		50 + 60	3.73	4.47	-	-	2.1	8.2	8.3	630	2490	3350	11.4	10.9	10.5
		60 + 60	4.10	4.10	-	-	2.1	8.2	8.3	630	2490	3350	11.4	10.9	10.5
	3 room	20 + 20 + 20	2.57	2.57	2.57	-	3.2	7.7	8.9	660	1870	3350	8.6	8.2	7.9
		20 + 20 + 25	2.46	2.46	3.08	-	3.2	8.0	8.9	660	1970	3350	9.0	8.7	8.3
		20 + 20 + 35	2.24	2.24	3.92	-	3.2	8.4	8.9	660	2100	3350	9.6	9.2	8.8
		20 + 20 + 50	1.87	1.87	4.67	-	3.2	8.4	8.9	660	2100	3350	9.6	9.2	8.8
		20 + 20 + 60	1.68	1.68	5.04	-	3.2	8.4	8.9	660	2100	3350	9.6	9.2	8.8
		20 + 25 + 25	2.34	2.93	2.93	-	3.2	8.2	8.9	660	2030	3350	9.3	8.9	8.5
		20 + 25 + 35	2.10	2.63	3.68	-	3.2	8.4	8.9	660	2100	3350	9.6	9.2	8.8
		20 + 25 + 50	1.77	2.21	4.42	-	3.2	8.4	8.9	660	2100	3350	9.6	9.2	8.8
		20 + 25 + 60	1.60	2.00	4.80	-	3.2	8.4	8.9	660	2100	3350	9.6	9.2	8.8
		20 + 35 + 35	1.87	3.27	3.27	-	3.2	8.4	8.9	660	2100	3350	9.6	9.2	8.8
		20 + 35 + 50	1.60	2.80	4.00	-	3.2	8.4	8.9	660	2100	3350	9.6	9.2	8.8
		20 + 35 + 60	1.46	2.56	4.38	-	3.2	8.4	8.9	660	2100	3350	9.6	9.2	8.8
		20 + 50 + 50	1.40	3.50	3.50	-	3.2	8.4	8.9	660	2100	3350	9.6	9.2	8.8
		25 + 25 + 25	2.80	2.80	2.80	-	3.2	8.4	8.9	660	2100	3350	9.6	9.2	8.8
		25 + 25 + 35	2.47	2.47	3.46	-	3.2	8.4	8.9	660	2100	3350	9.6	9.2	8.8
		25 + 25 + 50	2.10	2.10	4.20	-	3.2	8.4	8.9	660	2100	3350	9.6	9.2	8.8
		25 + 25 + 60	1.91	1.91	4.58	-	3.2	8.4	8.9	660	2100	3350	9.6	9.2	8.8
		25 + 35 + 35	2.21	3.09	3.09	-	3.2	8.4	8.9	660	2100	3350	9.6	9.2	8.8
		25 + 35 + 50	1.91	2.67	3.82	-	3.2	8.4	8.9	660	2100	3350	9.6	9.2	8.8
		25 + 35 + 60	1.75	2.45	4.20	-	3.2	8.4	8.9	660	2100	3350	9.6	9.2	8.8
		25 + 50 + 50	1.68	3.36	3.36	-	3.2	8.4	8.9	660	2100	3350	9.6	9.2	8.8
	35 + 35 + 35	2.80	2.80	2.80	-	3.2	8.4	8.9	660	2100	3350	9.6	9.2	8.8	
	35 + 35 + 50	2.45	2.45	3.50	-	3.2	8.4	8.9	660	2100	3350	9.6	9.2	8.8	
	4 room	20 + 20 + 20 + 20	2.10	2.10	2.10	2.10	3.6	8.4	9.1	800	2010	3350	9.2	8.8	8.5
		20 + 20 + 20 + 25	1.98	1.98	1.98	2.47	3.6	8.4	9.1	800	2010	3350	9.2	8.8	8.5
		20 + 20 + 20 + 35	1.79	1.79	1.79	3.13	3.6	8.5	9.1	800	2030	3350	9.3	8.9	8.5
		20 + 20 + 20 + 50	1.56	1.56	1.56	3.91	3.6	8.6	9.1	800	2050	3350	9.4	9.0	8.6
		20 + 20 + 20 + 60	1.43	1.43	1.43	4.30	3.6	8.6	9.1	800	2050	3350	9.4	9.0	8.6
		20 + 20 + 25 + 25	1.89	1.89	2.36	2.36	3.6	8.5	9.1	800	2030	3350	9.3	8.9	8.5
		20 + 20 + 25 + 35	1.70	1.70	2.13	2.98	3.6	8.5	9.1	800	2030	3350	9.3	8.9	8.5
		20 + 20 + 25 + 50	1.50	1.50	1.87	3.74	3.6	8.6	9.1	800	2050	3350	9.4	9.0	8.6
		20 + 20 + 25 + 60	1.38	1.38	1.72	4.13	3.6	8.6	9.1	800	2050	3350	9.4	9.0	8.6
		20 + 20 + 35 + 35	1.56	1.56	2.74	2.74	3.6	8.6	9.1	800	2050	3350	9.4	9.0	8.6
20 + 20 + 35 + 50		1.38	1.38	2.41	3.44	3.6	8.6	9.1	800	2050	3350	9.4	9.0	8.6	
20 + 25 + 25 + 25		1.79	2.24	2.24	2.24	3.6	8.5	9.1	800	2030	3350	9.3	8.9	8.5	
20 + 25 + 25 + 35		1.64	2.05	2.05	2.87	3.6	8.6	9.1	800	2050	3350	9.4	9.0	8.6	
20 + 25 + 25 + 50		1.43	1.79	1.79	3.58	3.6	8.6	9.1	800	2050	3350	9.4	9.0	8.6	
20 + 25 + 35 + 35		1.50	1.87	2.62	2.62	3.6	8.6	9.1	800	2050	3350	9.4	9.0	8.6	
20 + 35 + 35 + 35		1.38	2.41	2.41	2.41	3.6	8.6	9.1	800	2050	3350	9.4	9.0	8.6	
25 + 25 + 25 + 25		2.13	2.13	2.13	2.13	3.6	8.5	9.1	800	2030	3350	9.3	8.9	8.5	
25 + 25 + 25 + 35		1.95	1.95	1.95	2.74	3.6	8.6	9.1	800	2050	3350	9.4	9.0	8.6	
25 + 25 + 25 + 50	1.72	1.72	1.72	3.44	3.6	8.6	9.1	800	2050	3350	9.4	9.0	8.6		
25 + 25 + 35 + 35	1.79	1.79	2.51	2.51	3.6	8.6	9.1	800	2050	3350	9.4	9.0	8.6		

Indoor unit combination		Cooling capacity (kW)							Power consumption(W)			Standard current(A)			
		Room cooling capacity				Total capacity			Min.	Standard	Max.	220V	230V	240V	
		A	B	C	D	Min.	Standard	Max.							
Cooling operation	1 room	20	2.0	-	-	-	1.8	2.0	2.7	480	530	950	2.4	2.3	2.2
		25	2.5	-	-	-	1.8	2.5	3.2	480	730	1080	3.4	3.2	3.1
		35	3.5	-	-	-	1.8	3.5	3.7	480	1120	1240	5.1	4.9	4.7
		50	5.0	-	-	-	1.8	5.0	5.8	480	1710	2100	7.9	7.5	7.2
		60	6.0	-	-	-	1.8	6.0	6.7	480	2140	2700	9.8	9.4	9.0
	2 room	20 + 20	2.00	2.00	-	-	3.0	4.0	5.8	550	930	1910	4.3	4.1	3.9
		20 + 25	2.00	2.50	-	-	3.0	4.5	6.1	550	1170	2060	5.4	5.1	4.9
		20 + 35	2.00	3.50	-	-	3.0	5.5	6.6	550	1590	2320	7.3	7.0	6.7
		20 + 50	1.94	4.86	-	-	3.0	6.8	7.3	550	2150	2750	9.9	9.4	9.0
		20 + 60	1.70	5.10	-	-	3.0	6.8	7.3	550	2150	2750	9.9	9.4	9.0
		25 + 25	2.50	2.50	-	-	3.0	5.0	6.5	550	1360	2270	6.2	6.0	5.7
		25 + 35	2.46	3.44	-	-	3.0	5.9	6.8	550	1780	2470	8.2	7.8	7.5
		25 + 50	2.27	4.53	-	-	3.0	6.8	7.3	550	2150	2750	9.9	9.4	9.0
		25 + 60	2.00	4.80	-	-	3.0	6.8	7.3	550	2150	2750	9.9	9.4	9.0
		35 + 35	3.40	3.40	-	-	3.0	6.8	7.2	550	2150	2680	9.9	9.4	9.0
		35 + 50	2.80	4.00	-	-	3.0	6.8	7.3	550	2150	2750	9.9	9.4	9.0
		35 + 60	2.51	4.29	-	-	3.0	6.8	7.3	550	2150	2750	9.9	9.4	9.0
		50 + 50	3.40	3.40	-	-	3.0	6.8	7.3	550	2150	2750	9.9	9.4	9.0
		50 + 60	3.09	3.71	-	-	3.0	6.8	7.3	550	2150	2750	9.9	9.4	9.0
		60 + 60	3.40	3.40	-	-	3.0	6.8	7.3	550	2150	2750	9.9	9.4	9.0
	3 room	20 + 20 + 20	2.00	2.00	2.00	-	3.7	6.0	7.8	670	1450	2750	6.7	6.4	6.1
		20 + 20 + 25	2.00	2.00	2.50	-	3.7	6.5	7.8	670	1630	2750	7.5	7.2	6.9
		20 + 20 + 35	1.84	1.84	3.22	-	3.7	6.9	7.8	670	1910	2750	8.8	8.4	8.0
		20 + 20 + 50	1.53	1.53	3.83	-	3.7	6.9	7.8	670	1910	2750	8.8	8.4	8.0
		20 + 20 + 60	1.38	1.38	4.14	-	3.7	6.9	7.8	670	1910	2750	8.8	8.4	8.0
		20 + 25 + 25	1.94	2.43	2.43	-	3.7	6.8	7.8	670	1820	2750	8.4	8.0	7.7
	20 + 25 + 35	1.73	2.16	3.02	-	3.7	6.9	7.8	670	1910	2750	8.8	8.4	8.0	



MULTI-SPLIT SYSTEM

Indoor unit combination		Cooling capacity (kW)							Power consumption(W)			Standard current(A)			
		Room cooling capacity				Total capacity			Min.	Standard	Max.	220V	230V	240V	
		A	B	C	D	Min.	Standard	Max.							
Cooling operation	3 room	20 + 25 + 50	1.45	1.82	3.63	-	3.7	6.9	7.8	670	1910	2750	8.8	8.4	8.0
		20 + 25 + 60	1.31	1.64	3.94	-	3.7	6.9	7.8	670	1910	2750	8.8	8.4	8.0
		20 + 35 + 35	1.53	2.68	2.68	-	3.7	6.9	7.8	670	1910	2750	8.8	8.4	8.0
		20 + 35 + 50	1.31	2.30	3.29	-	3.7	6.9	7.8	670	1910	2750	8.8	8.4	8.0
		20 + 35 + 60	1.20	2.10	3.60	-	3.7	6.9	7.8	670	1910	2750	8.8	8.4	8.0
		20 + 50 + 50	1.15	2.88	2.88	-	3.7	6.9	7.8	670	1910	2750	8.8	8.4	8.0
		25 + 25 + 25	2.30	2.30	2.30	-	3.7	6.9	7.8	670	1910	2750	8.8	8.4	8.0
		25 + 25 + 35	2.03	2.03	2.84	-	3.7	6.9	7.8	670	1910	2750	8.8	8.4	8.0
		25 + 25 + 50	1.73	1.73	3.45	-	3.7	6.9	7.8	670	1910	2750	8.8	8.4	8.0
		25 + 25 + 60	1.57	1.57	3.76	-	3.7	6.9	7.8	670	1910	2750	8.8	8.4	8.0
		25 + 35 + 35	1.82	2.54	2.54	-	3.7	6.9	7.8	670	1910	2750	8.8	8.4	8.0
		25 + 35 + 50	1.57	2.20	3.14	-	3.7	6.9	7.8	670	1910	2750	8.8	8.4	8.0
	25 + 35 + 60	1.44	2.01	3.45	-	3.7	6.9	7.8	670	1910	2750	8.8	8.4	8.0	
	25 + 50 + 50	1.38	2.76	2.76	-	3.7	6.9	7.8	670	1910	2750	8.8	8.4	8.0	
	35 + 35 + 35	2.30	2.30	2.30	-	3.7	6.9	7.8	670	1910	2750	8.8	8.4	8.0	
	35 + 35 + 50	2.01	2.01	2.88	-	3.7	6.9	7.8	670	1910	2750	8.8	8.4	8.0	
	4 room	20 + 20 + 20 + 20	1.73	1.73	1.73	1.73	4.4	6.9	8.3	890	1750	2750	8.0	7.7	7.4
		20 + 20 + 20 + 25	1.62	1.62	1.62	2.03	4.4	6.9	8.3	890	1750	2750	8.0	7.7	7.4
		20 + 20 + 20 + 35	1.49	1.49	1.49	2.62	4.4	7.1	8.3	890	1790	2750	8.2	7.9	7.5
		20 + 20 + 20 + 50	1.29	1.29	1.29	3.23	4.4	7.1	8.3	890	1790	2750	8.2	7.9	7.5
		20 + 20 + 20 + 60	1.18	1.18	1.18	3.55	4.4	7.1	8.3	890	1790	2750	8.2	7.9	7.5
		20 + 20 + 25 + 25	1.53	1.53	1.92	1.92	4.4	6.9	8.3	890	1750	2750	8.0	7.7	7.4
		20 + 20 + 25 + 35	1.42	1.42	1.78	2.49	4.4	7.1	8.3	890	1790	2750	8.2	7.9	7.5
		20 + 20 + 25 + 50	1.23	1.23	1.54	3.09	4.4	7.1	8.3	890	1790	2750	8.2	7.9	7.5
		20 + 20 + 25 + 60	1.14	1.14	1.42	3.41	4.4	7.1	8.3	890	1790	2750	8.2	7.9	7.5
		20 + 20 + 35 + 35	1.29	1.29	2.26	2.26	4.4	7.1	8.3	890	1790	2750	8.2	7.9	7.5
		20 + 20 + 35 + 50	1.14	1.14	1.99	2.84	4.4	7.1	8.3	890	1790	2750	8.2	7.9	7.5
		20 + 25 + 25 + 25	1.49	1.87	1.87	1.87	4.4	7.1	8.3	890	1790	2750	8.2	7.9	7.5
		20 + 25 + 25 + 35	1.35	1.69	1.69	2.37	4.4	7.1	8.3	890	1790	2750	8.2	7.9	7.5
		20 + 25 + 25 + 50	1.18	1.48	1.48	2.96	4.4	7.1	8.3	890	1790	2750	8.2	7.9	7.5
		20 + 25 + 35 + 35	1.23	1.54	2.16	2.16	4.4	7.1	8.3	890	1790	2750	8.2	7.9	7.5
		20 + 35 + 35 + 35	1.14	1.99	1.99	1.99	4.4	7.1	8.3	890	1790	2750	8.2	7.9	7.5
25 + 25 + 25 + 25		1.78	1.78	1.78	1.78	4.4	7.1	8.3	890	1790	2750	8.2	7.9	7.5	
25 + 25 + 25 + 35		1.61	1.61	1.61	2.26	4.4	7.1	8.3	890	1790	2750	8.2	7.9	7.5	
25 + 25 + 25 + 50		1.42	1.42	1.42	2.84	4.4	7.1	8.3	890	1790	2750	8.2	7.9	7.5	
25 + 25 + 35 + 35		1.48	1.48	2.07	2.07	4.4	7.1	8.3	890	1790	2750	8.2	7.9	7.5	

SCM80ZM-S1 Table of Indoor unit combination only with SRK-ZSX type

Indoor unit combination		Heating capacity (kW)							Power consumption(W)			Standard current(A)			
		Room heating capacity				Total capacity			Min.	Standard	Max.	220V	230V	240V	
		A	B	C	D	Min.	Standard	Max.							
Heating operation	1 room	20	3.0	-	-	-	1.5	3.0	3.7	600	840	1330	3.9	3.7	3.5
		25	3.4	-	-	-	1.5	3.4	4.2	600	1000	1510	4.6	4.4	4.2
		35	4.5	-	-	-	1.5	4.5	5.0	600	1330	1790	6.1	5.8	5.6
		50	5.8	-	-	-	1.5	5.8	6.5	600	1780	2310	8.2	7.8	7.5
		60	6.8	-	-	-	1.5	6.8	7.5	600	2100	2660	9.6	9.2	8.8
	2 room	20 + 20	2.70	2.70	-	-	2.1	5.4	7.4	630	1340	1870	6.2	5.9	5.6
		20 + 25	2.62	3.28	-	-	2.1	5.9	7.7	630	1530	2130	7.0	6.7	6.4
		20 + 35	2.51	4.39	-	-	2.1	6.9	8.3	630	1910	2650	8.8	8.4	8.0
		20 + 50	2.37	5.93	-	-	2.1	8.3	8.8	630	2460	3430	11.3	10.8	10.4
		20 + 60	2.08	6.23	-	-	2.1	8.3	8.8	630	2460	3430	11.3	10.8	10.4
		25 + 25	3.20	3.20	-	-	2.1	6.4	8.1	630	1700	2480	7.8	7.5	7.2
		25 + 35	3.08	4.32	-	-	2.1	7.4	8.6	630	2090	2910	9.6	9.2	8.8
		25 + 50	2.77	5.53	-	-	2.1	8.3	8.8	630	2460	3430	11.3	10.8	10.4
		25 + 60	2.44	5.86	-	-	2.1	8.3	8.8	630	2460	3430	11.3	10.8	10.4
		35 + 35	4.15	4.15	-	-	2.1	8.3	8.8	630	2460	3430	11.3	10.8	10.4
		35 + 50	3.42	4.88	-	-	2.1	8.3	8.8	630	2460	3430	11.3	10.8	10.4
		35 + 60	3.06	5.24	-	-	2.1	8.3	8.8	630	2460	3430	11.3	10.8	10.4
		50 + 50	4.15	4.15	-	-	2.1	8.3	8.8	630	2460	3430	11.3	10.8	10.4
		50 + 60	3.77	4.53	-	-	2.1	8.3	8.8	630	2460	3430	11.3	10.8	10.4
		60 + 60	4.15	4.15	-	-	2.1	8.3	8.8	630	2460	3430	11.3	10.8	10.4
	3 room	20 + 20 + 20	2.57	2.57	2.57	-	3.2	7.7	9.3	660	1830	3430	8.4	8.0	7.7
		20 + 20 + 25	2.46	2.46	3.08	-	3.2	8.0	9.3	660	1930	3430	8.9	8.5	8.1
		20 + 20 + 35	2.27	2.27	3.97	-	3.2	8.5	9.3	660	2090	3430	9.6	9.2	8.8
		20 + 20 + 50	2.00	2.00	5.00	-	3.2	9.0	9.3	660	2250	3430	10.3	9.9	9.5
		20 + 20 + 60	1.80	1.80	5.40	-	3.2	9.0	9.3	660	2250	3430	10.3	9.9	9.5
		20 + 25 + 25	2.34	2.93	2.93	-	3.2	8.2	9.3	660	1990	3430	9.1	8.7	8.4
		20 + 25 + 35	2.20	2.75	3.85	-	3.2	8.8	9.3	660	2180	3430	10.0	9.6	9.2
		20 + 25 + 50	1.89	2.37	4.74	-	3.2	9.0	9.3	660	2250	3430	10.3	9.9	9.5
		20 + 25 + 60	1.71	2.14	5.14	-	3.2	9.0	9.3	660	2250	3430	10.3	9.9	9.5
		20 + 35 + 35	2.00	3.50	3.50	-	3.2	9.0	9.3	660	2250	3430	10.3	9.9	9.5
		20 + 35 + 50	1.71	3.00	4.29	-	3.2	9.0	9.3	660	2250	3430	10.3	9.9	9.5
		20 + 35 + 60	1.57	2.74	4.70	-	3.2	9.0	9.3	660	2250	3430	10.3	9.9	9.5
20 + 50 + 50	1.50	3.75	3.75	-	3.2	9.0	9.3	660	2250	3430	10.3	9.9	9.5		
20 + 50 + 60	1.38	3.46	4.15	-	3.2	9.0	9.3	660	2250	3430	10.3	9.9	9.5		

COMBINATIONS

Indoor unit combination		Heating capacity (kW)							Power consumption(W)			Standard current(A)			
		Room heating capacity				Total capacity			Min.	Standard	Max.	220V	230V	240V	
		A	B	C	D	Min.	Standard	Max.							
Heating operation	3 room	25 + 25 + 25	2.83	2.83	2.83	-	3.2	8.5	9.3	660	2090	3430	9.6	9.2	8.8
		25 + 25 + 35	2.65	2.65	3.71	-	3.2	9.0	9.3	660	2250	3430	10.3	9.9	9.5
		25 + 25 + 50	2.25	2.25	4.50	-	3.2	9.0	9.3	660	2250	3430	10.3	9.9	9.5
		25 + 25 + 60	2.05	2.05	4.91	-	3.2	9.0	9.3	660	2250	3430	10.3	9.9	9.5
		25 + 35 + 35	2.37	3.32	3.32	-	3.2	9.0	9.3	660	2250	3430	10.3	9.9	9.5
		25 + 35 + 50	2.05	2.86	4.09	-	3.2	9.0	9.3	660	2250	3430	10.3	9.9	9.5
		25 + 35 + 60	1.88	2.63	4.50	-	3.2	9.0	9.3	660	2250	3430	10.3	9.9	9.5
		25 + 50 + 50	1.80	3.60	3.60	-	3.2	9.0	9.3	660	2250	3430	10.3	9.9	9.5
		25 + 50 + 60	1.67	3.33	4.00	-	3.2	9.0	9.3	660	2250	3430	10.3	9.9	9.5
		35 + 35 + 35	3.00	3.00	3.00	-	3.2	9.0	9.3	660	2250	3430	10.3	9.9	9.5
		35 + 35 + 50	2.63	2.63	3.75	-	3.2	9.0	9.3	660	2250	3430	10.3	9.9	9.5
		35 + 35 + 60	2.42	2.42	4.15	-	3.2	9.0	9.3	660	2250	3430	10.3	9.9	9.5
	35 + 50 + 50	2.33	3.33	3.33	-	3.2	9.0	9.3	660	2250	3430	10.3	9.9	9.5	
	4 room	20 + 20 + 20 + 20	2.28	2.28	2.28	2.28	3.6	9.1	9.8	800	2220	3430	10.2	9.7	9.3
		20 + 20 + 20 + 25	2.14	2.14	2.14	2.68	3.6	9.1	9.8	800	2220	3430	10.2	9.7	9.3
		20 + 20 + 20 + 35	1.94	1.94	1.94	3.39	3.6	9.2	9.8	800	2240	3430	10.3	9.8	9.4
		20 + 20 + 20 + 50	1.67	1.67	1.67	4.18	3.6	9.2	9.8	800	2240	3430	10.3	9.8	9.4
		20 + 20 + 20 + 60	1.55	1.55	1.55	4.65	3.6	9.3	9.8	800	2260	3430	10.4	10.0	9.5
		20 + 20 + 25 + 25	2.04	2.04	2.56	2.56	3.6	9.2	9.8	800	2240	3430	10.3	9.8	9.4
		20 + 20 + 25 + 35	1.84	1.84	2.30	3.22	3.6	9.2	9.8	800	2240	3430	10.3	9.8	9.4
		20 + 20 + 25 + 50	1.62	1.62	2.02	4.04	3.6	9.3	9.8	800	2260	3430	10.4	10.0	9.5
		20 + 20 + 25 + 60	1.49	1.49	1.86	4.46	3.6	9.3	9.8	800	2260	3430	10.4	10.0	9.5
		20 + 20 + 35 + 35	1.67	1.67	2.93	2.93	3.6	9.2	9.8	800	2240	3430	10.3	9.8	9.4
		20 + 20 + 35 + 50	1.49	1.49	2.60	3.72	3.6	9.3	9.8	800	2260	3430	10.4	10.0	9.5
		20 + 20 + 35 + 60	1.38	1.38	2.41	4.13	3.6	9.3	9.8	800	2260	3430	10.4	10.0	9.5
		20 + 25 + 25 + 25	1.94	2.42	2.42	2.42	3.6	9.2	9.8	800	2240	3430	10.3	9.8	9.4
		20 + 25 + 25 + 35	1.75	2.19	2.19	3.07	3.6	9.2	9.8	800	2240	3430	10.3	9.8	9.4
		20 + 25 + 25 + 50	1.55	1.94	1.94	3.88	3.6	9.3	9.8	800	2260	3430	10.4	10.0	9.5
		20 + 25 + 25 + 60	1.43	1.79	1.79	4.29	3.6	9.3	9.8	800	2260	3430	10.4	10.0	9.5
		20 + 25 + 35 + 35	1.62	2.02	2.83	2.83	3.6	9.3	9.8	800	2260	3430	10.4	10.0	9.5
		20 + 25 + 35 + 50	1.43	1.79	2.50	3.58	3.6	9.3	9.8	800	2260	3430	10.4	10.0	9.5
		20 + 35 + 35 + 35	1.49	2.60	2.60	2.60	3.6	9.3	9.8	800	2260	3430	10.4	10.0	9.5
		25 + 25 + 25 + 25	2.30	2.30	2.30	2.30	3.6	9.2	9.8	800	2240	3430	10.3	9.8	9.4
		25 + 25 + 25 + 35	2.09	2.09	2.09	2.93	3.6	9.2	9.8	800	2240	3430	10.3	9.8	9.4
		25 + 25 + 25 + 50	1.86	1.86	1.86	3.72	3.6	9.3	9.8	800	2260	3430	10.4	10.0	9.5
		25 + 25 + 25 + 60	1.72	1.72	1.72	4.13	3.6	9.3	9.8	800	2260	3430	10.4	10.0	9.5
25 + 25 + 35 + 35		1.94	1.94	2.71	2.71	3.6	9.3	9.8	800	2260	3430	10.4	10.0	9.5	
25 + 25 + 35 + 50	1.72	1.72	2.41	3.44	3.6	9.3	9.8	800	2260	3430	10.4	10.0	9.5		
25 + 35 + 35 + 35	1.79	2.50	2.50	2.50	3.6	9.3	9.8	800	2260	3430	10.4	10.0	9.5		

Indoor unit combination		Cooling capacity (kW)							Power consumption(W)			Standard current(A)			
		Room cooling capacity				Total capacity			Min.	Standard	Max.	220V	230V	240V	
		A	B	C	D	Min.	Standard	Max.							
Cooling operation	1 room	20	2.0	-	-	-	1.8	2.0	2.8	480	500	950	2.3	2.2	2.1
		25	2.5	-	-	-	1.8	2.5	3.4	480	680	1080	3.1	3.0	2.9
		35	3.5	-	-	-	1.8	3.5	3.9	480	1010	1240	4.6	4.4	4.3
		50	5.0	-	-	-	1.8	5.0	6.1	480	1530	2100	7.0	6.7	6.4
		60	6.0	-	-	-	1.8	6.0	7.0	480	1880	2700	8.6	8.3	7.9
	2 room	20 + 20	2.00	2.00	-	-	3.0	4.0	6.1	550	830	1910	3.8	3.6	3.5
		20 + 25	2.00	2.50	-	-	3.0	4.5	6.4	550	1030	2060	4.7	4.5	4.3
		20 + 35	2.00	3.50	-	-	3.0	5.5	6.9	550	1390	2320	6.4	6.1	5.9
		20 + 50	1.97	4.93	-	-	3.0	6.9	7.9	550	1910	2830	8.8	8.4	8.0
		20 + 60	1.85	5.55	-	-	3.0	7.4	7.9	550	2090	2830	9.6	9.2	8.8
		25 + 25	2.50	2.50	-	-	3.0	5.0	6.8	550	1190	2270	5.5	5.2	5.0
		25 + 35	2.46	3.44	-	-	3.0	5.9	7.2	550	1560	2470	7.2	6.9	6.6
		25 + 50	2.47	4.93	-	-	3.0	7.4	7.9	550	2090	2830	9.6	9.2	8.8
		25 + 60	2.18	5.22	-	-	3.0	7.4	7.9	550	2090	2830	9.6	9.2	8.8
		35 + 35	3.45	3.45	-	-	3.0	6.9	7.6	550	1910	2680	8.8	8.4	8.0
		35 + 50	3.05	4.35	-	-	3.0	7.4	7.9	550	2090	2830	9.6	9.2	8.8
		35 + 60	2.73	4.67	-	-	3.0	7.4	7.9	550	2090	2830	9.6	9.2	8.8
		50 + 50	3.70	3.70	-	-	3.0	7.4	7.9	550	2090	2830	9.6	9.2	8.8
		50 + 60	3.36	4.04	-	-	3.0	7.4	7.9	550	2090	2830	9.6	9.2	8.8
		60 + 60	3.70	3.70	-	-	3.0	7.4	7.9	550	2090	2830	9.6	9.2	8.8
	3 room	20 + 20 + 20	2.00	2.00	2.00	-	3.7	6.0	8.5	670	1300	2830	6.0	5.7	5.5
		20 + 20 + 25	2.00	2.00	2.50	-	3.7	6.5	8.5	670	1450	2830	6.7	6.4	6.1
		20 + 20 + 35	1.89	1.89	3.31	-	3.7	7.1	8.5	670	1730	2830	7.9	7.6	7.3
		20 + 20 + 50	1.73	1.73	4.33	-	3.7	7.8	8.5	670	2030	2830	9.3	8.9	8.5
		20 + 20 + 60	1.56	1.56	4.68	-	3.7	7.8	8.5	670	2030	2830	9.3	8.9	8.5
		20 + 25 + 25	1.94	2.43	2.43	-	3.7	6.8	8.5	670	1610	2830	7.4	7.1	6.8
		20 + 25 + 35	1.88	2.34	3.28	-	3.7	7.5	8.5	670	1870	2830	8.6	8.2	7.9
		20 + 25 + 50	1.64	2.05	4.11	-	3.7	7.8	8.5	670	2030	2830	9.3	8.9	8.5
		20 + 25 + 60	1.49	1.86	4.46	-	3.7	7.8	8.5	670	2030	2830	9.3	8.9	8.5
		20 + 35 + 35	1.73	3.03	3.03	-	3.7	7.8	8.5	670	2030	2830	9.3	8.9	8.5
		20 + 35 + 50	1.49	2.60	3.71	-	3.7	7.8	8.5	670	2030	2830	9.3	8.9	8.5
		20 + 35 + 60	1.36	2.37	4.07	-	3.7	7.8	8.5	670	2030	2830	9.3	8.9	8.5
		20 + 50 + 50	1.30	3.25	3.25	-	3.7	7.8	8.5	670	2030	2830	9.3	8.9	8.5
		20 + 50 + 60	1.20	3.00	3.60	-	3.7	7.8	8.5	670	2030	2830	9.3	8.9	8.5



MULTI-SPLIT SYSTEM

Indoor unit combination		Cooling capacity (kW)							Power consumption(W)			Standard current(A)		
		Room cooling capacity				Total capacity			Min.	Standard	Max.	220V	230V	240V
		A	B	C	D	Min.	Standard	Max.						
3 room	25 + 25 + 25	2.37	2.37	2.37	-	3.7	7.1	8.5	670	1730	2830	7.9	7.6	7.3
	25 + 25 + 35	2.29	2.29	3.21	-	3.7	7.8	8.5	670	2030	2830	9.3	8.9	8.5
	25 + 25 + 50	1.95	1.95	3.90	-	3.7	7.8	8.5	670	2030	2830	9.3	8.9	8.5
	25 + 25 + 60	1.77	1.77	4.25	-	3.7	7.8	8.5	670	2030	2830	9.3	8.9	8.5
	25 + 35 + 35	2.05	2.87	2.87	-	3.7	7.8	8.5	670	2030	2830	9.3	8.9	8.5
	25 + 35 + 50	1.77	2.48	3.55	-	3.7	7.8	8.5	670	2030	2830	9.3	8.9	8.5
	25 + 35 + 60	1.63	2.28	3.90	-	3.7	7.8	8.5	670	2030	2830	9.3	8.9	8.5
	25 + 50 + 50	1.56	3.12	3.12	-	3.7	7.8	8.5	670	2030	2830	9.3	8.9	8.5
	25 + 50 + 60	1.44	2.89	3.47	-	3.7	7.8	8.5	670	2030	2830	9.3	8.9	8.5
	35 + 35 + 35	2.60	2.60	2.60	-	3.7	7.8	8.5	670	2030	2830	9.3	8.9	8.5
35 + 35 + 50	2.28	2.28	3.25	-	3.7	7.8	8.5	670	2030	2830	9.3	8.9	8.5	
35 + 35 + 60	2.10	2.10	3.60	-	3.7	7.8	8.5	670	2030	2830	9.3	8.9	8.5	
35 + 50 + 50	2.02	2.89	2.89	-	3.7	7.8	8.5	670	2030	2830	9.3	8.9	8.5	
Cooling operation	20 + 20 + 20 + 20	1.95	1.95	1.95	1.95	4.4	7.8	9.2	890	1920	2830	8.8	8.4	8.1
	20 + 20 + 20 + 25	1.84	1.84	1.84	2.29	4.4	7.8	9.2	890	1920	2830	8.8	8.4	8.1
	20 + 20 + 20 + 35	1.66	1.66	1.66	2.91	4.4	7.9	9.2	890	1940	2830	8.9	8.5	8.2
	20 + 20 + 20 + 50	1.44	1.44	1.44	3.59	4.4	7.9	9.2	890	1940	2830	8.9	8.5	8.2
	20 + 20 + 20 + 60	1.33	1.33	1.33	4.00	4.4	8.0	9.2	890	1950	2830	9.9	8.6	9.0
	20 + 20 + 25 + 25	1.76	1.76	2.19	2.19	4.4	7.9	9.2	890	1940	2830	8.9	8.5	8.2
	20 + 20 + 25 + 35	1.58	1.58	1.98	2.77	4.4	7.9	9.2	890	1940	2830	8.9	8.5	8.2
	20 + 20 + 25 + 50	1.37	1.37	1.72	3.43	4.4	7.9	9.2	890	1940	2830	8.9	8.5	8.2
	20 + 20 + 25 + 60	1.28	1.28	1.60	3.84	4.4	8.0	9.2	890	1950	2830	9.9	8.6	9.0
	20 + 20 + 35 + 35	1.44	1.44	2.51	2.51	4.4	7.9	9.2	890	1940	2830	8.9	8.5	8.2
	20 + 20 + 35 + 50	1.28	1.28	2.24	3.20	4.4	8.0	9.2	890	1950	2830	9.9	8.6	9.0
	20 + 20 + 35 + 60	1.19	1.19	2.07	3.56	4.4	8.0	9.2	890	1950	2830	9.9	8.6	9.0
	20 + 25 + 25 + 25	1.66	2.08	2.08	2.08	4.4	7.9	9.2	890	1940	2830	8.9	8.5	8.2
	20 + 25 + 25 + 35	1.50	1.88	1.88	2.63	4.4	7.9	9.2	890	1940	2830	8.9	8.5	8.2
	20 + 25 + 25 + 50	1.33	1.67	1.67	3.33	4.4	8.0	9.2	890	1950	2830	9.9	8.6	9.0
	20 + 25 + 25 + 60	1.23	1.54	1.54	3.69	4.4	8.0	9.2	890	1950	2830	9.9	8.6	9.0
	20 + 25 + 35 + 35	1.37	1.72	2.40	2.40	4.4	7.9	9.2	890	1940	2830	8.9	8.5	8.2
	20 + 25 + 35 + 50	1.23	1.54	2.15	3.08	4.4	8.0	9.2	890	1950	2830	9.9	8.6	9.0
	20 + 35 + 35 + 35	1.28	2.24	2.24	2.24	4.4	8.0	9.2	890	1950	2830	9.9	8.6	9.0
	25 + 25 + 25 + 25	1.98	1.98	1.98	1.98	4.4	7.9	9.2	890	1940	2830	8.9	8.5	8.2
25 + 25 + 25 + 35	1.80	1.80	1.80	2.51	4.4	7.9	9.2	890	1940	2830	8.9	8.5	8.2	
25 + 25 + 25 + 50	1.60	1.60	1.60	3.20	4.4	8.0	9.2	890	1950	2830	9.9	8.6	9.0	
25 + 25 + 25 + 60	1.48	1.48	1.48	3.56	4.4	8.0	9.2	890	1950	2830	9.9	8.6	9.0	
25 + 25 + 35 + 35	1.67	1.67	2.33	2.33	4.4	8.0	9.2	890	1950	2830	9.9	8.6	9.0	
25 + 25 + 35 + 50	1.48	1.48	2.07	2.96	4.4	8.0	9.2	890	1950	2830	9.9	8.6	9.0	
25 + 35 + 35 + 35	1.54	2.15	2.15	2.15	4.4	8.0	9.2	890	1950	2830	9.9	8.6	9.0	

SCM80ZM-S1 Table of Indoor unit combination with other indoor unit

Indoor unit combination		Heating capacity (kW)							Power consumption(W)			Standard current(A)		
		Room heating capacity				Total capacity			Min.	Standard	Max.	220V	230V	240V
		A	B	C	D	Min.	Standard	Max.						
1 room	20	3.0	-	-	-	1.5	3.0	3.5	600	1060	1330	4.9	4.7	4.5
	25	3.4	-	-	-	1.5	3.4	4.0	600	1220	1510	5.6	5.4	5.1
	35	4.5	-	-	-	1.5	4.5	4.8	600	1510	1790	6.9	6.6	6.4
	50	5.8	-	-	-	1.5	5.8	6.2	600	1950	2310	9.0	8.6	8.2
	60	6.8	-	-	-	1.5	6.8	7.1	600	2240	2660	10.3	9.8	9.4
2 room	20 + 20	2.70	2.70	-	-	2.1	5.4	7.0	630	1370	1870	6.3	6.0	5.8
	20 + 25	2.62	3.28	-	-	2.1	5.9	7.3	630	1560	2130	7.2	6.9	6.6
	20 + 35	2.51	4.39	-	-	2.1	6.9	7.9	630	1950	2650	9.0	8.6	8.2
	20 + 50	2.37	5.93	-	-	2.1	8.3	8.4	630	2510	3430	11.5	11.0	10.6
	20 + 60	2.08	6.23	-	-	2.1	8.3	8.4	630	2510	3430	11.5	11.0	10.6
	25 + 25	3.20	3.20	-	-	2.1	6.4	7.7	630	1740	2480	8.0	7.6	7.3
	25 + 35	3.08	4.32	-	-	2.1	7.4	8.2	630	2130	2910	9.8	9.4	9.0
	25 + 50	2.77	5.53	-	-	2.1	8.3	8.4	630	2510	3430	11.5	11.0	10.6
	25 + 60	2.44	5.86	-	-	2.1	8.3	8.4	630	2510	3430	11.5	11.0	10.6
	35 + 35	4.15	4.15	-	-	2.1	8.3	8.4	630	2510	3430	11.5	11.0	10.6
	35 + 50	3.42	4.88	-	-	2.1	8.3	8.4	630	2510	3430	11.5	11.0	10.6
	35 + 60	3.06	5.24	-	-	2.1	8.3	8.4	630	2510	3430	11.5	11.0	10.6
	50 + 50	4.15	4.15	-	-	2.1	8.3	8.4	630	2510	3430	11.5	11.0	10.6
50 + 60	3.77	4.53	-	-	2.1	8.3	8.4	630	2510	3430	11.5	11.0	10.6	
60 + 60	4.15	4.15	-	-	2.1	8.3	8.4	630	2510	3430	11.5	11.0	10.6	
3 room	20 + 20 + 20	2.57	2.57	2.57	-	3.2	7.7	9.1	660	1870	3430	8.6	8.2	7.9
	20 + 20 + 25	2.46	2.46	3.08	-	3.2	8.0	9.1	660	1970	3430	9.0	8.7	8.3
	20 + 20 + 35	2.27	2.27	3.97	-	3.2	8.5	9.1	660	2130	3430	9.8	9.4	9.0
	20 + 20 + 50	2.00	2.00	5.00	-	3.2	9.0	9.1	660	2300	3430	10.6	10.1	9.7
	20 + 20 + 60	1.80	1.80	5.40	-	3.2	9.0	9.1	660	2300	3430	10.6	10.1	9.7
	20 + 25 + 25	2.34	2.93	2.93	-	3.2	8.2	9.1	660	2030	3430	9.3	8.9	8.5
	20 + 25 + 35	2.20	2.75	3.85	-	3.2	8.8	9.1	660	2220	3430	10.2	9.7	9.3
	20 + 25 + 50	1.89	2.37	4.74	-	3.2	9.0	9.1	660	2300	3430	10.6	10.1	9.7
	20 + 25 + 60	1.71	2.14	5.14	-	3.2	9.0	9.1	660	2300	3430	10.6	10.1	9.7
20 + 35 + 35	2.00	3.50	3.50	-	3.2	9.0	9.1	660	2300	3430	10.6	10.1	9.7	

COMBINATIONS

Indoor unit combination		Heating capacity (kW)							Power consumption(W)			Standard current(A)			
		Room heating capacity				Total capacity			Min.	Standard	Max.	220V	230V	240V	
		A	B	C	D	Min.	Standard	Max.							
Heating operation	3 room	20 + 35 + 50	1.71	3.00	4.29	-	3.2	9.0	9.1	660	2300	3430	10.6	10.1	9.7
		20 + 35 + 60	1.57	2.74	4.70	-	3.2	9.0	9.1	660	2300	3430	10.6	10.1	9.7
		20 + 50 + 50	1.50	3.75	3.75	-	3.2	9.0	9.1	660	2300	3430	10.6	10.1	9.7
		20 + 50 + 60	1.38	3.46	4.15	-	3.2	9.0	9.1	660	2300	3430	10.6	10.1	9.7
		25 + 25 + 25	2.83	2.83	2.83	-	3.2	8.5	9.1	660	2130	3430	9.8	9.4	9.0
		25 + 25 + 35	2.65	2.65	3.71	-	3.2	9.0	9.1	660	2300	3430	10.6	10.1	9.7
		25 + 25 + 50	2.25	2.25	4.50	-	3.2	9.0	9.1	660	2300	3430	10.6	10.1	9.7
		25 + 25 + 60	2.05	2.05	4.91	-	3.2	9.0	9.1	660	2300	3430	10.6	10.1	9.7
		25 + 35 + 35	2.37	3.32	3.32	-	3.2	9.0	9.1	660	2300	3430	10.6	10.1	9.7
		25 + 35 + 50	2.05	2.86	4.09	-	3.2	9.0	9.1	660	2300	3430	10.6	10.1	9.7
		25 + 35 + 60	1.88	2.63	4.50	-	3.2	9.0	9.1	660	2300	3430	10.6	10.1	9.7
		25 + 50 + 50	1.80	3.60	3.60	-	3.2	9.0	9.1	660	2300	3430	10.6	10.1	9.7
		25 + 50 + 60	1.67	3.33	4.00	-	3.2	9.0	9.1	660	2300	3430	10.6	10.1	9.7
		35 + 35 + 35	3.00	3.00	3.00	-	3.2	9.0	9.1	660	2300	3430	10.6	10.1	9.7
		35 + 35 + 50	2.63	2.63	3.75	-	3.2	9.0	9.1	660	2300	3430	10.6	10.1	9.7
	35 + 35 + 60	2.42	2.42	4.15	-	3.2	9.0	9.1	660	2300	3430	10.6	10.1	9.7	
	35 + 50 + 50	2.33	3.33	3.33	-	3.2	9.0	9.1	660	2300	3430	10.6	10.1	9.7	
	4 room	20 + 20 + 20 + 20	2.28	2.28	2.28	2.28	3.6	9.1	9.5	800	2270	3430	10.4	10.0	9.6
		20 + 20 + 20 + 25	2.14	2.14	2.14	2.68	3.6	9.1	9.5	800	2270	3430	10.4	10.0	9.6
		20 + 20 + 20 + 35	1.94	1.94	1.94	3.39	3.6	9.2	9.5	800	2290	3430	10.5	10.1	9.6
		20 + 20 + 20 + 50	1.67	1.67	1.67	4.18	3.6	9.2	9.5	800	2290	3430	10.5	10.1	9.6
		20 + 20 + 20 + 60	1.55	1.55	1.55	4.65	3.6	9.3	9.5	800	2310	3430	10.7	10.2	9.8
		20 + 20 + 25 + 25	2.04	2.04	2.56	2.56	3.6	9.2	9.5	800	2290	3430	10.5	10.1	9.6
		20 + 20 + 25 + 35	1.84	1.84	2.30	3.22	3.6	9.2	9.5	800	2290	3430	10.5	10.1	9.6
		20 + 20 + 25 + 50	1.62	1.62	2.02	4.04	3.6	9.3	9.5	800	2310	3430	10.7	10.2	9.8
		20 + 20 + 25 + 60	1.49	1.49	1.86	4.46	3.6	9.3	9.5	800	2310	3430	10.7	10.2	9.8
		20 + 20 + 35 + 35	1.67	1.67	2.93	2.93	3.6	9.2	9.5	800	2290	3430	10.5	10.1	9.6
		20 + 20 + 35 + 50	1.49	1.49	2.60	3.72	3.6	9.3	9.5	800	2310	3430	10.7	10.2	9.8
		20 + 20 + 35 + 60	1.38	1.38	2.41	4.13	3.6	9.3	9.5	800	2310	3430	10.7	10.2	9.8
		20 + 25 + 25 + 25	1.94	2.42	2.42	2.42	3.6	9.2	9.5	800	2290	3430	10.5	10.1	9.6
		20 + 25 + 25 + 35	1.75	2.19	2.19	3.07	3.6	9.2	9.5	800	2290	3430	10.5	10.1	9.6
		20 + 25 + 25 + 50	1.55	1.94	1.94	3.88	3.6	9.3	9.5	800	2310	3430	10.7	10.2	9.8
		20 + 25 + 25 + 60	1.43	1.79	1.79	4.29	3.6	9.3	9.5	800	2310	3430	10.7	10.2	9.8
20 + 25 + 35 + 35		1.62	2.02	2.83	2.83	3.6	9.3	9.5	800	2310	3430	10.7	10.2	9.8	
20 + 25 + 35 + 50		1.43	1.79	2.50	3.58	3.6	9.3	9.5	800	2310	3430	10.7	10.2	9.8	
20 + 35 + 35 + 35		1.49	2.60	2.60	2.60	3.6	9.3	9.5	800	2310	3430	10.7	10.2	9.8	
25 + 25 + 25 + 25		2.30	2.30	2.30	2.30	3.6	9.2	9.5	800	2290	3430	10.5	10.1	9.6	
25 + 25 + 25 + 35	2.09	2.09	2.09	2.93	3.6	9.2	9.5	800	2290	3430	10.5	10.1	9.6		
25 + 25 + 25 + 50	1.86	1.86	1.86	3.72	3.6	9.3	9.5	800	2310	3430	10.7	10.2	9.8		
25 + 25 + 25 + 60	1.72	1.72	1.72	4.13	3.6	9.3	9.5	800	2310	3430	10.7	10.2	9.8		
25 + 25 + 35 + 35	1.94	1.94	2.71	2.71	3.6	9.3	9.5	800	2310	3430	10.7	10.2	9.8		
25 + 25 + 35 + 50	1.72	1.72	2.41	3.44	3.6	9.3	9.5	800	2310	3430	10.7	10.2	9.8		
25 + 35 + 35 + 35	1.79	2.50	2.50	2.50	3.6	9.3	9.5	800	2310	3430	10.7	10.2	9.8		

Indoor unit combination		Cooling capacity (kW)							Power consumption(W)			Standard current(A)			
		Room cooling capacity				Total capacity			Min.	Standard	Max.	220V	230V	240V	
		A	B	C	D	Min.	Standard	Max.							
Cooling operation	1 room	20	2.0	-	-	-	1.8	2.0	2.7	480	530	950	2.4	2.3	2.2
		25	2.5	-	-	-	1.8	2.5	3.2	480	730	1080	3.4	3.2	3.1
		35	3.5	-	-	-	1.8	3.5	3.7	480	1120	1240	5.1	4.9	4.7
		50	5.0	-	-	-	1.8	5.0	5.8	480	1710	2100	7.9	7.5	7.2
		60	6.0	-	-	-	1.8	6.0	6.7	480	2140	2700	9.8	9.4	9.0
	2 room	20 + 20	2.00	2.00	-	-	3.0	4.0	5.8	550	930	1910	4.3	4.1	3.9
		20 + 25	2.00	2.50	-	-	3.0	4.5	6.1	550	1170	2060	5.4	5.1	4.9
		20 + 35	2.00	3.50	-	-	3.0	5.5	6.6	550	1590	2320	7.3	7.0	6.7
		20 + 50	1.97	4.93	-	-	3.0	6.9	7.5	550	2200	2830	10.1	9.7	9.3
		20 + 60	1.85	5.55	-	-	3.0	7.4	7.5	550	2430	2830	11.2	10.7	10.2
		25 + 25	2.50	2.50	-	-	3.0	5.0	6.5	550	1360	2270	6.2	6.0	5.7
		25 + 35	2.46	3.44	-	-	3.0	5.9	6.8	550	1780	2470	8.2	7.8	7.5
		25 + 50	2.47	4.93	-	-	3.0	7.4	7.5	550	2430	2830	11.2	10.7	10.2
		25 + 60	2.18	5.22	-	-	3.0	7.4	7.5	550	2430	2830	11.2	10.7	10.2
		35 + 35	3.45	3.45	-	-	3.0	6.9	7.5	550	2200	2680	10.1	9.7	9.3
		35 + 50	3.05	4.35	-	-	3.0	7.4	7.5	550	2430	2830	11.2	10.7	10.2
		35 + 60	2.73	4.67	-	-	3.0	7.4	7.5	550	2430	2830	11.2	10.7	10.2
		50 + 50	3.70	3.70	-	-	3.0	7.4	7.5	550	2430	2830	11.2	10.7	10.2
		50 + 60	3.36	4.04	-	-	3.0	7.4	7.5	550	2430	2830	11.2	10.7	10.2
		60 + 60	3.70	3.70	-	-	3.0	7.4	7.5	550	2430	2830	11.2	10.7	10.2
	3 room	20 + 20 + 20	2.00	2.00	2.00	-	3.7	6.0	8.1	670	1450	2830	6.7	6.4	6.1
		20 + 20 + 25	2.00	2.00	2.50	-	3.7	6.5	8.1	670	1630	2830	7.5	7.2	6.9
		20 + 20 + 35	1.89	1.89	3.31	-	3.7	7.1	8.1	670	1950	2830	9.0	8.6	8.2
		20 + 20 + 50	1.73	1.73	4.33	-	3.7	7.8	8.1	670	2320	2830	10.7	10.2	9.8
		20 + 20 + 60	1.56	1.56	4.68	-	3.7	7.8	8.1	670	2320	2830	10.7	10.2	9.8
		20 + 25 + 25	1.94	2.43	2.43	-	3.7	6.8	8.1	670	1820	2830	8.4	8.0	7.7
		20 + 25 + 35	1.88	2.34	3.28	-	3.7	7.5	8.1	670	2130	2830	9.8	9.4	9.0
		20 + 25 + 50	1.64	2.05	4.11	-	3.7	7.8	8.1	670	2320	2830	10.7	10.2	9.8
		20 + 25 + 60	1.49	1.86	4.46	-	3.7	7.8	8.1	670	2320	2830	10.7	10.2	9.8



MULTI-SPLIT SYSTEM

Indoor unit combination		Cooling capacity (kW)							Power consumption(W)			Standard current(A)			
		Room cooling capacity				Total capacity			Min.	Standard	Max.	220V	230V	240V	
		A	B	C	D	Min.	Standard	Max.							
Cooling operation	3 room	20 + 35 + 35	1.73	3.03	3.03	-	3.7	7.8	8.1	670	2320	2830	10.7	10.2	9.8
		20 + 35 + 50	1.49	2.60	3.71	-	3.7	7.8	8.1	670	2320	2830	10.7	10.2	9.8
		20 + 35 + 60	1.36	2.37	4.07	-	3.7	7.8	8.1	670	2320	2830	10.7	10.2	9.8
		20 + 50 + 50	1.30	3.25	3.25	-	3.7	7.8	8.1	670	2320	2830	10.7	10.2	9.8
		20 + 50 + 60	1.20	3.00	3.60	-	3.7	7.8	8.1	670	2320	2830	10.7	10.2	9.8
		25 + 25 + 25	2.37	2.37	2.37	-	3.7	7.1	8.1	670	1950	2830	9.0	8.6	8.2
		25 + 25 + 35	2.29	2.29	3.21	-	3.7	7.8	8.1	670	2320	2830	10.7	10.2	9.8
		25 + 25 + 50	1.95	1.95	3.90	-	3.7	7.8	8.1	670	2320	2830	10.7	10.2	9.8
		25 + 25 + 60	1.77	1.77	4.25	-	3.7	7.8	8.1	670	2320	2830	10.7	10.2	9.8
		25 + 35 + 35	2.05	2.87	2.87	-	3.7	7.8	8.1	670	2320	2830	10.7	10.2	9.8
		25 + 35 + 50	1.77	2.48	3.55	-	3.7	7.8	8.1	670	2320	2830	10.7	10.2	9.8
		25 + 35 + 60	1.63	2.28	3.90	-	3.7	7.8	8.1	670	2320	2830	10.7	10.2	9.8
		25 + 50 + 50	1.56	3.12	3.12	-	3.7	7.8	8.1	670	2320	2830	10.7	10.2	9.8
		25 + 50 + 60	1.44	2.89	3.47	-	3.7	7.8	8.1	670	2320	2830	10.7	10.2	9.8
		35 + 35 + 35	2.60	2.60	2.60	-	3.7	7.8	8.1	670	2320	2830	10.7	10.2	9.8
35 + 35 + 50	2.28	2.28	3.25	-	3.7	7.8	8.1	670	2320	2830	10.7	10.2	9.8		
35 + 35 + 60	2.10	2.10	3.60	-	3.7	7.8	8.1	670	2320	2830	10.7	10.2	9.8		
35 + 50 + 50	2.02	2.89	2.89	-	3.7	7.8	8.1	670	2320	2830	10.7	10.2	9.8		
Cooling operation	4 room	20 + 20 + 20 + 20	1.95	1.95	1.95	1.95	4.4	7.8	8.7	890	2180	2830	9.9	9.5	9.1
		20 + 20 + 20 + 25	1.84	1.84	1.84	2.29	4.4	7.8	8.7	890	2180	2830	9.9	9.5	9.1
		20 + 20 + 20 + 35	1.66	1.66	1.66	2.91	4.4	7.9	8.7	890	2200	2830	10.0	9.6	9.2
		20 + 20 + 20 + 50	1.44	1.44	1.44	3.59	4.4	7.9	8.7	890	2200	2830	10.0	9.6	9.2
		20 + 20 + 20 + 60	1.33	1.33	1.33	4.00	4.4	8.0	8.7	890	2220	2830	10.1	9.7	9.3
		20 + 20 + 25 + 25	1.76	1.76	2.19	2.19	4.4	7.9	8.7	890	2200	2830	10.0	9.6	9.2
		20 + 20 + 25 + 35	1.58	1.58	1.98	2.77	4.4	7.9	8.7	890	2200	2830	10.0	9.6	9.2
		20 + 20 + 25 + 50	1.37	1.37	1.72	3.43	4.4	7.9	8.7	890	2200	2830	10.0	9.6	9.2
		20 + 20 + 25 + 60	1.28	1.28	1.60	3.84	4.4	8.0	8.7	890	2220	2830	10.1	9.7	9.3
		20 + 20 + 35 + 35	1.44	1.44	2.51	2.51	4.4	7.9	8.7	890	2200	2830	10.0	9.6	9.2
		20 + 20 + 35 + 50	1.28	1.28	2.24	3.20	4.4	8.0	8.7	890	2220	2830	10.1	9.7	9.3
		20 + 20 + 35 + 60	1.19	1.19	2.07	3.56	4.4	8.0	8.7	890	2220	2830	10.1	9.7	9.3
		20 + 25 + 25 + 25	1.66	2.08	2.08	2.08	4.4	7.9	8.7	890	2200	2830	10.0	9.6	9.2
		20 + 25 + 25 + 35	1.50	1.88	1.88	2.63	4.4	7.9	8.7	890	2200	2830	10.0	9.6	9.2
		20 + 25 + 25 + 50	1.33	1.67	1.67	3.33	4.4	8.0	8.7	890	2220	2830	10.1	9.7	9.3
		20 + 25 + 25 + 60	1.23	1.54	1.54	3.69	4.4	8.0	8.7	890	2220	2830	10.1	9.7	9.3
		20 + 25 + 35 + 35	1.37	1.72	2.40	2.40	4.4	7.9	8.7	890	2200	2830	10.0	9.6	9.2
		20 + 25 + 35 + 50	1.23	1.54	2.15	3.08	4.4	8.0	8.7	890	2220	2830	10.1	9.7	9.3
		20 + 35 + 35 + 35	1.28	2.24	2.24	2.24	4.4	8.0	8.7	890	2220	2830	10.1	9.7	9.3
		25 + 25 + 25 + 25	1.98	1.98	1.98	1.98	4.4	7.9	8.7	890	2200	2830	10.0	9.6	9.2
		25 + 25 + 25 + 35	1.80	1.80	1.80	2.51	4.4	7.9	8.7	890	2200	2830	10.0	9.6	9.2
		25 + 25 + 25 + 50	1.60	1.60	1.60	3.20	4.4	8.0	8.7	890	2220	2830	10.1	9.7	9.3
		25 + 25 + 25 + 60	1.48	1.48	1.48	3.56	4.4	8.0	8.7	890	2220	2830	10.1	9.7	9.3
		25 + 25 + 35 + 35	1.67	1.67	2.33	2.33	4.4	8.0	8.7	890	2220	2830	10.1	9.7	9.3
		25 + 25 + 35 + 50	1.48	1.48	2.07	2.96	4.4	8.0	8.7	890	2220	2830	10.1	9.7	9.3
25 + 35 + 35 + 35	1.54	2.15	2.15	2.15	4.4	8.0	8.7	890	2220	2830	10.1	9.7	9.3		

SCM100ZM-S Table of Indoor unit combination only with SRK-ZSX type

Indoor unit combination		Heating capacity (kW)							Power consumption(W)			Standard current(A)					
		Room heating capacity				Total capacity			Min.	Standard	Max.	220V	230V	240V			
		A	B	C	D	E	F	Min.							Standard	Max.	
Heating operation	1 room	20	3.0	-	-	-	-	1.5	3.0	3.7	700	1010	1330	4.6	4.4	4.3	
		25	3.4	-	-	-	-	1.5	3.4	4.2	700	1150	1540	5.3	5.1	4.8	
		35	4.5	-	-	-	-	1.5	4.5	5.0	700	1540	1840	7.1	6.8	6.5	
		50	5.8	-	-	-	-	1.5	5.8	6.5	700	2000	2410	9.2	8.8	8.4	
		60	6.8	-	-	-	-	1.5	6.8	7.5	700	2360	2760	10.8	10.4	9.9	
	2 room	20+20	3.00	3.00	-	-	-	-	2.1	6.0	7.4	750	1510	1460	6.9	6.6	6.4
		20+25	2.84	3.56	-	-	-	-	2.1	6.4	7.9	750	1630	2210	7.5	7.2	6.9
		20+35	2.73	4.77	-	-	-	-	2.1	7.5	8.7	750	1950	2520	9.0	8.6	8.2
		20+50	2.51	6.29	-	-	-	-	2.1	8.8	10.2	750	2380	3220	10.9	10.5	10.0
		20+60	2.45	7.35	-	-	-	-	2.1	9.8	11.2	750	2780	3620	12.8	12.2	11.7
		25+25	3.40	3.40	-	-	-	-	2.1	6.8	8.4	750	1740	2420	8.0	7.6	7.3
		25+35	3.29	4.61	-	-	-	-	2.1	7.9	9.2	750	2100	2820	9.6	9.2	8.8
		25+50	3.07	6.13	-	-	-	-	2.1	9.2	10.7	750	2580	3610	11.8	11.3	10.9
		25+60	3.00	7.20	-	-	-	-	2.1	10.2	11.7	750	2980	3790	13.7	13.1	12.5
		35+35	4.50	4.50	-	-	-	-	2.1	9.0	10.0	750	2470	3210	11.3	10.8	10.4
35+50	4.24	6.06	-	-	-	-	2.1	10.3	11.5	750	2980	3710	13.7	13.1	12.5		
35+60	4.16	7.14	-	-	-	-	2.1	11.3	12.5	750	3430	4100	15.7	15.1	14.4		
50+50	5.80	5.80	-	-	-	-	2.1	11.6	13.0	750	3580	4320	16.4	15.7	15.1		
50+60	5.45	6.55	-	-	-	-	2.1	12.0	13.5	750	3720	4520	17.1	16.3	15.7		
60+60	6.00	6.00	-	-	-	-	2.1	12.0	13.5	750	3720	4520	17.1	16.3	15.7		
3 room	20+20+20	3.00	3.00	3.00	-	-	-	3.2	9.0	11.1	780	2230	3350	10.2	9.8	9.4	
	20+20+25	2.89	2.89	3.62	-	-	-	3.2	9.4	11.6	780	2350	3550	10.8	10.3	9.9	
	20+20+35	2.80	2.80	4.90	-	-	-	3.2	10.5	12.4	780	2710	3820	12.4	11.9	11.4	
	20+20+50	2.62	2.62	6.56	-	-	-	3.2	11.8	13.5	780	3210	4190	14.7	14.1	13.5	
	20+20+60	2.40	2.40	7.20	-	-	-	3.2	12.0	13.5	780	3350	4190	15.4	14.7	14.1	
	20+25+25	2.80	3.50	3.50	-	-	-	3.2	9.8	12.1	780	2510	3720	11.5	11.0	10.6	
20+25+35	2.73	3.41	4.77	-	-	-	3.2	10.9	12.9	780	2910	3990	13.4	12.8	12.2		

COMBINATIONS

Indoor unit combination		Heating capacity (kW)									Power consumption(W)			Standard current(A)		
		Room heating capacity						Total capacity			Min.	Standard	Max.	220V	230V	240V
		A	B	C	D	E	F	Min.	Standard	Max.						
3 room	20+25+50	2.53	3.16	6.32	-	-	-	3.2	12.0	13.5	780	3350	4190	15.4	14.7	14.1
	20+25+60	2.29	2.86	6.86	-	-	-	3.2	12.0	13.5	780	3350	4190	15.4	14.7	14.1
	20+35+35	2.67	4.67	4.67	-	-	-	3.2	12.0	13.5	780	3360	4190	15.4	14.8	14.1
	20+35+50	2.29	4.00	5.71	-	-	-	3.2	12.0	13.5	780	3350	4190	15.4	14.7	14.1
	20+35+60	2.09	3.65	6.26	-	-	-	3.2	12.0	13.5	780	3340	4190	15.3	14.7	14.1
	20+50+50	2.00	5.00	5.00	-	-	-	3.2	12.0	13.5	780	3340	4190	15.3	14.7	14.1
	20+50+60	1.85	4.62	5.54	-	-	-	3.2	12.0	13.5	780	3340	4190	15.3	14.7	14.1
	20+60+60	1.71	5.14	5.14	-	-	-	3.2	12.0	13.5	780	3330	4190	15.3	14.6	14.0
	25+25+25	3.40	3.40	3.40	-	-	-	3.2	10.2	12.6	780	2710	3880	12.4	11.9	11.4
	25+25+35	3.32	3.32	4.65	-	-	-	3.2	11.3	13.4	780	3110	4120	14.3	13.7	13.1
	25+25+50	3.00	3.00	6.00	-	-	-	3.2	12.0	13.5	780	3350	4190	15.4	14.7	14.1
	25+25+60	2.73	2.73	6.55	-	-	-	3.2	12.0	13.5	780	3350	4190	15.4	14.7	14.1
	25+35+35	3.16	4.42	4.42	-	-	-	3.2	12.0	13.5	780	3350	4190	15.4	14.7	14.1
	25+35+50	2.73	3.82	5.45	-	-	-	3.2	12.0	13.5	780	3350	4190	15.4	14.7	14.1
	25+35+60	2.50	3.50	6.00	-	-	-	3.2	12.0	13.5	780	3340	4190	15.3	14.7	14.1
	25+50+50	2.40	4.80	4.80	-	-	-	3.2	12.0	13.5	780	3340	4190	15.3	14.7	14.1
	25+50+60	2.22	4.44	5.33	-	-	-	3.2	12.0	13.5	780	3330	4190	15.3	14.6	14.0
	25+60+60	2.07	4.97	4.97	-	-	-	3.2	12.0	13.5	780	3330	4190	15.3	14.6	14.0
	35+35+35	4.00	4.00	4.00	-	-	-	3.2	12.0	13.5	780	3350	4190	15.4	14.7	14.1
	35+35+50	3.50	3.50	5.00	-	-	-	3.2	12.0	13.5	780	3340	4190	15.3	14.7	14.1
35+35+60	3.23	3.23	5.54	-	-	-	3.2	12.0	13.5	780	3340	4190	15.3	14.7	14.1	
35+50+50	3.11	4.44	4.44	-	-	-	3.2	12.0	13.5	780	3330	4190	15.3	14.6	14.0	
35+50+60	2.90	4.14	4.97	-	-	-	3.2	12.0	13.5	780	3330	4190	15.3	14.6	14.0	
35+60+60	2.71	4.65	4.65	-	-	-	3.2	12.0	13.5	780	3320	4190	15.2	14.6	14.0	
50+50+50	4.00	4.00	4.00	-	-	-	3.2	12.0	13.5	780	3330	4190	15.3	14.6	14.0	
50+50+60	3.75	3.75	4.50	-	-	-	3.2	12.0	13.5	780	3320	4190	15.2	14.6	14.0	
4 room	20+20+20+20	3.00	3.00	3.00	3.00	-	-	3.6	12.0	13.5	950	3230	3840	14.7	14.1	13.5
	20+20+20+25	2.82	2.82	2.82	3.53	-	-	3.6	12.0	13.5	950	3230	3840	14.7	14.1	13.5
	20+20+20+35	2.53	2.53	2.53	4.42	-	-	3.6	12.0	13.5	950	3230	3840	14.7	14.1	13.5
	20+20+20+50	2.18	2.18	2.18	5.45	-	-	3.6	12.0	13.5	950	3220	3840	14.7	14.0	13.4
	20+20+20+60	2.00	2.00	2.00	6.00	-	-	3.6	12.0	13.5	950	3220	3840	14.7	14.0	13.4
	20+20+25+25	2.67	2.67	3.33	3.33	-	-	3.6	12.0	13.5	950	3230	3840	14.7	14.1	13.5
	20+20+25+35	2.40	2.40	3.00	4.20	-	-	3.6	12.0	13.5	950	3220	3840	14.7	14.0	13.4
	20+20+25+50	2.09	2.09	2.61	5.22	-	-	3.6	12.0	13.5	950	3220	3840	14.7	14.0	13.4
	20+20+25+60	1.92	1.92	2.40	5.76	-	-	3.6	12.0	13.5	950	3340	3840	15.2	14.5	13.9
	20+20+35+35	2.18	2.18	3.82	3.82	-	-	3.6	12.0	13.5	950	3220	3840	14.7	14.0	13.4
	20+20+35+50	1.92	1.92	3.36	4.80	-	-	3.6	12.0	13.5	950	3340	3840	15.2	14.5	13.9
	20+20+35+60	1.78	1.78	3.11	5.33	-	-	3.6	12.0	13.5	950	3210	3840	14.6	14.0	13.4
	20+20+50+50	1.71	1.71	4.29	4.29	-	-	3.6	12.0	13.5	950	3210	3840	14.6	14.0	13.4
	20+20+50+60	1.60	1.60	4.00	4.80	-	-	3.6	12.0	13.5	950	3210	3840	14.6	14.0	13.4
	20+20+60+60	1.50	1.50	4.50	4.50	-	-	3.6	12.0	13.5	950	3200	3840	14.6	13.9	13.3
	20+25+25+25	2.53	3.16	3.16	3.16	-	-	3.6	12.0	13.5	950	3230	3840	14.7	14.1	13.5
	20+25+25+35	2.29	2.86	2.86	4.00	-	-	3.6	12.0	13.5	950	3220	3840	14.7	14.0	13.4
	20+25+25+50	2.00	2.50	2.50	5.00	-	-	3.6	12.0	13.5	950	3220	3840	14.7	14.0	13.4
	20+25+25+60	1.85	2.31	2.31	5.54	-	-	3.6	12.0	13.5	950	3340	3840	15.2	14.5	13.9
	20+25+35+35	2.09	2.61	3.65	3.65	-	-	3.6	12.0	13.5	950	3220	3840	14.7	14.0	13.4
	20+25+35+50	1.85	2.31	3.23	4.62	-	-	3.6	12.0	13.5	950	3340	3840	15.2	14.5	13.9
	20+25+35+60	1.71	2.14	3.00	5.14	-	-	3.6	12.0	13.5	950	3210	3840	14.6	14.0	13.4
	20+25+50+50	1.66	2.07	4.14	4.14	-	-	3.6	12.0	13.5	950	3210	3840	14.6	14.0	13.4
	20+25+50+60	1.55	1.94	3.87	4.65	-	-	3.6	12.0	13.5	950	3200	3840	14.6	13.9	13.3
	20+35+35+35	1.92	3.36	3.36	3.36	-	-	3.6	12.0	13.5	950	3340	3840	15.2	14.5	13.9
	20+35+35+50	1.71	3.00	3.00	4.29	-	-	3.6	12.0	13.5	950	3210	3840	14.6	14.0	13.4
	20+35+35+60	1.60	2.80	2.80	4.80	-	-	3.6	12.0	13.5	950	3210	3840	14.6	14.0	13.4
	20+35+50+50	1.55	2.71	3.87	3.87	-	-	3.6	12.0	13.5	950	3200	3840	14.6	13.9	13.3
	25+25+25+25	3.00	3.00	3.00	3.00	-	-	3.6	12.0	13.5	950	3220	3840	14.7	14.0	13.4
	25+25+25+35	2.73	2.73	2.73	3.82	-	-	3.6	12.0	13.5	950	3220	3840	14.7	14.0	13.4
	25+25+25+50	2.40	2.40	2.40	4.80	-	-	3.6	12.0	13.5	950	3340	3840	15.2	14.5	13.9
	25+25+25+60	2.22	2.22	2.22	5.33	-	-	3.6	12.0	13.5	950	3210	3840	14.6	14.0	13.4
	25+25+35+35	2.50	2.50	3.50	3.50	-	-	3.6	12.0	13.5	950	3220	3840	14.7	14.0	13.4
	25+25+35+50	2.22	2.22	3.11	4.44	-	-	3.6	12.0	13.5	950	3210	3840	14.6	14.0	13.4
	25+25+35+60	2.07	2.07	2.90	4.97	-	-	3.6	12.0	13.5	950	3210	3840	14.6	14.0	13.4
	25+25+50+50	2.00	2.00	4.00	4.00	-	-	3.6	12.0	13.5	950	3210	3840	14.6	14.0	13.4
	25+25+50+60	1.88	1.88	3.75	4.50	-	-	3.6	12.0	13.5	950	3200	3840	14.6	13.9	13.3
	25+35+35+35	2.31	3.23	3.23	3.23	-	-	3.6	12.0	13.5	950	3340	3840	15.2	14.5	13.9
	25+35+35+50	2.07	2.90	2.90	4.14	-	-	3.6	12.0	13.5	950	3210	3840	14.6	14.0	13.4
	25+35+35+60	1.94	2.71	2.71	4.65	-	-	3.6	12.0	13.5	950	3200	3840	14.6	13.9	13.3
25+35+50+50	1.88	2.63	3.75	3.75	-	-	3.6	12.0	13.5	950	3200	3840	14.6	13.9	13.3	
35+35+35+35	3.00	3.00	3.00	3.00	-	-	3.6	12.0	13.5	950	3210	3840	14.6	14.0	13.4	
35+35+35+50	2.71	2.71	2.71	3.87	-	-	3.6	12.0	13.5	950	3200	3840	14.6	13.9	13.3	
5 room	20+20+20+20+20	2.40	2.40	2.40	2.40	2.40	-	4.0	12.0	13.5	1050	2930	3400	13.3	12.8	12.2
	20+20+20+20+25	2.29	2.29	2.29	2.29	2.86	-	4.0	12.0	13.5	1050	2920	3400	13.3	12.7	12.2
	20+20+20+20+35	2.09	2.09	2.09	2.09	3.65	-	4.0	12.0	13.5	1050	2920	3400	13.3	12.7	12.2
	20+20+20+20+50	1.85	1.85	1.85	1.85	4.62	-	4.0	12.0	13.5	1050	2910	3400	13.2	12.7	12.1
	20+20+20+20+60	1.71	1.71	1.71	1.71	5.14	-	4.0	12.0	13.5	1050	2910	3400	13.2	12.7	12.1
	20+20+20+25+25	2.18	2.18													



MULTI-SPLIT SYSTEM

Indoor unit combination		Heating capacity (kW)									Power consumption(W)			Standard current(A)			
		Room heating capacity						Total capacity			Min.	Standard	Max.	220V	230V	240V	
		A	B	C	D	E	F	Min.	Standard	Max.							
Heating operation	5 room	20+20+20+25+60	1.66	1.66	1.66	2.07	4.97	-	4.0	12.0	13.5	1050	2910	3400	13.2	12.7	12.1
		20+20+20+35+35	1.85	1.85	1.85	3.23	3.23	-	4.0	12.0	13.5	1050	2910	3400	13.2	12.7	12.1
		20+20+20+35+50	1.66	1.66	1.66	2.90	4.14	-	4.0	12.0	13.5	1050	2910	3400	13.2	12.7	12.1
		20+20+20+35+60	1.55	1.55	1.55	2.71	4.65	-	4.0	12.0	13.5	1050	2900	3400	13.2	12.6	12.1
		20+20+20+50+50	1.50	1.50	1.50	3.75	3.75	-	4.0	12.0	13.5	1050	2900	3400	13.2	12.6	12.1
		20+20+25+25+25	2.09	2.09	2.61	2.61	2.61	-	4.0	12.0	13.5	1050	2920	3400	13.3	12.7	12.2
		20+20+25+25+35	1.92	1.92	2.40	2.40	3.36	-	4.0	12.0	13.5	1050	2910	3400	13.2	12.7	12.1
		20+20+25+25+50	1.71	1.71	2.14	2.14	4.29	-	4.0	12.0	13.5	1050	2910	3400	13.2	12.7	12.1
		20+20+25+25+60	1.60	1.60	2.00	2.00	4.80	-	4.0	12.0	13.5	1050	2910	3400	13.2	12.7	12.1
		20+20+25+35+35	1.78	1.78	2.22	3.11	3.11	-	4.0	12.0	13.5	1050	2910	3400	13.2	12.7	12.1
		20+20+25+35+50	1.60	1.60	2.00	2.80	4.00	-	4.0	12.0	13.5	1050	2910	3400	13.2	12.7	12.1
		20+20+25+35+60	1.50	1.50	1.88	2.63	4.50	-	4.0	12.0	13.5	1050	2900	3400	13.2	12.6	12.1
		20+20+35+35+35	1.66	1.66	2.90	2.90	2.90	-	4.0	12.0	13.5	1050	2910	3400	13.2	12.7	12.1
		20+20+35+35+50	1.50	1.50	2.63	2.63	3.75	-	4.0	12.0	13.5	1050	2900	3400	13.2	12.6	12.1
		20+25+25+25+25	2.00	2.50	2.50	2.50	2.50	-	4.0	12.0	13.5	1050	2920	3400	13.3	12.7	12.2
		20+25+25+25+35	1.85	2.31	2.31	2.31	3.23	-	4.0	12.0	13.5	1050	2910	3400	13.2	12.7	12.1
		20+25+25+25+50	1.66	2.07	2.07	2.07	4.14	-	4.0	12.0	13.5	1050	2910	3400	13.2	12.7	12.1
		20+25+25+25+60	1.55	1.94	1.94	1.94	4.65	-	4.0	12.0	13.5	1050	2900	3400	13.2	12.6	12.1
		20+25+25+35+35	1.71	2.14	2.14	3.00	3.00	-	4.0	12.0	13.5	1050	2910	3400	13.2	12.7	12.1
		20+25+25+35+50	1.55	1.94	1.94	2.71	3.87	-	4.0	12.0	13.5	1050	2900	3400	13.2	12.6	12.1
		20+25+35+35+35	1.60	2.00	2.80	2.80	2.80	-	4.0	12.0	13.5	1050	2910	3400	13.2	12.7	12.1
		20+35+35+35+35	1.50	2.63	2.63	2.63	2.63	-	4.0	12.0	13.5	1050	2900	3400	13.2	12.6	12.1
		25+25+25+25+25	2.40	2.40	2.40	2.40	2.40	-	4.0	12.0	13.5	1050	2910	3400	13.2	12.7	12.1
		25+25+25+25+35	2.22	2.22	2.22	2.22	3.11	-	4.0	12.0	13.5	1050	2910	3400	13.2	12.7	12.1
		25+25+25+25+50	2.00	2.00	2.00	2.00	4.00	-	4.0	12.0	13.5	1050	2910	3400	13.2	12.7	12.1
25+25+25+25+60	1.88	1.88	1.88	1.88	4.50	-	4.0	12.0	13.5	1050	2900	3400	13.2	12.6	12.1		
25+25+25+35+35	2.07	2.07	2.07	2.90	2.90	-	4.0	12.0	13.5	1050	2910	3400	13.2	12.7	12.1		
25+25+25+35+50	1.88	1.88	1.88	2.63	3.75	-	4.0	12.0	13.5	1050	2900	3400	13.2	12.6	12.1		
25+25+35+35+35	1.94	1.94	2.71	2.71	2.71	-	4.0	12.0	13.5	1050	2900	3400	13.2	12.6	12.1		

Indoor unit combination		Cooling capacity (kW)									Power consumption(W)			Standard current(A)			
		Room cooling capacity						Total capacity			Min.	Standard	Max.	220V	230V	240V	
		A	B	C	D	E	F	Min.	Standard	Max.							
Cooling operation	1 room	20	2.0	-	-	-	-	-	1.8	2.0	2.8	650	750	1100	3.4	3.3	3.2
		25	2.5	-	-	-	-	-	1.8	2.5	3.4	650	950	1350	4.4	4.2	4.0
		35	3.5	-	-	-	-	-	1.8	3.5	3.9	650	1400	1600	6.4	6.1	5.9
		50	5.0	-	-	-	-	-	1.8	5.0	6.1	650	2000	2500	9.2	8.8	8.4
		60	6.0	-	-	-	-	-	1.8	6.0	7.0	650	2450	3000	11.2	10.8	10.3
	2 room	20+20	2.00	2.00	-	-	-	-	3.0	4.0	5.6	740	910	1460	4.2	4.0	3.8
		20+25	2.00	2.50	-	-	-	-	3.0	4.5	6.2	740	1050	1820	4.8	4.6	4.4
		20+35	2.00	3.50	-	-	-	-	3.0	5.5	6.7	740	1430	2020	6.6	6.3	6.0
		20+50	2.00	5.00	-	-	-	-	3.0	7.0	8.9	740	2180	2820	10.0	9.6	9.2
		20+60	2.00	6.00	-	-	-	-	3.0	8.0	9.8	740	2530	3360	11.6	11.1	10.6
		25+25	2.50	2.50	-	-	-	-	3.0	5.0	6.8	740	1350	2200	6.2	5.9	5.7
		25+35	2.50	3.50	-	-	-	-	3.0	6.0	7.3	740	1720	2320	7.9	7.6	7.2
		25+50	2.50	5.00	-	-	-	-	3.0	7.5	9.5	740	2350	3220	10.8	10.3	9.9
		25+60	2.50	6.00	-	-	-	-	3.0	8.5	9.8	740	2680	3360	12.3	11.8	11.3
		35+35	3.50	3.50	-	-	-	-	3.0	7.0	7.8	740	2180	2820	10.0	9.6	9.2
		35+50	3.50	5.00	-	-	-	-	3.0	8.5	10.0	740	2680	3620	12.3	11.8	11.3
		35+60	3.50	6.00	-	-	-	-	3.0	9.5	10.9	740	3120	3990	14.3	13.7	13.1
		50+50	5.00	5.00	-	-	-	-	3.0	10.0	12.0	740	3350	4400	15.4	14.7	14.1
		50+60	4.55	5.45	-	-	-	-	3.0	10.0	12.0	740	3350	4400	15.4	14.7	14.1
		60+60	5.00	5.00	-	-	-	-	3.0	10.0	12.0	740	3340	4400	15.3	14.7	14.1
	3 room	20+20+20	2.00	2.00	2.00	-	-	-	3.7	6.0	8.4	880	1460	2560	6.7	6.4	6.1
		20+20+25	2.00	2.00	2.50	-	-	-	3.7	6.5	9.0	880	1650	2700	7.6	7.2	6.9
		20+20+35	2.00	2.00	3.50	-	-	-	3.7	7.5	9.5	880	1980	3120	9.1	8.7	8.3
		20+20+50	2.00	2.00	5.00	-	-	-	3.7	9.0	11.7	880	2600	4120	11.9	11.4	10.9
		20+20+60	2.00	2.00	6.00	-	-	-	3.7	10.0	12.0	880	3120	4250	14.3	13.7	13.1
		20+25+25	2.00	2.50	2.50	-	-	-	3.7	7.0	9.6	880	1850	3210	8.5	8.1	7.8
		20+25+35	2.00	2.50	3.50	-	-	-	3.7	8.0	10.1	880	2320	3630	10.7	10.2	9.8
		20+25+50	2.00	2.50	5.00	-	-	-	3.7	9.5	12.0	880	2980	4250	13.7	13.1	12.5
		20+25+60	1.90	2.38	5.71	-	-	-	3.7	10.0	12.0	880	3120	4250	14.3	13.7	13.1
		20+35+35	2.00	3.50	3.50	-	-	-	3.7	9.0	10.6	880	2780	3750	12.8	12.2	11.7
		20+35+50	1.90	3.33	4.76	-	-	-	3.7	10.0	12.0	880	3120	4250	14.3	13.7	13.1
		20+35+60	1.74	3.04	5.22	-	-	-	3.7	10.0	12.0	880	3110	4250	14.3	13.7	13.1
		20+50+50	1.67	4.17	4.17	-	-	-	3.7	10.0	12.0	880	3110	4250	14.3	13.7	13.1
		20+50+60	1.54	3.85	4.62	-	-	-	3.7	10.0	12.0	880	3110	4250	14.3	13.7	13.1
		20+60+60	1.43	4.29	4.29	-	-	-	3.7	10.0	12.0	880	3100	4250	14.2	13.6	13.0
		25+25+25	2.50	2.50	2.50	-	-	-	3.7	7.5	10.2	880	2030	3640	9.3	8.9	8.5
		25+25+35	2.50	2.50	3.50	-	-	-	3.7	8.5	10.7	880	2520	3900	11.6	11.1	10.6
		25+25+50	2.50	2.50	5.00	-	-	-	3.7	10.0	12.0	880	3120	4250	14.3	13.7	13.1
		25+25+60	2.27	2.27	5.45	-	-	-	3.7	10.0	12.0	880	3120	4250	14.3	13.7	13.1
		25+35+35	2.50	3.50	3.50	-	-	-	3.7	9.5	11.2	880	2980	3990	13.7	13.1	12.5
		25+35+50	2.27	3.18	4.55	-	-	-	3.7	10.0	12.0	880	3120	4250	14.3	13.7	13.1
		25+35+60	2.08	2.92	5.00	-	-	-	3.7	10.0	12.0	880	3110	4250	14.3	13.7	13.1
		25+50+50	2.00	4.00	4.00	-	-	-	3.7	10.0	12.0	880	3110	4250	14.3	13.7	13.1
		25+50+60	1.85	3.70	4.44	-	-	-	3.7	10.0	12.0	880	3100	4250	14.2	13.6	13.0

COMBINATIONS

Indoor unit combination		Cooling capacity (kW)									Power consumption(W)			Standard current(A)			
		Room cooling capacity						Total capacity			Min.	Standard	Max.	220V	230V	240V	
		A	B	C	D	E	F	Min.	Standard	Max.							
Cooling operation	3 room	25+60+60	1.72	4.14	4.14	-	-	-	3.7	10.0	12.0	880	3100	4250	14.2	13.6	13.0
		35+35+35	3.33	3.33	3.33	-	-	-	3.7	10.0	11.7	880	3120	4180	14.3	13.7	13.1
		35+35+50	2.92	2.92	4.17	-	-	-	3.7	10.0	12.0	880	3110	4250	14.3	13.7	13.1
		35+35+60	2.69	2.69	4.62	-	-	-	3.7	10.0	12.0	880	3110	4250	14.3	13.7	13.1
		35+50+50	2.59	3.70	3.70	-	-	-	3.7	10.0	12.0	880	3100	4250	14.2	13.6	13.0
		35+50+60	2.41	3.45	4.14	-	-	-	3.7	10.0	12.0	880	3100	4250	14.2	13.6	13.0
		35+60+60	2.26	3.87	3.87	-	-	-	3.7	10.0	12.0	880	3090	4250	14.2	13.6	13.0
		50+50+50	3.33	3.33	3.33	-	-	-	3.7	10.0	12.0	880	3100	4250	14.2	13.6	13.0
		50+50+60	3.13	3.13	3.75	-	-	-	3.7	10.0	12.0	880	3090	4250	14.2	13.6	13.0
	4 room	20+20+20+20	2.00	2.00	2.00	2.00	-	-	4.4	8.0	11.2	1100	2050	3680	9.3	8.9	8.6
		20+20+20+25	2.00	2.00	2.00	2.50	-	-	4.4	8.5	11.8	1100	2320	3890	10.6	10.1	9.7
		20+20+20+35	2.00	2.00	2.00	3.50	-	-	4.4	9.5	12.0	1100	2820	4050	12.8	12.3	11.8
		20+20+20+50	1.82	1.82	1.82	4.55	-	-	4.4	10.0	12.0	1100	3020	4050	13.7	13.1	12.6
		20+20+20+60	1.67	1.67	1.67	5.00	-	-	4.4	10.0	12.0	1100	3020	4050	13.7	13.1	12.6
		20+20+25+25	2.00	2.00	2.50	2.50	-	-	4.4	9.0	12.0	1100	2520	4050	11.5	11.0	10.5
		20+20+25+35	2.00	2.00	2.50	3.50	-	-	4.4	10.0	12.0	1100	3030	4050	13.8	13.2	12.6
		20+20+25+50	1.74	1.74	2.17	4.35	-	-	4.4	10.0	12.0	1100	3020	4050	13.7	13.1	12.6
		20+20+25+60	1.60	1.60	2.00	4.80	-	-	4.4	10.0	12.0	1100	3010	4050	13.7	13.1	12.6
		20+20+35+35	1.82	1.82	3.18	3.18	-	-	4.4	10.0	12.0	1100	3020	4050	13.7	13.1	12.6
		20+20+35+50	1.60	1.60	2.80	4.00	-	-	4.4	10.0	12.0	1100	3010	4050	13.7	13.1	12.6
		20+20+35+60	1.48	1.48	2.59	4.44	-	-	4.4	10.0	12.0	1100	3010	4050	13.7	13.1	12.6
		20+20+50+50	1.43	1.43	3.57	3.57	-	-	4.4	10.0	12.0	1100	3010	4050	13.7	13.1	12.6
		20+20+50+60	1.33	1.33	3.33	4.00	-	-	4.4	10.0	12.0	1100	3000	4050	13.7	13.1	12.5
		20+20+60+60	1.25	1.25	3.75	3.75	-	-	4.4	10.0	12.0	1100	2990	4050	13.6	13.0	12.5
		20+25+25+25	2.00	2.50	2.50	2.50	-	-	4.4	9.5	12.0	1100	2820	4050	12.8	12.3	11.8
		20+25+25+35	1.90	2.38	2.38	3.33	-	-	4.4	10.0	12.0	1100	3030	4050	13.8	13.2	12.6
		20+25+25+50	1.67	2.08	2.08	4.17	-	-	4.4	10.0	12.0	1100	3020	4050	13.7	13.1	12.6
		20+25+25+60	1.54	1.92	1.92	4.62	-	-	4.4	10.0	12.0	1100	3010	4050	13.7	13.1	12.6
		20+25+35+35	1.74	2.17	3.04	3.04	-	-	4.4	10.0	12.0	1100	3020	4050	13.7	13.1	12.6
		20+25+35+50	1.54	1.92	2.69	3.85	-	-	4.4	10.0	12.0	1100	3010	4050	13.7	13.1	12.6
		20+25+35+60	1.43	1.79	2.50	4.29	-	-	4.4	10.0	12.0	1100	3010	4050	13.7	13.1	12.6
		20+25+50+50	1.38	1.72	3.45	3.45	-	-	4.4	10.0	12.0	1100	3000	4050	13.7	13.1	12.5
		20+25+50+60	1.29	1.61	3.23	3.87	-	-	4.4	10.0	12.0	1100	3000	4050	13.7	13.1	12.5
20+25+60+60		1.21	1.52	3.64	3.64	-	-	4.4	10.0	12.0	1100	2990	4050	13.6	13.0	12.5	
20+35+35+35		1.60	2.80	2.80	2.80	-	-	4.4	10.0	12.0	1100	3010	4050	13.7	13.1	12.6	
20+35+35+50		1.43	2.50	2.50	3.57	-	-	4.4	10.0	12.0	1100	3010	4050	13.7	13.1	12.6	
20+35+35+60		1.33	2.33	2.33	4.00	-	-	4.4	10.0	12.0	1100	3000	4050	13.7	13.1	12.5	
20+35+50+50		1.29	2.26	3.23	3.23	-	-	4.4	10.0	12.0	1100	3000	4050	13.7	13.1	12.5	
25+25+25+25		2.50	2.50	2.50	2.50	-	-	4.4	10.0	12.0	1100	3030	4050	13.8	13.2	12.6	
25+25+25+35		2.27	2.27	2.27	3.18	-	-	4.4	10.0	12.0	1100	3020	4050	13.7	13.1	12.6	
25+25+25+50		2.00	2.00	2.00	4.00	-	-	4.4	10.0	12.0	1100	3010	4050	13.7	13.1	12.6	
25+25+25+60		1.85	1.85	1.85	4.44	-	-	4.4	10.0	12.0	1100	3010	4050	13.7	13.1	12.6	
25+25+35+35		2.08	2.08	2.92	2.92	-	-	4.4	10.0	12.0	1100	3020	4050	13.7	13.1	12.6	
25+25+35+50		1.85	1.85	2.59	3.70	-	-	4.4	10.0	12.0	1100	3010	4050	13.7	13.1	12.6	
25+25+35+60		1.72	1.72	2.41	4.14	-	-	4.4	10.0	12.0	1100	3000	4050	13.7	13.1	12.5	
25+25+50+50		1.67	1.67	3.33	3.33	-	-	4.4	10.0	12.0	1100	3000	4050	13.7	13.1	12.5	
25+25+50+60		1.56	1.56	3.13	3.75	-	-	4.4	10.0	12.0	1100	2990	4050	13.6	13.0	12.5	
25+35+35+35		1.92	2.69	2.69	2.69	-	-	4.4	10.0	12.0	1100	3010	4050	13.7	13.1	12.6	
25+35+35+50		1.72	2.41	2.41	3.45	-	-	4.4	10.0	12.0	1100	3000	4050	13.7	13.1	12.5	
25+35+35+60		1.61	2.26	2.26	3.87	-	-	4.4	10.0	12.0	1100	3000	4050	13.7	13.1	12.5	
25+35+50+50		1.56	2.19	3.13	3.13	-	-	4.4	10.0	12.0	1100	2990	4050	13.6	13.0	12.5	
35+35+35+35		2.50	2.50	2.50	2.50	-	-	4.4	10.0	12.0	1100	3010	4050	13.7	13.1	12.6	
35+35+35+50		2.26	2.26	2.26	3.23	-	-	4.4	10.0	12.0	1100	3000	4050	13.7	13.1	12.5	
5 room		20+20+20+20+20	2.00	2.00	2.00	2.00	2.00	-	5.1	10.0	12.0	1210	2860	4030	13.0	12.4	11.9
	20+20+20+20+25	1.90	1.90	1.90	1.90	2.38	-	5.1	10.0	12.0	1210	2860	4030	13.0	12.4	11.9	
	20+20+20+20+35	1.74	1.74	1.74	1.74	3.04	-	5.1	10.0	12.0	1210	2850	4030	13.0	12.4	11.9	
	20+20+20+20+50	1.54	1.54	1.54	1.54	3.85	-	5.1	10.0	12.0	1210	2840	4030	12.9	12.4	11.8	
	20+20+20+20+60	1.43	1.43	1.43	1.43	4.29	-	5.1	10.0	12.0	1210	2840	4030	12.9	12.4	11.8	
	20+20+20+25+25	1.82	1.82	1.82	2.27	2.27	-	5.1	10.0	12.0	1210	2860	4030	13.0	12.4	11.9	
	20+20+20+25+35	1.67	1.67	1.67	2.08	2.92	-	5.1	10.0	12.0	1210	2850	4030	13.0	12.4	11.9	
	20+20+20+25+50	1.48	1.48	1.48	1.85	3.70	-	5.1	10.0	12.0	1210	2840	4030	12.9	12.4	11.8	
	20+20+20+25+60	1.38	1.38	1.38	1.72	4.14	-	5.1	10.0	12.0	1210	2840	4030	12.9	12.4	11.8	
	20+20+20+35+35	1.54	1.54	1.54	2.69	2.69	-	5.1	10.0	12.0	1210	2840	4030	12.9	12.4	11.8	
	20+20+20+35+50	1.38	1.38	1.38	2.41	3.45	-	5.1	10.0	12.0	1210	2840	4030	12.9	12.4	11.8	
	20+20+20+35+60	1.29	1.29	1.29	2.26	3.87	-	5.1	10.0	12.0	1210	2830	4030	12.9	12.3	11.8	
	20+20+20+50+50	1.25	1.25	1.25	3.13	3.13	-	5.1	10.0	12.0	1210	2830	4030	12.9	12.3	11.8	
	20+20+25+25+25	1.74	1.74	2.17	2.17	2.17	-	5.1	10.0	12.0	1210	2850	4030	13.0	12.4	11.9	
	20+20+25+25+35	1.60	1.60	2.00	2.00	2.80	-	5.1	10.0	12.0	1210	2850	4030	13.0	12.4	11.9	
	20+20+25+25+50	1.43	1.43	1.79	1.79	3.57	-	5.1	10.0	12.0	1210	2840	4030	12.9	12.4	11.8	
	20+20+25+25+60	1.33	1.33	1.67	1.67	4.00	-	5.1	10.0	12.0	1210	2840	4030	12.9	12.4	11.8	
	20+20+25+35+35	1.48	1.48	1.85	2.59	2.59	-	5.1	10.0	12.0	1210	2840	4030	12.9	12.4	11.8	
	20+20+25+35+50	1.33	1.33	1.67	2.33	3.33	-	5.1	10.0	12.0	1210	2840	4030	12.9	12.4	11.8	
	20+20+25+35+60	1.25	1.25	1.56	2.19	3.75	-	5.1	10.0	12.0	1210	2830	4030	12.9	12.3	11.8	
	20+20+35+35+35	1.38	1.38	2.41	2.41	2.41	-	5.1	10.0	12.0	1210	2840	4030	12.9	12.4	11.8	
20+20+35+35+50	1.25	1.25	2.19	2.19	3.13	-	5.1	10.0	12.0	1210	2830	4030	12.9	12.3	11.8		
20+25+25+25+25	1.67	2.08	2.08	2.08	2.08	-	5.1	10.0	12.0	1210	2850	4030	13.0	12.4	11.9		
20+25+25+25+35	1.54	1.92	1.92	1.92	2.69	-	5.1	10.0	12.0	1210	2840	4030	12.9	12.4	11.8		



MULTI-SPLIT SYSTEM

Indoor unit combination		Cooling capacity (kW)									Power consumption(W)			Standard current(A)			
		Room cooling capacity						Total capacity			Min.	Standard	Max.	220V	230V	240V	
		A	B	C	D	E	F	Min.	Standard	Max.							
Cooling operation	5 room	20+25+25+25+50	1.38	1.72	1.72	1.72	3.45	-	5.1	10.0	12.0	1210	2840	4030	12.9	12.4	11.8
		20+25+25+25+60	1.29	1.61	1.61	1.61	3.87	-	5.1	10.0	12.0	1210	2830	4030	12.9	12.3	11.8
		20+25+25+35+35	1.43	1.79	1.79	2.50	2.50	-	5.1	10.0	12.0	1210	2840	4030	12.9	12.4	11.8
		20+25+25+35+50	1.29	1.61	1.61	2.26	3.23	-	5.1	10.0	12.0	1210	2830	4030	12.9	12.3	11.8
		20+25+35+35+35	1.33	1.67	2.33	2.33	2.33	-	5.1	10.0	12.0	1210	2840	4030	12.9	12.4	11.8
		20+35+35+35+35	1.25	2.19	2.19	2.19	2.19	-	5.1	10.0	12.0	1210	2830	4030	12.9	12.3	11.8
		25+25+25+25+25	2.00	2.00	2.00	2.00	2.00	-	5.1	10.0	12.0	1210	2850	4030	13.0	12.4	11.9
		25+25+25+25+35	1.85	1.85	1.85	1.85	2.59	-	5.1	10.0	12.0	1210	2840	4030	12.9	12.4	11.8
		25+25+25+25+50	1.67	1.67	1.67	1.67	3.33	-	5.1	10.0	12.0	1210	2840	4030	12.9	12.4	11.8
		25+25+25+25+60	1.56	1.56	1.56	1.56	3.75	-	5.1	10.0	12.0	1210	2830	4030	12.9	12.3	11.8
25+25+25+35+35	1.72	1.72	1.72	2.41	2.41	-	5.1	10.0	12.0	1210	2840	4030	12.9	12.4	11.8		
25+25+25+35+50	1.56	1.56	1.56	2.19	3.13	-	5.1	10.0	12.0	1210	2830	4030	12.9	12.3	11.8		
25+25+35+35+35	1.61	1.61	2.26	2.26	2.26	-	5.1	10.0	12.0	1210	2830	4030	12.9	12.3	11.8		

SCM100ZM-S Table of Indoor unit combination with other indoor unit

Indoor unit combination		Heating capacity (kW)									Power consumption(W)			Standard current(A)			
		Room heating capacity						Total capacity			Min.	Standard	Max.	220V	230V	240V	
		A	B	C	D	E	F	Min.	Standard	Max.							
Cooling operation	1 room	20	3.0	-	-	-	-	-	1.5	3.0	3.6	700	1220	1330	5.6	5.4	5.1
		25	3.4	-	-	-	-	-	1.5	3.4	4.1	700	1265	1540	5.8	5.6	5.3
		35	4.5	-	-	-	-	-	1.5	4.5	4.9	700	1650	1840	7.6	7.2	6.9
		50	5.8	-	-	-	-	-	1.5	5.8	6.4	700	2120	2410	9.7	9.3	8.9
		60	6.8	-	-	-	-	-	1.5	6.8	7.4	700	2500	2760	11.5	11.0	10.5
71	8.0	-	-	-	-	-	1.5	8.0	8.1	700	3020	3090	13.9	13.3	12.7		
Cooling operation	2 room	20+20	3.00	3.00	-	-	-	-	2.1	6.0	7.2	750	1540	1860	7.1	6.8	6.5
		20+25	2.84	3.56	-	-	-	-	2.1	6.4	7.7	750	1660	2210	7.6	7.3	7.0
		20+35	2.73	4.77	-	-	-	-	2.1	7.5	8.5	750	1990	2520	9.1	8.7	8.4
		20+50	2.51	6.29	-	-	-	-	2.1	8.8	10.0	750	2430	3220	11.2	10.7	10.2
		20+60	2.45	7.35	-	-	-	-	2.1	9.8	11.0	750	2840	3620	13.0	12.5	12.0
		20+71	2.42	8.58	-	-	-	-	2.1	11.0	11.6	750	2840	3620	13.0	12.5	12.0
		25+25	3.40	3.40	-	-	-	-	2.1	6.8	8.2	750	1770	2420	8.1	7.8	7.4
		25+35	3.29	4.61	-	-	-	-	2.1	7.9	9.0	750	2140	2820	9.8	9.4	9.0
		25+50	3.07	6.13	-	-	-	-	2.1	9.2	10.5	750	2630	3610	12.1	11.6	11.1
		25+60	3.00	7.20	-	-	-	-	2.1	10.2	11.5	750	3040	3790	14.0	13.4	12.8
		25+71	2.97	8.43	-	-	-	-	2.1	11.4	12.1	750	3440	4250	15.8	15.1	14.5
		35+35	4.50	4.50	-	-	-	-	2.1	9.0	9.8	750	2520	3210	11.6	11.1	10.6
		35+50	4.24	6.06	-	-	-	-	2.1	10.3	11.3	750	3040	3710	14.0	13.4	12.8
		35+60	4.16	7.14	-	-	-	-	2.1	11.3	12.3	750	3420	4320	15.7	15.0	14.4
		35+71	3.96	8.04	-	-	-	-	2.1	12.0	12.9	750	4030	4690	18.5	17.7	17.0
		50+50	5.80	5.80	-	-	-	-	2.1	11.6	12.8	750	3660	4620	16.8	16.1	15.4
		50+60	5.45	6.55	-	-	-	-	2.1	12.0	13.3	750	4030	4920	18.5	17.7	17.0
		50+71	4.96	7.04	-	-	-	-	2.1	12.0	13.3	750	4030	4920	18.5	17.7	17.0
		60+60	6.00	6.00	-	-	-	-	2.1	12.0	13.3	750	4030	4920	18.5	17.7	17.0
		60+71	5.50	6.50	-	-	-	-	2.1	12.0	13.3	750	4030	4920	18.5	17.7	17.0
71+71	6.00	6.00	-	-	-	-	2.1	12.0	13.3	750	4030	4920	18.5	17.7	17.0		
Cooling operation	3 room	20+20+20	3.00	3.00	3.00	-	-	-	3.2	9.0	10.9	780	2270	3350	10.4	10.0	9.6
		20+20+25	2.89	2.89	3.62	-	-	-	3.2	9.4	11.4	780	2400	3550	11.0	10.5	10.1
		20+20+35	2.80	2.80	4.90	-	-	-	3.2	10.5	12.2	780	2760	3820	12.7	12.1	11.6
		20+20+50	2.62	2.62	6.56	-	-	-	3.2	11.8	13.3	780	3270	4290	15.0	14.4	13.8
		20+20+60	2.40	2.40	7.20	-	-	-	3.2	12.0	13.3	780	3420	4290	15.7	15.0	14.4
		20+20+71	2.16	2.16	7.68	-	-	-	3.2	12.0	13.3	780	3410	4290	15.7	15.0	14.4
		20+25+25	2.80	3.50	3.50	-	-	-	3.2	9.8	11.9	780	2560	3720	11.8	11.2	10.8
		20+25+35	2.73	3.41	4.77	-	-	-	3.2	10.9	12.7	780	2970	3990	13.6	13.0	12.5
		20+25+50	2.53	3.16	6.32	-	-	-	3.2	12.0	13.3	780	3420	4290	15.7	15.0	14.4
		20+25+60	2.29	2.86	6.86	-	-	-	3.2	12.0	13.3	780	3420	4290	15.7	15.0	14.4
		20+25+71	2.07	2.59	7.34	-	-	-	3.2	12.0	13.3	780	3410	4290	15.7	15.0	14.4
		20+35+35	2.67	4.67	4.67	-	-	-	3.2	12.0	13.3	780	3420	4290	15.7	15.0	14.4
		20+35+50	2.29	4.00	5.71	-	-	-	3.2	12.0	13.3	780	3420	4290	15.7	15.0	14.4
		20+35+60	2.09	3.65	6.26	-	-	-	3.2	12.0	13.3	780	3410	4290	15.7	15.0	14.4
		20+35+71	1.90	3.33	6.76	-	-	-	3.2	12.0	13.3	780	3410	4290	15.7	15.0	14.4
		20+50+50	2.00	5.00	5.00	-	-	-	3.2	12.0	13.3	780	3410	4290	15.7	15.0	14.4
		20+50+60	1.85	4.62	5.54	-	-	-	3.2	12.0	13.3	780	3400	4290	15.6	14.9	14.3
		20+50+71	1.70	4.26	6.04	-	-	-	4.2	12.0	13.3	780	3390	4290	15.6	14.9	14.3
		20+60+60	1.71	5.14	5.14	-	-	-	5.2	12.0	13.3	780	3390	4290	15.6	14.9	14.3
		20+60+71	1.59	4.77	5.64	-	-	-	6.2	12.0	13.3	780	3390	4290	15.6	14.9	14.3
		25+25+25	3.40	3.40	3.40	-	-	-	3.2	10.2	12.4	780	2760	3880	12.7	12.1	11.6
		25+25+35	3.32	3.32	4.65	-	-	-	3.2	11.3	13.2	780	3170	4120	14.6	13.9	13.3
		25+25+50	3.00	3.00	6.00	-	-	-	3.2	12.0	13.3	780	3420	4290	15.7	15.0	14.4
		25+25+60	2.73	2.73	6.55	-	-	-	3.2	12.0	13.3	780	3410	4290	15.7	15.0	14.4
		25+25+71	2.48	2.48	7.04	-	-	-	3.2	12.0	13.3	780	3410	4290	15.7	15.0	14.4
		25+35+35	3.16	4.42	4.42	-	-	-	3.2	12.0	13.3	780	3420	4290	15.7	15.0	14.4
		25+35+50	2.73	3.82	5.45	-	-	-	3.2	12.0	13.3	780	3410	4290	15.7	15.0	14.4
		25+35+60	2.50	3.50	6.00	-	-	-	3.2	12.0	13.3	780	3410	4290	15.7	15.0	14.4
		25+35+71	2.29	3.21	6.50	-	-	-	4.2	12.0	13.3	780	3400	4290	15.6	14.9	14.3
		25+50+50	2.40	4.80	4.80	-	-	-	3.2	12.0	13.3	780	3410	4290	15.7	15.0	14.4
25+50+60	2.22	4.44	5.33	-	-	-	3.2	12.0	13.3	780	3400	4290	15.6	14.9	14.3		

COMBINATIONS

Indoor unit combination		Heating capacity (kW)									Power consumption(W)			Standard current(A)		
		Room heating capacity						Total capacity			Min.	Standard	Max.	220V	230V	240V
		A	B	C	D	E	F	Min.	Standard	Max.						
3 room	25+50+71	2.05	4.11	5.84	-	-	-	3.2	12.0	13.3	780	3390	4290	15.6	14.9	14.3
	25+60+60	2.07	4.97	4.97	-	-	-	3.2	12.0	13.3	780	3390	4290	15.6	14.9	14.3
	25+60+71	1.92	4.62	5.46	-	-	-	3.2	12.0	13.3	780	3390	4290	15.6	14.9	14.3
	35+35+35	4.00	4.00	4.00	-	-	-	3.2	12.0	13.3	780	3420	4290	15.7	15.0	14.4
	35+35+50	3.50	3.50	5.00	-	-	-	3.2	12.0	13.3	780	3410	4290	15.7	15.0	14.4
	35+35+60	3.23	3.23	5.54	-	-	-	3.2	12.0	13.3	780	3400	4290	15.6	14.9	14.3
	35+35+71	2.98	2.98	6.04	-	-	-	3.2	12.0	13.3	780	3390	4290	15.6	14.9	14.3
	35+50+50	3.11	4.44	4.44	-	-	-	3.2	12.0	13.3	780	3400	4290	15.6	14.9	14.3
	35+50+60	2.90	4.14	4.97	-	-	-	3.2	12.0	13.3	780	3390	4290	15.6	14.9	14.3
	35+50+71	2.69	3.85	5.46	-	-	-	3.2	12.0	13.3	780	3390	4290	15.6	14.9	14.3
	35+60+60	2.71	4.65	4.65	-	-	-	3.2	12.0	13.3	780	3390	4290	15.6	14.9	14.3
	50+50+50	4.00	4.00	4.00	-	-	-	3.2	12.0	13.3	780	3390	4290	15.6	14.9	14.3
50+50+60	3.75	3.75	4.50	-	-	-	3.2	12.0	13.3	780	3380	4290	15.5	14.8	14.2	
4 room	20+20+20+20	3.00	3.00	3.00	3.00	-	-	3.6	12.0	13.3	950	3270	3920	14.9	14.2	13.6
	20+20+20+25	2.82	2.82	2.82	3.53	-	-	3.6	12.0	13.3	950	3270	3920	14.9	14.2	13.6
	20+20+20+35	2.53	2.53	2.53	4.42	-	-	3.6	12.0	13.3	950	3270	3920	14.9	14.2	13.6
	20+20+20+50	2.18	2.18	2.18	5.45	-	-	3.6	12.0	13.3	950	3260	3920	14.8	14.2	13.6
	20+20+20+60	2.00	2.00	2.00	6.00	-	-	3.6	12.0	13.3	950	3250	3920	14.8	14.1	13.6
	20+20+20+71	1.83	1.83	1.83	6.50	-	-	3.6	12.0	13.3	950	3250	3920	14.6	14.0	13.4
	20+20+25+25	2.67	2.67	3.33	3.33	-	-	3.6	12.0	13.3	950	3270	3920	14.9	14.2	13.6
	20+20+25+35	2.40	2.40	3.00	4.20	-	-	3.6	12.0	13.3	950	3260	3920	14.8	14.2	13.6
	20+20+25+50	2.09	2.09	2.61	5.22	-	-	3.6	12.0	13.3	950	3260	3920	14.8	14.2	13.6
	20+20+25+60	1.92	1.92	2.40	5.76	-	-	3.6	12.0	13.3	950	3250	3920	14.8	14.1	13.6
	20+20+25+71	1.76	1.76	2.21	6.26	-	-	3.6	12.0	13.3	950	3250	3920	14.8	14.1	13.6
	20+20+35+35	2.18	2.18	3.82	3.82	-	-	3.6	12.0	13.3	950	3260	3920	14.8	14.2	13.6
	20+20+35+50	1.92	1.92	3.36	4.80	-	-	3.6	12.0	13.3	950	3250	3920	14.8	14.1	13.6
	20+20+35+60	1.78	1.78	3.11	5.33	-	-	3.6	12.0	13.3	950	3250	3920	14.8	14.1	13.6
	20+20+35+71	1.64	1.64	2.88	5.84	-	-	3.6	12.0	13.3	950	3240	3920	14.7	14.1	13.5
	20+20+50+50	1.71	1.71	4.29	4.29	-	-	3.6	12.0	13.3	950	3240	3920	14.7	14.1	13.5
	20+20+50+60	1.60	1.60	4.00	4.80	-	-	3.6	12.0	13.3	950	3240	3920	14.7	14.1	13.5
	20+20+60+60	1.50	1.50	4.50	4.50	-	-	3.6	12.0	13.3	950	3240	3920	14.7	14.1	13.5
	20+25+25+25	2.53	3.16	3.16	3.16	-	-	3.6	12.0	13.3	950	3270	3920	14.9	14.2	13.6
	20+25+25+35	2.29	2.86	2.86	4.00	-	-	3.6	12.0	13.3	950	3260	3920	14.8	14.2	13.6
	20+25+25+50	2.00	2.50	2.50	5.00	-	-	3.6	12.0	13.3	950	3250	3920	14.8	14.1	13.6
	20+25+25+60	1.85	2.31	2.31	5.54	-	-	3.6	12.0	13.3	950	3250	3920	14.8	14.1	13.6
	20+25+25+71	1.70	2.13	2.13	6.04	-	-	3.6	12.0	13.3	950	3240	3920	14.7	14.1	13.5
	20+25+35+35	2.09	2.61	3.65	3.65	-	-	3.6	12.0	13.3	950	3260	3920	14.8	14.2	13.6
	20+25+35+50	1.85	2.31	3.23	4.62	-	-	3.6	12.0	13.3	950	3250	3920	14.8	14.1	13.6
	20+25+35+60	1.71	2.14	3.00	5.14	-	-	3.6	12.0	13.3	950	3240	3920	14.7	14.1	13.5
	20+25+35+71	1.59	1.99	2.78	5.64	-	-	3.6	12.0	13.3	950	3240	3920	14.7	14.1	13.5
	20+25+50+50	1.66	2.07	4.14	4.14	-	-	3.6	12.0	13.3	950	3240	3920	14.7	14.1	13.5
	20+25+50+60	1.55	1.94	3.87	4.65	-	-	3.6	12.0	13.3	950	3240	3920	14.7	14.1	13.5
	20+35+35+35	1.92	3.36	3.36	3.36	-	-	3.6	12.0	13.3	950	3250	3920	14.8	14.1	13.6
	20+35+35+50	1.71	3.00	3.00	4.29	-	-	3.6	12.0	13.3	950	3240	3920	14.7	14.1	13.5
	20+35+35+60	1.60	2.80	2.80	4.80	-	-	3.6	12.0	13.3	950	3240	3920	14.7	14.1	13.5
	20+35+50+50	1.55	2.71	3.87	3.87	-	-	3.6	12.0	13.3	950	3240	3920	14.7	14.1	13.5
	25+25+25+25	3.00	3.00	3.00	3.00	-	-	3.6	12.0	13.3	950	3260	3920	14.8	14.2	13.6
	25+25+25+35	2.73	2.73	2.73	3.82	-	-	3.6	12.0	13.3	950	3260	3920	14.8	14.2	13.6
	25+25+25+50	2.40	2.40	2.40	4.80	-	-	3.6	12.0	13.3	950	3250	3920	14.8	14.1	13.6
	25+25+25+60	2.22	2.22	2.22	5.33	-	-	3.6	12.0	13.3	950	3250	3920	14.8	14.1	13.6
	25+25+25+71	2.05	2.05	2.05	5.84	-	-	3.6	12.0	13.3	950	3240	3920	14.7	14.1	13.5
	25+25+35+35	2.50	2.50	3.50	3.50	-	-	3.6	12.0	13.3	950	3250	3920	14.8	14.1	13.6
	25+25+35+50	2.22	2.22	3.11	4.44	-	-	3.6	12.0	13.3	950	3250	3920	14.8	14.1	13.6
	25+25+35+60	2.07	2.07	2.90	4.97	-	-	3.6	12.0	13.3	950	3240	3920	14.7	14.1	13.5
	25+25+35+71	1.92	1.92	2.69	5.46	-	-	3.6	12.0	13.3	950	3240	3920	14.7	14.1	13.5
	25+25+50+50	2.00	2.00	4.00	4.00	-	-	3.6	12.0	13.3	950	3240	3920	14.7	14.1	13.5
	25+25+50+60	1.88	1.88	3.75	4.50	-	-	3.6	12.0	13.3	950	3240	3920	14.7	14.1	13.5
	25+35+35+35	2.31	3.23	3.23	3.23	-	-	3.6	12.0	13.3	950	3250	3920	14.8	14.1	13.6
	25+35+35+50	2.07	2.90	2.90	4.14	-	-	3.6	12.0	13.3	950	3240	3920	14.7	14.1	13.5
	25+35+35+60	1.94	2.71	2.71	4.65	-	-	3.6	12.0	13.3	950	3240	3920	14.7	14.1	13.5
	25+35+50+50	1.88	2.63	3.75	3.75	-	-	3.6	12.0	13.3	950	3240	3920	14.7	14.1	13.5
35+35+35+35	3.00	3.00	3.00	3.00	-	-	3.6	12.0	13.3	950	3240	3920	14.7	14.1	13.5	
35+35+35+50	2.71	2.71	2.71	3.87	-	-	3.6	12.0	13.3	950	3240	3920	14.7	14.1	13.5	
5 room	20+20+20+20+20	2.40	2.40	2.40	2.40	2.40	-	4.0	12.0	13.3	1050	3220	3620	14.7	14.0	13.4
	20+20+20+20+25	2.29	2.29	2.29	2.29	2.86	-	4.0	12.0	13.3	1050	3220	3620	14.7	14.0	13.4
	20+20+20+20+35	2.09	2.09	2.09	2.09	3.65	-	4.0	12.0	13.3	1050	3210	3620	14.6	14.0	13.4
	20+20+20+20+50	1.85	1.85	1.85	1.85	4.62	-	4.0	12.0	13.3	1050	3200	3620	14.6	13.9	13.3
	20+20+20+20+60	1.71	1.71	1.71	1.71	5.14	-	4.0	12.0	13.3	1050	3200	3620	14.6	13.9	13.3
	20+20+20+20+71	1.59	1.59	1.59	1.59	5.64	-	4.0	12.0	13.3	1050	3190	3620	14.5	13.9	13.3
	20+20+20+25+25	2.18	2.18	2.18	2.73	2.73	-	4.0	12.0	13.3	1050	3210	3620	14.6	14.0	13.4
	20+20+20+25+35	2.00	2.00	2.00	2.50	3.50	-	4.0	12.0	13.3	1050	3210	3620	14.6	14.0	13.4
	20+20+20+25+50	1.78	1.78	1.78	2.22	4.44	-	4.0	12.0	13.3	1050	3200	3620	14.6	13.9	13.3
	20+20+20+25+60	1.66	1.66	1.66	2.07	4.97	-	4.0	12.0	13.3	1050	3200	3620	14.6	13.9	13.3
	20+20+20+25+71	1.54	1.54	1.54	1.92	5.46	-	4.0	12.0	13.3	1050	3190	3620	14.5	13.9	13.3
	20+20+20+35+35	1.85	1.85	1.85	3.23	3.23	-	4.0	12.0	13.3	1050	3200	3620	14.6	13.9	13.3
20+20+20+35+50	1.66	1.66	1.66	2.90	4.14	-	4.0	12.0	13.3	1050	3200	3620	14.6	13.9	13.3	
20+20+20+35+60	1.55	1.55	1.55	2.71	4.65	-	4.0	12.0	13.3	1050	3190	3620	14.5	13.9	13.3	



MULTI-SPLIT SYSTEM

Indoor unit combination		Heating capacity (kW)									Power consumption(W)			Standard current(A)			
		Room heating capacity						Total capacity			Min.	Standard	Max.	220V	230V	240V	
		A	B	C	D	E	F	Min.	Standard	Max.							
Heating operation	5 room	20+20+20+50+50	1.50	1.50	1.50	3.75	3.75	-	4.0	12.0	13.3	1050	3190	3620	14.5	13.9	13.3
		20+20+25+25+25	2.09	2.09	2.61	2.61	2.61	-	4.0	12.0	13.3	1050	3210	3620	14.6	14.0	13.4
		20+20+25+25+35	1.92	1.92	2.40	2.40	3.36	-	4.0	12.0	13.3	1050	3210	3620	14.6	14.0	13.4
		20+20+25+25+50	1.71	1.71	2.14	2.14	4.29	-	4.0	12.0	13.3	1050	3200	3620	14.6	13.9	13.3
		20+20+25+25+60	1.60	1.60	2.00	2.00	4.80	-	4.0	12.0	13.3	1050	3190	3620	14.5	13.9	13.3
		20+20+25+35+35	1.78	1.78	2.22	3.11	3.11	-	4.0	12.0	13.3	1050	3200	3620	14.6	13.9	13.3
		20+20+25+35+50	1.60	1.60	2.00	2.80	4.00	-	4.0	12.0	13.3	1050	3190	3620	14.5	13.9	13.3
		20+20+25+35+60	1.50	1.50	1.88	2.63	4.50	-	4.0	12.0	13.3	1050	3190	3620	14.5	13.9	13.3
		20+20+35+35+35	1.66	1.66	2.90	2.90	2.90	-	4.0	12.0	13.3	1050	3200	3620	14.6	13.9	13.3
		20+20+35+35+50	1.50	1.50	2.63	2.63	3.75	-	4.0	12.0	13.3	1050	3190	3620	14.5	13.9	13.3
		20+25+25+25+25	2.00	2.50	2.50	2.50	2.50	-	4.0	12.0	13.3	1050	3210	3620	14.6	14.0	13.4
		20+25+25+25+35	1.85	2.31	2.31	2.31	3.23	-	4.0	12.0	13.3	1050	3200	3620	14.6	13.9	13.3
		20+25+25+25+50	1.66	2.07	2.07	2.07	4.14	-	4.0	12.0	13.3	1050	3200	3620	14.6	13.9	13.3
		20+25+25+25+60	1.55	1.94	1.94	1.94	4.65	-	4.0	12.0	13.3	1050	3190	3620	14.5	13.9	13.3
		20+25+25+35+35	1.71	2.14	2.14	3.00	3.00	-	4.0	12.0	13.3	1050	3200	3620	14.6	13.9	13.3
		20+25+25+35+50	1.55	1.94	1.94	2.71	3.87	-	4.0	12.0	13.3	1050	3190	3620	14.5	13.9	13.3
		20+25+25+35+60	1.60	2.00	2.80	2.80	2.80	-	4.0	12.0	13.3	1050	3190	3620	14.5	13.9	13.3
		20+35+35+35+35	1.50	2.63	2.63	2.63	2.63	-	4.0	12.0	13.3	1050	3190	3620	14.5	13.9	13.3
		25+25+25+25+25	2.40	2.40	2.40	2.40	2.40	-	4.0	12.0	13.3	1050	3210	3620	14.6	14.0	13.4
		25+25+25+25+35	2.22	2.22	2.22	2.22	3.11	-	4.0	12.0	13.3	1050	3200	3620	14.6	13.9	13.3
25+25+25+25+50	2.00	2.00	2.00	2.00	4.00	-	4.0	12.0	13.3	1050	3190	3620	14.5	13.9	13.3		
25+25+25+25+60	1.88	1.88	1.88	1.88	4.50	-	4.0	12.0	13.3	1050	3190	3620	14.5	13.9	13.3		
25+25+25+35+35	2.07	2.07	2.07	2.90	2.90	-	4.0	12.0	13.3	1050	3200	3620	14.6	13.9	13.3		
25+25+25+35+50	1.88	1.88	1.88	2.63	3.75	-	4.0	12.0	13.3	1050	3190	3620	14.5	13.9	13.3		
25+25+25+35+60	1.94	1.94	2.71	2.71	2.71	-	4.0	12.0	13.3	1050	3190	3620	14.5	13.9	13.3		

Indoor unit combination		Cooling capacity (kW)									Power consumption(W)			Standard current(A)			
		Room cooling capacity						Total capacity			Min.	Standard	Max.	220V	230V	240V	
		A	B	C	D	E	F	Min.	Standard	Max.							
Cooling operation	1 room	20	2.0	-	-	-	-	-	1.8	2.0	2.7	650	780	1100	3.6	3.4	3.3
		25	2.5	-	-	-	-	-	1.8	2.5	3.2	650	1000	1350	4.6	4.4	4.2
		35	3.5	-	-	-	-	-	1.8	3.5	3.7	650	1500	1600	6.9	6.6	6.3
		50	5.0	-	-	-	-	-	1.8	5.0	5.8	650	2150	2500	9.9	9.4	9.0
		60	6.0	-	-	-	-	-	1.8	6.0	6.7	650	2720	3000	12.5	11.9	11.4
	2 room	20+20	2.00	2.00	-	-	-	-	3.0	4.0	5.4	740	960	1460	4.4	4.2	4.0
		20+25	2.00	2.50	-	-	-	-	3.0	4.5	5.9	740	1100	1820	5.1	4.8	4.6
		20+35	2.00	3.50	-	-	-	-	3.0	5.5	6.4	740	1500	2020	6.9	6.6	6.3
		20+50	2.00	5.00	-	-	-	-	3.0	7.0	8.5	740	2290	2820	10.5	10.1	9.6
		20+60	2.00	6.00	-	-	-	-	3.0	8.0	9.4	740	2660	3360	12.2	11.7	11.2
		20+71	2.00	7.10	-	-	-	-	3.0	9.1	9.9	740	3100	3780	14.1	13.5	12.9
		25+25	2.50	2.50	-	-	-	-	3.0	5.0	6.8	740	1420	2200	6.5	6.2	6.0
		25+35	2.50	3.50	-	-	-	-	3.0	6.0	6.9	740	1810	2320	8.3	7.9	7.6
		25+50	2.50	5.00	-	-	-	-	3.0	7.5	9.0	740	2470	3220	11.3	10.8	10.4
		25+60	2.50	6.00	-	-	-	-	3.0	8.5	9.4	740	2810	3360	12.9	12.3	11.8
		25+71	2.53	7.17	-	-	-	-	3.0	9.7	10.4	740	3350	4020	15.4	14.7	14.1
		35+35	3.50	3.50	-	-	-	-	3.0	7.0	7.4	740	2290	2820	10.5	10.1	9.6
		35+50	3.50	5.00	-	-	-	-	3.0	8.5	9.5	740	2810	3620	12.9	12.3	11.8
		35+60	3.50	6.00	-	-	-	-	3.0	9.5	10.4	740	3280	3990	15.1	14.4	13.8
		35+71	3.30	6.70	-	-	-	-	3.0	10.0	10.9	740	3480	4250	15.8	15.1	14.5
50+50		5.00	5.00	-	-	-	-	3.0	10.0	11.6	740	3480	4350	16.0	15.3	14.6	
50+60		4.55	5.45	-	-	-	-	3.0	10.0	11.8	740	3480	4410	16.0	15.3	14.6	
50+71		4.13	5.87	-	-	-	-	3.0	10.0	11.8	740	3470	4410	15.8	15.1	14.5	
60+60		5.00	5.00	-	-	-	-	3.0	10.0	11.8	740	3470	4410	15.9	15.2	14.6	
60+71		4.58	5.42	-	-	-	-	3.0	10.0	11.8	740	3470	4410	15.8	15.1	14.5	
71+71	5.00	5.00	-	-	-	-	3.0	10.0	11.8	740	3460	4410	15.6	14.9	14.3		
3 room	20+20+20	2.00	2.00	2.00	-	-	-	3.7	6.0	8.1	880	1530	2490	7.0	6.7	6.4	
	20+20+25	2.00	2.00	2.50	-	-	-	3.7	6.5	8.6	880	1730	2700	7.9	7.6	7.3	
	20+20+35	2.00	2.00	3.50	-	-	-	3.7	7.5	9.1	880	2080	3120	9.6	9.1	8.8	
	20+20+50	2.00	2.00	5.00	-	-	-	3.7	9.0	11.2	880	2730	4000	12.5	12.0	11.5	
	20+20+60	2.00	2.00	6.00	-	-	-	3.7	10.0	11.8	880	3280	4250	15.1	14.4	13.8	
	20+20+71	1.80	1.80	6.40	-	-	-	3.7	10.0	11.8	880	3280	4250	15.1	14.4	13.8	
	20+25+25	2.00	2.50	2.50	-	-	-	3.7	7.0	9.1	880	1940	3210	8.9	8.5	8.2	
	20+25+35	2.00	2.50	3.50	-	-	-	3.7	8.0	9.6	880	2440	3630	11.2	10.7	10.3	
	20+25+50	2.00	2.50	5.00	-	-	-	3.7	9.5	11.5	880	3130	4120	14.4	13.7	13.2	
	20+25+60	1.90	2.38	5.71	-	-	-	3.7	10.0	11.8	880	3280	4250	15.1	14.4	13.8	
	20+25+71	1.72	2.16	6.12	-	-	-	3.7	10.0	11.8	880	3280	4250	15.1	14.4	13.8	
	20+35+35	2.00	3.50	3.50	-	-	-	3.7	9.0	10.1	880	2920	3640	13.4	12.8	12.3	
	20+35+50	1.90	3.33	4.76	-	-	-	3.7	10.0	11.8	880	3280	4250	15.1	14.4	13.8	
	20+35+60	1.74	3.04	5.22	-	-	-	3.7	10.0	11.8	880	3280	4250	15.1	14.4	13.8	
	20+35+71	1.59	2.78	5.63	-	-	-	4.7	10.0	11.8	880	3270	4250	15.0	14.4	13.8	
	20+50+50	1.67	4.17	4.17	-	-	-	3.7	10.0	11.8	880	3270	4250	15.0	14.4	13.8	
	20+50+60	1.54	3.85	4.62	-	-	-	3.7	10.0	11.8	880	3270	4250	15.0	14.4	13.8	
	20+50+71	1.42	3.55	5.04	-	-	-	3.7	10.0	11.8	880	3260	4250	15.0	14.3	13.7	
	20+60+60	1.43	4.29	4.29	-	-	-	3.7	10.0	11.8	880	3260	4250	15.0	14.3	13.7	
	20+60+71	1.32	3.97	4.70	-	-	-	3.7	10.0	11.8	880	3260	4250	15.0	14.3	13.7	
25+25+25	2.50	2.50	2.50	-	-	-	3.7	7.5	9.4	880	2130	3340	9.8	9.4	9.0		

COMBINATIONS

Indoor unit combination		Cooling capacity (kW)									Power consumption(W)			Standard current(A)		
		Room cooling capacity						Total capacity			Min.	Standard	Max.	220V	230V	240V
		A	B	C	D	E	F	Min.	Standard	Max.						
3 room	25+25+35	2.50	2.50	3.50	-	-	-	3.7	8.5	9.9	880	2650	3540	12.2	11.6	11.2
	25+25+50	2.50	2.50	5.00	-	-	-	3.7	10.0	11.8	880	3280	4250	15.1	14.4	13.8
	25+25+60	2.27	2.27	5.45	-	-	-	3.7	10.0	11.8	880	3280	4250	15.1	14.4	13.8
	25+25+71	2.07	2.07	5.87	-	-	-	3.7	10.0	11.8	880	3270	4250	15.0	14.4	13.8
	25+35+35	2.50	3.50	3.50	-	-	-	3.7	9.5	10.4	880	3130	3950	14.4	13.7	13.2
	25+35+50	2.27	3.18	4.55	-	-	-	3.7	10.0	11.8	880	3280	4250	15.1	14.4	13.8
	25+35+60	2.08	2.92	5.00	-	-	-	3.7	10.0	11.8	880	3270	4250	15.0	14.4	13.8
	25+35+71	1.91	2.67	5.42	-	-	-	3.7	10.0	11.8	880	3270	4250	15.0	14.4	13.8
	25+50+50	2.00	4.00	4.00	-	-	-	3.7	10.0	11.8	880	3270	4250	15.0	14.4	13.8
	25+50+60	1.85	3.70	4.44	-	-	-	3.7	10.0	11.8	880	3270	4250	15.0	14.4	13.8
	25+50+71	1.71	3.42	4.86	-	-	-	3.7	10.0	11.8	880	3260	4250	21.4	20.5	19.7
	25+60+60	1.72	4.14	4.14	-	-	-	3.7	10.0	11.8	880	3260	4250	21.4	20.5	19.7
	35+60+71	1.60	3.85	4.55	-	-	-	3.7	10.0	11.8	880	3260	4250	21.4	20.5	19.7
	35+35+35	3.33	3.33	3.33	-	-	-	3.7	10.0	10.9	880	3280	4120	15.1	14.4	13.8
	35+35+50	2.92	2.92	4.17	-	-	-	3.7	10.0	11.8	880	3270	4250	15.0	14.4	13.8
	35+35+60	2.69	2.69	4.62	-	-	-	3.7	10.0	11.8	880	3270	4250	15.0	14.4	13.8
	35+35+71	2.48	2.48	5.04	-	-	-	3.7	10.0	11.8	880	3260	4250	14.8	14.2	13.6
	35+50+50	2.59	3.70	3.70	-	-	-	3.7	10.0	11.8	880	3270	4250	15.0	14.4	13.8
	35+50+60	2.41	3.45	4.14	-	-	-	3.7	10.0	11.8	880	3260	4250	15.0	14.3	13.7
	35+50+71	2.24	3.21	4.55	-	-	-	3.7	10.0	11.8	880	3260	4250	15.0	14.3	13.7
35+60+60	2.26	3.87	3.87	-	-	-	3.7	10.0	11.8	880	3260	4250	15.0	14.3	13.7	
50+50+50	3.33	3.33	3.33	-	-	-	3.7	10.0	11.8	880	3260	4250	15.0	14.3	13.7	
50+50+60	3.13	3.13	3.75	-	-	-	3.7	10.0	11.8	880	3260	4250	15.0	14.3	13.7	
Cooling operation	20+20+20+20	2.00	2.00	2.00	2.00	-	-	4.4	8.0	10.8	1100	2110	3680	9.6	9.2	8.8
	20+20+20+25	2.00	2.00	2.00	2.50	-	-	4.4	8.5	11.1	1100	2390	3890	10.9	10.4	10.0
	20+20+20+35	2.00	2.00	2.00	3.50	-	-	4.4	9.5	11.6	1100	2900	3990	13.2	12.6	12.1
	20+20+20+50	1.82	1.82	1.82	4.55	-	-	4.4	10.0	11.8	1100	3210	4050	14.6	14.0	13.4
	20+20+20+60	1.67	1.67	1.67	5.00	-	-	4.4	10.0	11.8	1100	3210	4050	14.6	14.0	13.4
	20+20+20+71	1.53	1.53	1.53	5.42	-	-	4.4	10.0	11.8	1100	3200	4050	14.4	13.8	13.2
	20+20+25+25	2.00	2.00	2.50	2.50	-	-	4.4	9.0	11.6	1100	2600	3990	11.8	11.3	10.8
	20+20+25+35	2.00	2.00	2.50	3.50	-	-	4.4	10.0	11.8	1100	3220	4050	14.7	14.0	13.4
	20+20+25+50	1.74	1.74	2.17	4.35	-	-	4.4	10.0	11.8	1100	3210	4050	14.6	14.0	13.4
	20+20+25+60	1.60	1.60	2.00	4.80	-	-	4.4	10.0	11.8	1100	3210	4050	14.6	14.0	13.4
	20+20+25+71	1.47	1.47	1.84	5.22	-	-	4.4	10.0	11.8	1100	3200	4050	14.6	13.9	13.3
	20+20+35+35	1.82	1.82	3.18	3.18	-	-	4.4	10.0	11.8	1100	3210	4050	14.6	14.0	13.4
	20+20+35+50	1.60	1.60	2.80	4.00	-	-	4.4	10.0	11.8	1100	3210	4050	14.6	14.0	13.4
	20+20+35+60	1.48	1.48	2.59	4.44	-	-	4.4	10.0	11.8	1100	3200	4050	14.6	13.9	13.3
	20+20+35+71	1.37	1.37	2.40	4.86	-	-	4.4	10.0	11.8	1100	3190	4050	14.5	13.9	13.3
	20+20+50+50	1.43	1.43	3.57	3.57	-	-	4.4	10.0	11.8	1100	3190	4050	14.5	13.9	13.3
	20+20+50+60	1.33	1.33	3.33	4.00	-	-	4.4	10.0	11.8	1100	3190	4050	14.5	13.9	13.3
	20+20+60+60	1.25	1.25	3.75	3.75	-	-	4.4	10.0	11.8	1100	3180	4050	14.5	13.8	13.3
	20+25+25+25	2.00	2.50	2.50	2.50	-	-	4.4	9.5	11.8	1100	2900	4050	13.2	12.6	12.1
	20+25+25+35	1.90	2.38	2.38	3.33	-	-	4.4	10.0	11.8	1100	3220	4050	14.7	14.0	13.4
	20+25+25+50	1.67	2.08	2.08	4.17	-	-	4.4	10.0	11.8	1100	3210	4050	14.6	14.0	13.4
	20+25+25+60	1.54	1.92	1.92	4.62	-	-	4.4	10.0	11.8	1100	3200	4050	14.6	13.9	13.3
	21+26+26+71	1.46	1.81	1.81	4.93	-	-	4.4	10.0	11.8	1100	3190	4050	14.5	13.9	13.3
	20+25+35+35	1.74	2.17	3.04	3.04	-	-	4.4	10.0	11.8	1100	3210	4050	14.6	14.0	13.4
	20+25+35+50	1.54	1.92	2.69	3.85	-	-	4.4	10.0	11.8	1100	3200	4050	14.6	13.9	13.3
	20+25+35+60	1.43	1.79	2.50	4.29	-	-	4.4	10.0	11.8	1100	3190	4050	14.5	13.9	13.3
	20+25+35+71	1.32	1.66	2.32	4.70	-	-	4.4	10.0	11.8	1100	3190	4050	14.5	13.9	13.3
	20+25+50+50	1.38	1.72	3.45	3.45	-	-	4.4	10.0	11.8	1100	3190	4050	14.5	13.9	13.3
	20+25+50+60	1.29	1.61	3.23	3.87	-	-	4.4	10.0	11.8	1100	3190	4050	14.5	13.9	13.3
	20+35+35+35	1.60	2.80	2.80	2.80	-	-	4.4	10.0	11.8	1100	3210	4050	14.6	14.0	13.4
	20+35+35+50	1.43	2.50	2.50	3.57	-	-	4.4	10.0	11.8	1100	3190	4050	14.5	13.9	13.3
	20+35+35+60	1.33	2.33	2.33	4.00	-	-	4.4	10.0	11.8	1100	3190	4050	14.5	13.9	13.3
	20+35+50+50	1.29	2.26	3.23	3.23	-	-	4.4	10.0	11.8	1100	3190	4050	14.5	13.9	13.3
	25+25+25+25	2.50	2.50	2.50	2.50	-	-	4.4	10.0	11.8	1100	3220	4050	14.7	14.0	13.4
	25+25+25+35	2.27	2.27	2.27	3.18	-	-	4.4	10.0	11.8	1100	3210	4050	14.6	14.0	13.4
	25+25+25+50	2.00	2.00	2.00	4.00	-	-	4.4	10.0	11.8	1100	3210	4050	14.6	14.0	13.4
	25+25+25+60	1.85	1.85	1.85	4.44	-	-	4.4	10.0	11.8	1100	3200	4050	14.6	13.9	13.3
	25+25+25+71	1.71	1.71	1.71	4.86	-	-	4.4	10.0	11.8	1100	3190	4050	14.5	13.9	13.3
	25+25+35+35	2.08	2.08	2.92	2.92	-	-	4.4	10.0	11.8	1100	3210	4050	14.6	14.0	13.4
	25+25+35+50	1.85	1.85	2.59	3.70	-	-	4.4	10.0	11.8	1100	3200	4050	14.6	13.9	13.3
25+25+35+60	1.72	1.72	2.41	4.14	-	-	4.4	10.0	11.8	1100	3190	4050	14.5	13.9	13.3	
25+25+35+71	1.60	1.60	2.24	4.55	-	-	4.4	10.0	11.8	1100	3190	4050	14.5	13.9	13.3	
25+25+50+50	1.67	1.67	3.33	3.33	-	-	4.4	10.0	11.8	1100	3190	4050	14.5	13.9	13.3	
25+25+50+60	1.56	1.56	3.13	3.75	-	-	4.4	10.0	11.8	1100	3180	4050	14.5	13.8	13.3	
25+35+35+35	1.92	2.69	2.69	2.69	-	-	4.4	10.0	11.8	1100	3200	4050	14.6	13.9	13.3	
25+35+35+50	1.72	2.41	2.41	3.45	-	-	4.4	10.0	11.8	1100	3190	4050	14.5	13.9	13.3	
25+35+35+60	1.61	2.26	2.26	3.87	-	-	4.4	10.0	11.8	1100	3190	4050	14.5	13.9	13.3	
25+35+50+50	1.56	2.19	3.13	3.13	-	-	4.4	10.0	11.8	1100	3180	4050	14.5	13.8	13.3	
35+35+35+35	2.50	2.50	2.50	2.50	-	-	4.4	10.0	11.8	1100	3190	4050	14.5	13.9	13.3	
35+35+35+50	2.26	2.26	2.26	3.23	-	-	4.4	10.0	11.8	1100	3190	4050	14.5	13.9	13.3	
5 room	20+20+20+20+20	2.00	2.00	2.00	2.00	2.00	-	5.1	10.0	11.8	1210	2950	4030	13.4	12.8	12.3
	20+															



MULTI-SPLIT SYSTEM

Indoor unit combination		Cooling capacity (kW)									Power consumption(W)			Standard current(A)			
		Room cooling capacity						Total capacity			Min.	Standard	Max.	220V	230V	240V	
		A	B	C	D	E	F	Min.	Standard	Max.							
Cooling operation	5 room	20+20+20+20+60	1.43	1.43	1.43	1.43	4.29	-	5.1	10.0	11.8	1210	2930	4030	13.3	12.8	12.2
		20+20+20+20+71	1.32	1.32	1.32	1.32	4.70	-	5.1	10.0	11.8	1210	2930	4030	13.3	12.8	12.2
		20+20+20+25+25	1.82	1.82	1.82	2.27	2.27	-	5.1	10.0	11.8	1210	2950	4030	13.4	12.8	12.3
		20+20+20+25+35	1.67	1.67	1.67	2.08	2.92	-	5.1	10.0	11.8	1210	2940	4030	13.4	12.8	12.3
		20+20+20+25+50	1.48	1.48	1.48	1.85	3.70	-	5.1	10.0	11.8	1210	2940	4030	13.4	12.8	12.3
		20+20+20+25+60	1.38	1.38	1.38	1.72	4.14	-	5.1	10.0	11.8	1210	2930	4030	13.3	12.8	12.2
		20+20+20+25+71	1.28	1.28	1.28	1.60	4.55	-	5.1	10.0	11.8	1210	2930	4030	13.3	12.8	12.2
		20+20+20+35+35	1.54	1.54	1.54	2.69	2.69	-	5.1	10.0	11.8	1210	2940	4030	13.4	12.8	12.3
		20+20+20+35+50	1.38	1.38	1.38	2.41	3.45	-	5.1	10.0	11.8	1210	2930	4030	13.3	12.8	12.2
		20+20+20+35+60	1.29	1.29	1.29	2.26	3.87	-	5.1	10.0	11.8	1210	2930	4030	13.3	12.8	12.2
		20+20+20+50+50	1.25	1.25	1.25	3.13	3.13	-	5.1	10.0	11.8	1210	2930	4030	13.3	12.8	12.2
		20+20+25+25+25	1.74	1.74	2.17	2.17	2.17	-	5.1	10.0	11.8	1210	2950	4030	13.4	12.8	12.3
		20+20+25+25+35	1.60	1.60	2.00	2.00	2.80	-	5.1	10.0	11.8	1210	2940	4030	13.4	12.8	12.3
		20+20+25+25+50	1.43	1.43	1.79	1.79	3.57	-	5.1	10.0	11.8	1210	2930	4030	13.3	12.8	12.2
		20+20+25+25+60	1.33	1.33	1.67	1.67	4.00	-	5.1	10.0	11.8	1210	2930	4030	13.3	12.8	12.2
		20+20+25+35+35	1.48	1.48	1.85	2.59	2.59	-	5.1	10.0	11.8	1210	2940	4030	13.4	12.8	12.3
		20+20+25+35+50	1.33	1.33	1.67	2.33	3.33	-	5.1	10.0	11.8	1210	2930	4030	13.3	12.8	12.2
		20+20+25+35+60	1.25	1.25	1.56	2.19	3.75	-	5.1	10.0	11.8	1210	2930	4030	13.3	12.8	12.2
		20+20+35+35+35	1.38	1.38	2.41	2.41	2.41	-	5.1	10.0	11.8	1210	2930	4030	13.3	12.8	12.2
		20+20+35+35+50	1.25	1.25	2.19	2.19	3.13	-	5.1	10.0	11.8	1210	2930	4030	13.3	12.8	12.2
		20+25+25+25+25	1.67	2.08	2.08	2.08	2.08	-	5.1	10.0	11.8	1210	2940	4030	13.4	12.8	12.3
		20+25+25+25+35	1.54	1.92	1.92	1.92	2.69	-	5.1	10.0	11.8	1210	2940	4030	13.4	12.8	12.3
		20+25+25+25+50	1.38	1.72	1.72	1.72	3.45	-	5.1	10.0	11.8	1210	2930	4030	13.3	12.8	12.2
		20+25+25+25+60	1.29	1.61	1.61	1.61	3.87	-	5.1	10.0	11.8	1210	2930	4030	13.3	12.8	12.2
		20+25+25+35+35	1.43	1.79	1.79	2.50	2.50	-	5.1	10.0	11.8	1210	2930	4030	13.3	12.8	12.2
		20+25+25+35+50	1.29	1.61	1.61	2.26	3.23	-	5.1	10.0	11.8	1210	2930	4030	13.3	12.8	12.2
		20+25+35+35+35	1.33	1.67	2.33	2.33	2.33	-	5.1	10.0	11.8	1210	2930	4030	13.3	12.8	12.2
		20+35+35+35+35	1.25	2.19	2.19	2.19	2.19	-	5.1	10.0	11.8	1210	2930	4030	13.3	12.8	12.2
25+25+25+25+25	2.00	2.00	2.00	2.00	2.00	-	5.1	10.0	11.8	1210	2940	4030	13.4	12.8	12.3		
25+25+25+25+35	1.85	1.85	1.85	1.85	2.59	-	5.1	10.0	11.8	1210	2940	4030	13.4	12.8	12.3		
25+25+25+25+50	1.67	1.67	1.67	1.67	3.33	-	5.1	10.0	11.8	1210	2930	4030	13.3	12.8	12.2		
25+25+25+25+60	1.56	1.56	1.56	1.56	3.75	-	5.1	10.0	11.8	1210	2930	4030	13.3	12.8	12.2		
25+25+25+35+35	1.72	1.72	1.72	2.41	2.41	-	5.1	10.0	11.8	1210	2930	4030	13.3	12.8	12.2		
25+25+25+35+50	1.56	1.56	1.56	2.19	3.13	-	5.1	10.0	11.8	1210	2930	4030	13.3	12.8	12.2		
25+25+35+35+35	1.61	1.61	2.26	2.26	2.26	-	5.1	10.0	11.8	1210	2930	4030	13.3	12.8	12.2		

SCM125ZM-S Table of Indoor unit combination only with SRK-ZSX type

Indoor unit combination		Heating capacity (kW)									Power consumption(W)			Standard current(A)			
		Room heating capacity						Total capacity			Min.	Standard	Max.	220V	230V	240V	
		A	B	C	D	E	F	Min.	Standard	Max.							
Heating operation	1 room	20	3.0	-	-	-	-	1.5	3.0	3.7	700	1010	1330	4.6	4.4	4.3	
		25	3.4	-	-	-	-	1.5	3.4	4.2	700	1150	1540	5.3	5.1	4.8	
		35	4.5	-	-	-	-	1.5	4.5	5.0	700	1540	1840	7.1	6.8	6.5	
		50	5.8	-	-	-	-	1.5	5.8	6.5	700	2000	2410	9.2	8.8	8.4	
		60	6.8	-	-	-	-	1.5	6.8	7.5	700	2360	2760	10.8	10.4	9.9	
	2 room	20+20	3.00	3.00	-	-	-	-	2.1	6.0	7.4	750	1510	1460	6.9	6.6	6.4
		20+25	2.84	3.56	-	-	-	-	2.1	6.4	7.9	750	1630	2210	7.5	7.2	6.9
		20+35	2.73	4.77	-	-	-	-	2.1	7.5	8.7	750	1950	2520	9.0	8.6	8.2
		20+50	2.51	6.29	-	-	-	-	2.1	8.8	10.2	750	2380	3220	10.9	10.5	10.0
		20+60	2.45	7.35	-	-	-	-	2.1	9.8	11.2	750	2780	3620	12.8	12.2	11.7
		25+25	3.40	3.40	-	-	-	-	2.1	6.8	8.4	750	1740	2420	8.0	7.6	7.3
		25+35	3.29	4.61	-	-	-	-	2.1	7.9	9.2	750	2100	2820	9.6	9.2	8.8
		25+50	3.07	6.13	-	-	-	-	2.1	9.2	10.7	750	2580	3610	11.8	11.3	10.9
		25+60	3.00	7.20	-	-	-	-	2.1	10.2	11.7	750	2980	3790	13.7	13.1	12.5
		35+35	4.50	4.50	-	-	-	-	2.1	9.0	10.0	750	2470	3210	11.3	10.8	10.4
		35+50	4.24	6.06	-	-	-	-	2.1	10.3	11.5	750	2980	3710	13.7	13.1	12.5
		35+60	4.16	7.14	-	-	-	-	2.1	11.3	12.5	750	3350	4320	15.4	14.7	14.1
		50+50	5.80	5.80	-	-	-	-	2.1	11.6	13.0	750	3590	4620	16.5	15.8	15.1
	50+60	5.73	6.87	-	-	-	-	2.1	12.6	14.0	750	4010	5230	18.4	17.6	16.9	
	60+60	6.75	6.75	-	-	-	-	2.1	13.5	14.0	750	4450	5230	20.4	19.5	18.7	
	3 room	20+20+20	3.00	3.00	3.00	-	-	-	3.2	9.0	11.1	780	2230	3350	10.2	9.8	9.4
		20+20+25	2.89	2.89	3.62	-	-	-	3.2	9.4	11.6	780	2350	3550	10.8	10.3	9.9
		20+20+35	2.80	2.80	4.90	-	-	-	3.2	10.5	12.4	780	2710	3820	12.4	11.9	11.4
		20+20+50	2.62	2.62	6.56	-	-	-	3.2	11.8	13.9	780	3210	4290	14.7	14.1	13.5
		20+20+60	2.56	2.56	7.68	-	-	-	3.2	12.8	14.0	780	3620	4350	16.6	15.9	15.2
		20+25+25	2.80	3.50	3.50	-	-	-	3.2	9.8	12.1	780	2510	3720	11.5	11.0	10.6
		20+25+35	2.73	3.41	4.77	-	-	-	3.2	10.9	12.9	780	2910	3990	13.4	12.8	12.2
		20+25+50	2.57	3.21	6.42	-	-	-	3.2	12.2	14.0	780	3410	4350	15.7	15.0	14.4
20+25+60		2.51	3.14	7.54	-	-	-	3.2	13.2	14.0	780	3910	4350	18.0	17.2	16.5	
20+35+35		2.67	4.67	4.67	-	-	-	3.2	12.0	13.7	780	3390	4220	15.6	14.9	14.3	
20+35+50		2.53	4.43	6.33	-	-	-	3.2	13.3	14.0	780	3900	4350	17.9	17.1	16.4	
20+35+60		2.35	4.11	7.04	-	-	-	3.2	13.5	14.0	780	4050	4350	18.6	17.8	17.0	
20+50+50		2.25	5.63	5.63	-	-	-	3.2	13.5	14.0	780	4050	4350	18.6	17.8	17.0	
20+50+60	2.08	5.19	6.23	-	-	-	3.2	13.5	14.0	780	4050	4350	18.6	17.8	17.0		
20+60+60	1.93	5.79	5.79	-	-	-	3.2	13.5	14.0	780	4050	4350	18.6	17.8	17.0		

COMBINATIONS

Indoor unit combination		Heating capacity (kW)									Power consumption(W)			Standard current(A)		
		Room heating capacity						Total capacity			Min.	Standard	Max.	220V	230V	240V
		A	B	C	D	E	F	Min.	Standard	Max.						
3 room	25+25+25	3.40	3.40	3.40	-	-	-	3.2	10.2	12.6	780	2710	3880	12.4	11.9	11.4
	25+25+35	3.32	3.32	4.65	-	-	-	3.2	11.3	13.4	780	3110	4120	14.3	13.7	13.1
	25+25+50	3.15	3.15	6.30	-	-	-	3.2	12.6	14.0	780	3620	4350	16.6	15.9	15.2
	25+25+60	3.07	3.07	7.36	-	-	-	3.2	13.5	14.0	780	4050	4350	18.6	17.8	17.0
	25+35+35	3.26	4.57	4.57	-	-	-	3.2	12.4	14.0	780	3710	4350	17.0	16.3	15.6
	25+35+50	3.07	4.30	6.14	-	-	-	3.2	13.5	14.0	780	4060	4350	18.6	17.8	17.1
	25+35+60	2.81	3.94	6.75	-	-	-	3.2	13.5	14.0	780	4060	4350	18.6	17.8	17.1
	25+50+50	2.70	5.40	5.40	-	-	-	3.2	13.5	14.0	780	4050	4350	18.6	17.8	17.0
	25+50+60	2.50	5.00	6.00	-	-	-	3.2	13.5	14.0	780	4050	4350	18.6	17.8	17.0
	25+60+60	2.33	5.59	5.59	-	-	-	3.2	13.5	14.0	780	4050	4350	18.6	17.8	17.0
	35+35+35	4.50	4.50	4.50	-	-	-	3.2	13.5	14.0	780	4060	4350	18.6	17.8	17.1
	35+35+50	3.94	3.94	5.63	-	-	-	3.2	13.5	14.0	780	4060	4350	18.6	17.8	17.1
	35+35+60	3.63	3.63	6.23	-	-	-	3.2	13.5	14.0	780	4050	4350	18.6	17.8	17.0
	35+50+50	3.50	5.00	5.00	-	-	-	3.2	13.5	14.0	780	4050	4350	18.6	17.8	17.0
	35+50+60	3.26	4.66	5.59	-	-	-	3.2	13.5	14.0	780	4050	4350	18.6	17.8	17.0
	35+60+60	3.05	5.23	5.23	-	-	-	3.2	13.5	14.0	780	4050	4350	18.6	17.8	17.0
	50+50+50	4.50	4.50	4.50	-	-	-	3.2	13.5	14.0	780	4040	4350	18.5	17.7	17.0
	50+50+60	4.22	4.22	5.06	-	-	-	3.2	13.5	14.0	780	4040	4350	18.5	17.7	17.0
	50+60+60	3.97	4.76	4.76	-	-	-	3.2	13.5	14.0	780	4040	4350	18.5	17.7	17.0
	60+60+60	4.50	4.50	4.50	-	-	-	3.2	13.5	14.0	780	4030	4350	18.5	17.7	17.0
4 room	20+20+20+20	3.00	3.00	3.00	3.00	-	-	3.6	12.0	14.0	950	3210	3920	14.6	14.0	13.4
	20+20+20+25	2.92	2.92	2.92	3.65	-	-	3.6	12.4	14.0	950	3390	3920	15.4	14.8	14.1
	20+20+20+35	2.84	2.84	2.84	4.97	-	-	3.6	13.5	14.0	950	3700	3920	16.8	16.1	15.4
	20+20+20+50	2.45	2.45	2.45	6.14	-	-	3.6	13.5	14.0	950	3690	3920	16.8	16.1	15.4
	20+20+20+60	2.25	2.25	2.25	6.75	-	-	3.6	13.5	14.0	950	3690	3920	16.8	16.1	15.4
	20+20+25+25	2.84	2.84	3.56	3.56	-	-	3.6	12.8	14.0	950	3440	3920	15.7	15.0	14.3
	20+20+25+35	2.70	2.70	3.38	4.73	-	-	3.6	13.5	14.0	950	3700	3920	16.8	16.1	15.4
	20+20+25+50	2.35	2.35	2.93	5.87	-	-	3.6	13.5	14.0	950	3690	3920	16.8	16.1	15.4
	20+20+25+60	2.16	2.16	2.70	6.48	-	-	3.6	13.5	14.0	950	3680	3920	16.7	16.0	15.3
	20+20+35+35	2.45	2.45	4.30	4.30	-	-	3.6	13.5	14.0	950	3690	3920	16.8	16.1	15.4
	20+20+35+50	2.16	2.16	3.78	5.40	-	-	3.6	13.5	14.0	950	3680	3920	16.7	16.0	15.3
	20+20+35+60	2.00	2.00	3.50	6.00	-	-	3.6	13.5	14.0	950	3680	3920	16.7	16.0	15.3
	20+20+50+50	1.93	1.93	4.82	4.82	-	-	3.6	13.5	14.0	950	3670	3920	16.7	16.0	15.3
	20+20+50+60	1.80	1.80	4.50	5.40	-	-	3.6	13.5	14.0	950	3670	3920	16.7	16.0	15.3
	20+20+60+60	1.69	1.69	5.06	5.06	-	-	3.6	13.5	14.0	950	3670	3920	16.7	16.0	15.3
	20+25+25+25	2.78	3.47	3.47	3.47	-	-	3.6	13.2	14.0	950	3550	3920	16.2	15.5	14.8
	20+25+25+35	2.57	3.21	3.21	4.50	-	-	3.6	13.5	14.0	950	3700	3920	16.8	16.1	15.4
	20+25+25+50	2.25	2.81	2.81	5.63	-	-	3.6	13.5	14.0	950	3690	3920	16.8	16.1	15.4
	20+25+25+60	2.08	2.60	2.60	6.23	-	-	3.6	13.5	14.0	950	3680	3920	16.7	16.0	15.3
	20+25+35+35	2.35	2.93	4.11	4.11	-	-	3.6	13.5	14.0	950	3690	3920	16.8	16.1	15.4
	20+25+35+50	2.08	2.60	3.63	5.19	-	-	3.6	13.5	14.0	950	3680	3920	16.7	16.0	15.3
	20+25+35+60	1.93	2.41	3.38	5.79	-	-	3.6	13.5	14.0	950	3670	3920	16.7	16.0	15.3
	20+25+50+50	1.86	2.33	4.66	4.66	-	-	3.6	13.5	14.0	950	3670	3920	16.7	16.0	15.3
	20+25+50+60	1.74	2.18	4.35	5.23	-	-	3.6	13.5	14.0	950	3670	3920	16.7	16.0	15.3
	20+25+60+60	1.64	2.05	4.91	4.91	-	-	3.6	13.5	14.0	950	3660	3920	16.7	15.9	15.3
	20+35+35+35	2.16	3.78	3.78	3.78	-	-	3.6	13.5	14.0	950	3680	3920	16.7	16.0	15.3
	20+35+35+50	1.93	3.38	3.38	4.82	-	-	3.6	13.5	14.0	950	3670	3920	16.7	16.0	15.3
	20+35+35+60	1.80	3.15	3.15	5.40	-	-	3.6	13.5	14.0	950	3670	3920	16.7	16.0	15.3
	20+35+50+50	1.74	3.05	4.35	4.35	-	-	3.6	13.5	14.0	950	3670	3920	16.7	16.0	15.3
	20+35+50+60	1.64	2.86	4.09	4.91	-	-	3.6	13.5	14.0	950	3660	3920	16.7	15.9	15.3
	20+35+60+60	1.54	2.70	4.63	4.63	-	-	3.6	13.5	14.0	950	3660	3920	16.7	15.9	15.3
	20+50+50+50	1.59	3.97	3.97	3.97	-	-	3.6	13.5	14.0	950	3660	3920	16.7	15.9	15.3
	20+50+50+60	1.50	3.75	3.75	4.50	-	-	3.6	13.5	14.0	950	3660	3920	16.7	15.9	15.3
	20+50+60+60	1.42	3.55	4.26	4.26	-	-	3.6	13.5	14.0	950	3650	3920	16.6	15.9	15.2
	25+25+25+25	3.38	3.38	3.38	3.38	-	-	3.6	13.5	14.0	950	3700	3920	16.8	16.1	15.4
	25+25+25+35	3.07	3.07	3.07	4.30	-	-	3.6	13.5	14.0	950	3690	3920	16.8	16.1	15.4
	25+25+25+50	2.70	2.70	2.70	5.40	-	-	3.6	13.5	14.0	950	3680	3920	16.7	16.0	15.3
	25+25+25+60	2.50	2.50	2.50	6.00	-	-	3.6	13.5	14.0	950	3680	3920	16.7	16.0	15.3
	25+25+35+35	2.81	2.81	3.94	3.94	-	-	3.6	13.5	14.0	950	3690	3920	16.8	16.1	15.4
	25+25+35+50	2.50	2.50	3.50	5.00	-	-	3.6	13.5	14.0	950	3680	3920	16.7	16.0	15.3
25+25+35+60	2.33	2.33	3.26	5.59	-	-	3.6	13.5	14.0	950	3670	3920	16.7	16.0	15.3	
25+25+50+50	2.25	2.25	4.50	4.50	-	-	3.6	13.5	14.0	950	3670	3920	16.7	16.0	15.3	
25+25+50+60	2.11	2.11	4.22	5.06	-	-	3.6	13.5	14.0	950	3670	3920	16.7	16.0	15.3	
25+25+60+60	1.99	1.99	4.76	4.76	-	-	3.6	13.5	14.0	950	3660	3920	16.7	15.9	15.3	
25+35+35+35	2.60	3.63	3.63	3.63	-	-	3.6	13.5	14.0	950	3680	3920	16.7	16.0	15.3	
25+35+35+50	2.33	3.26	3.26	4.66	-	-	3.6	13.5	14.0	950	3670	3920	16.7	16.0	15.3	
25+35+35+60	2.18	3.05	3.05	5.23	-	-	3.6	13.5	14.0	950	3670	3920	16.7	16.0	15.3	
25+35+50+50	2.11	2.95	4.22	4.22	-	-	3.6	13.5	14.0	950	3670	3920	16.7	16.0	15.3	
25+35+50+60	1.99	2.78	3.97	4.76	-	-	3.6	13.5	14.0	950	3660	3920	16.7	15.9	15.3	
25+35+60+60	1.88	2.63	4.50	4.50	-	-	3.6	13.5	14.0	950	3660	3920	16.7	15.9	15.3	
25+50+50+50	1.93	3.86	3.86	3.86	-	-	3.6	13.5	14.0	950	3660	3920	16.7	15.9	15.3	
25+50+50+60	1.82	3.65	3.65	4.38	-	-	3.6	13.5	14.0	950	3650	3920	16.6	15.9	15.2	
25+50+60+60	1.73	3.46	4.15	4.15	-	-	3.6	13.5	14.0	950	3650	3920	16.6	15.9	15.2	
35+35+35+35	3.38	3.38	3.38	3.38	-	-	3.6	13.5	14.0	950	3670	3920	16.7	16.0	15.3	
35+35+35+50	3.05	3.05	3.05													



MULTI-SPLIT SYSTEM

Indoor unit combination		Heating capacity (kW)									Power consumption(W)			Standard current(A)		
		Room heating capacity						Total capacity			Min.	Standard	Max.	220V	230V	240V
		A	B	C	D	E	F	Min.	Standard	Max.						
4 room	35+35+50+60	2.63	2.63	3.75	4.50	-	-	3.6	13.5	14.0	950	3660	3920	16.7	15.9	15.3
	35+35+60+60	2.49	2.49	4.26	4.26	-	-	3.6	13.5	14.0	950	3650	3920	16.6	15.9	15.2
	35+50+50+50	2.55	3.65	3.65	3.65	-	-	3.6	13.5	14.0	950	3650	3920	16.6	15.9	15.2
	35+50+50+60	2.42	3.46	3.46	4.15	-	-	3.6	13.5	14.0	950	3650	3920	16.6	15.9	15.2
5 room	20+20+20+20+20	2.70	2.70	2.70	2.70	2.70	-	4.0	13.5	14.0	1050	3380	3470	15.4	14.7	14.1
	20+20+20+20+25	2.57	2.57	2.57	2.57	3.21	-	4.0	13.5	14.0	1050	3380	3470	15.4	14.7	14.1
	20+20+20+20+35	2.35	2.35	2.35	2.35	4.11	-	4.0	13.5	14.0	1050	3370	3470	15.3	14.7	14.1
	20+20+20+20+50	2.08	2.08	2.08	2.08	5.19	-	4.0	13.5	14.0	1050	3360	3470	15.3	14.6	14.0
	20+20+20+20+60	1.93	1.93	1.93	1.93	5.79	-	4.0	13.5	14.0	1050	3360	3470	15.3	14.6	14.0
	20+20+20+25+25	2.45	2.45	2.45	3.07	3.07	-	4.0	13.5	14.0	1050	3380	3470	15.4	14.7	14.1
	20+20+20+25+35	2.25	2.25	2.25	2.81	3.94	-	4.0	13.5	14.0	1050	3370	3470	15.3	14.7	14.1
	20+20+20+25+50	2.00	2.00	2.00	2.50	5.00	-	4.0	13.5	14.0	1050	3360	3470	15.3	14.6	14.0
	20+20+20+25+60	1.86	1.86	1.86	2.33	5.59	-	4.0	13.5	14.0	1050	3350	3470	15.2	14.6	14.0
	20+20+20+35+35	2.08	2.08	2.08	3.63	3.63	-	4.0	13.5	14.0	1050	3360	3470	15.3	14.6	14.0
	20+20+20+35+50	1.86	1.86	1.86	3.26	4.66	-	4.0	13.5	14.0	1050	3350	3470	15.2	14.6	14.0
	20+20+20+35+60	1.74	1.74	1.74	3.05	5.23	-	4.0	13.5	14.0	1050	3350	3470	15.2	14.6	14.0
	20+20+20+50+50	1.69	1.69	1.69	4.22	4.22	-	4.0	13.5	14.0	1050	3340	3470	15.2	14.5	13.9
	20+20+20+50+60	1.59	1.59	1.59	3.97	4.76	-	4.0	13.5	14.0	1050	3340	3470	15.2	14.5	13.9
	20+20+20+60+60	1.50	1.50	1.50	4.50	4.50	-	4.0	13.5	14.0	1050	3330	3470	15.2	14.5	13.9
	20+20+25+25+25	2.35	2.35	2.93	2.93	2.93	-	4.0	13.5	14.0	1050	3370	3470	15.3	14.7	14.1
	20+20+25+25+35	2.16	2.16	2.70	2.70	3.78	-	4.0	13.5	14.0	1050	3370	3470	15.3	14.7	14.1
	20+20+25+25+50	1.93	1.93	2.41	2.41	4.82	-	4.0	13.5	14.0	1050	3360	3470	15.3	14.6	14.0
	20+20+25+25+60	1.80	1.80	2.25	2.25	5.40	-	4.0	13.5	14.0	1050	3350	3470	15.2	14.6	14.0
	20+20+25+35+35	2.00	2.00	2.50	3.50	3.50	-	4.0	13.5	14.0	1050	3360	3470	15.3	14.6	14.0
	20+20+25+35+50	1.80	1.80	2.25	3.15	4.50	-	4.0	13.5	14.0	1050	3350	3470	15.2	14.6	14.0
	20+20+25+35+60	1.69	1.69	2.11	2.95	5.06	-	4.0	13.5	14.0	1050	3340	3470	15.2	14.5	13.9
	20+20+25+50+50	1.64	1.64	2.05	4.09	4.09	-	4.0	13.5	14.0	1050	3340	3470	15.2	14.5	13.9
	20+20+25+50+60	1.54	1.54	1.93	3.86	4.63	-	4.0	13.5	14.0	1050	3340	3470	15.2	14.5	13.9
	20+20+25+60+60	1.46	1.46	1.82	4.38	4.38	-	4.0	13.5	14.0	1050	3330	3470	15.2	14.5	13.9
	20+20+35+35+35	1.86	1.86	3.26	3.26	3.26	-	4.0	13.5	14.0	1050	3350	3470	15.2	14.6	14.0
	20+20+35+35+50	1.69	1.69	2.95	2.95	4.22	-	4.0	13.5	14.0	1050	3340	3470	15.2	14.5	13.9
	20+20+35+35+60	1.59	1.59	2.78	2.78	4.76	-	4.0	13.5	14.0	1050	3340	3470	15.2	14.5	13.9
	20+20+35+50+50	1.54	1.54	2.70	3.86	3.86	-	4.0	13.5	14.0	1050	3340	3470	15.2	14.5	13.9
	20+20+35+50+60	1.46	1.46	2.55	3.65	4.38	-	4.0	13.5	14.0	1050	3330	3470	15.2	14.5	13.9
	20+20+35+60+60	1.38	1.38	2.42	4.15	4.15	-	4.0	13.5	14.0	1050	3320	3470	15.1	14.4	13.8
	20+20+50+50+50	1.42	1.42	3.55	3.55	3.55	-	4.0	13.5	14.0	1050	3320	3470	15.1	14.4	13.8
	20+25+25+25+25	2.25	2.81	2.81	2.81	2.81	-	4.0	13.5	14.0	1050	3370	3470	15.3	14.7	14.1
	20+25+25+25+35	2.08	2.60	2.60	2.60	3.63	-	4.0	13.5	14.0	1050	3360	3470	15.3	14.6	14.0
	20+25+25+25+50	1.86	2.33	2.33	2.33	4.66	-	4.0	13.5	14.0	1050	3350	3470	15.2	14.6	14.0
	20+25+25+25+60	1.74	2.18	2.18	2.18	5.23	-	4.0	13.5	14.0	1050	3350	3470	15.2	14.6	14.0
	20+25+25+35+35	1.93	2.41	2.41	3.38	3.38	-	4.0	13.5	14.0	1050	3360	3470	15.3	14.6	14.0
	20+25+25+35+50	1.74	2.18	2.18	3.05	4.35	-	4.0	13.5	14.0	1050	3350	3470	15.2	14.6	14.0
	20+25+25+35+60	1.64	2.05	2.05	2.86	4.91	-	4.0	13.5	14.0	1050	3340	3470	15.2	14.5	13.9
	20+25+25+50+50	1.59	1.99	1.99	3.97	3.97	-	4.0	13.5	14.0	1050	3340	3470	15.2	14.5	13.9
	20+25+25+50+60	1.50	1.88	1.88	3.75	4.50	-	4.0	13.5	14.0	1050	3330	3470	15.2	14.5	13.9
	20+25+25+60+60	1.42	1.78	1.78	4.26	4.26	-	4.0	13.5	14.0	1050	3320	3470	15.1	14.4	13.8
	20+25+35+35+35	1.80	2.25	3.15	3.15	3.15	-	4.0	13.5	14.0	1050	3350	3470	15.2	14.6	14.0
	20+25+35+35+50	1.64	2.05	2.86	2.86	4.09	-	4.0	13.5	14.0	1050	3340	3470	15.2	14.5	13.9
	20+25+35+35+60	1.54	1.93	2.70	2.70	4.63	-	4.0	13.5	14.0	1050	3340	3470	15.2	14.5	13.9
	20+25+35+50+50	1.50	1.88	2.63	3.75	3.75	-	4.0	13.5	14.0	1050	3330	3470	15.2	14.5	13.9
	20+25+35+50+60	1.42	1.78	2.49	3.55	4.26	-	4.0	13.5	14.0	1050	3320	3470	15.1	14.4	13.8
	20+25+50+50+50	1.38	1.73	3.46	3.46	3.46	-	4.0	13.5	14.0	1050	3320	3470	15.1	14.4	13.8
20+35+35+35+35	1.69	2.95	2.95	2.95	2.95	-	4.0	13.5	14.0	1050	3340	3470	15.2	14.5	13.9	
20+35+35+35+50	1.54	2.70	2.70	2.70	3.86	-	4.0	13.5	14.0	1050	3340	3470	15.2	14.5	13.9	
20+35+35+35+60	1.46	2.55	2.55	2.55	4.38	-	4.0	13.5	14.0	1050	3330	3470	15.2	14.5	13.9	
20+35+35+50+50	1.42	2.49	2.49	3.55	3.55	-	4.0	13.5	14.0	1050	3320	3470	15.1	14.4	13.8	
25+25+25+25+25	2.70	2.70	2.70	2.70	2.70	-	4.0	13.5	14.0	1050	3370	3470	15.3	14.7	14.1	
25+25+25+25+35	2.50	2.50	2.50	2.50	3.50	-	4.0	13.5	14.0	1050	3360	3470	15.3	14.6	14.0	
25+25+25+25+50	2.25	2.25	2.25	2.25	4.50	-	4.0	13.5	14.0	1050	3350	3470	15.2	14.6	14.0	
25+25+25+25+60	2.11	2.11	2.11	2.11	5.06	-	4.0	13.5	14.0	1050	3340	3470	15.2	14.5	13.9	
25+25+25+35+35	2.33	2.33	2.33	3.26	3.26	-	4.0	13.5	14.0	1050	3350	3470	15.2	14.6	14.0	
25+25+25+35+50	2.11	2.11	2.11	2.95	4.22	-	4.0	13.5	14.0	1050	3340	3470	15.2	14.5	13.9	
25+25+25+35+60	1.99	1.99	1.99	2.78	4.76	-	4.0	13.5	14.0	1050	3340	3470	15.2	14.5	13.9	
25+25+25+50+50	1.93	1.93	1.93	3.86	3.86	-	4.0	13.5	14.0	1050	3340	3470	15.2	14.5	13.9	
25+25+25+50+60	1.82	1.82	1.82	3.65	4.38	-	4.0	13.5	14.0	1050	3330	3470	15.2	14.5	13.9	
25+25+25+60+60	1.73	1.73	1.73	4.15	4.15	-	4.0	13.5	14.0	1050	3320	3470	15.1	14.4	13.8	
25+25+35+35+35	2.18	2.18	3.05	3.05	3.05	-	4.0	13.5	14.0	1050	3350	3470	15.2	14.6	14.0	
25+25+35+35+50	1.99	1.99	2.78	2.78	3.97	-	4.0	13.5	14.0	1050	3340	3470	15.2	14.5	13.9	
25+25+35+35+60	1.88	1.88	2.63	2.63	4.50	-	4.0	13.5	14.0	1050	3330	3470	15.2	14.5	13.9	
25+25+35+50+50	1.82	1.82	2.55	3.65	3.65	-	4.0	13.5	14.0	1050	3330	3470	15.2	14.5	13.9	

COMBINATIONS

Indoor unit combination		Heating capacity (kW)									Power consumption(W)			Standard current(A)			
		Room heating capacity						Total capacity			Min.	Standard	Max.	220V	230V	240V	
		A	B	C	D	E	F	Min.	Standard	Max.							
Heating operation	6 room	20+20+20+20+20+20	2.25	2.25	2.25	2.25	2.25	2.25	4.5	13.5	14.0	1150	3260	3420	14.8	14.2	13.6
		20+20+20+20+20+25	2.16	2.16	2.16	2.16	2.16	2.70	4.5	13.5	14.0	1150	3250	3420	14.8	14.1	13.6
		20+20+20+20+20+35	2.00	2.00	2.00	2.00	2.00	3.50	4.5	13.5	14.0	1150	3250	3420	14.8	14.1	13.6
		20+20+20+20+20+50	1.80	1.80	1.80	1.80	1.80	4.50	4.5	13.5	14.0	1150	3250	3420	14.8	14.1	13.6
		20+20+20+20+20+60	1.69	1.69	1.69	1.69	1.69	5.06	4.5	13.5	14.0	1150	3240	3420	14.7	14.1	13.5
		20+20+20+20+25+25	2.08	2.08	2.08	2.08	2.60	2.60	4.5	13.5	14.0	1150	3250	3420	14.8	14.1	13.6
		20+20+20+20+25+35	1.93	1.93	1.93	1.93	2.41	3.38	4.5	13.5	14.0	1150	3250	3420	14.8	14.1	13.6
		20+20+20+20+25+50	1.74	1.74	1.74	1.74	2.18	4.35	4.5	13.5	14.0	1150	3240	3420	14.7	14.1	13.5
		20+20+20+20+25+60	1.64	1.64	1.64	1.64	2.05	4.91	4.5	13.5	14.0	1150	3240	3420	14.7	14.1	13.5
		20+20+20+20+35+35	1.80	1.80	1.80	1.80	3.15	3.15	4.5	13.5	14.0	1150	3250	3420	14.8	14.1	13.6
		20+20+20+20+35+50	1.64	1.64	1.64	1.64	2.86	4.09	4.5	13.5	14.0	1150	3240	3420	14.7	14.1	13.5
		20+20+20+20+35+60	1.54	1.54	1.54	1.54	2.70	4.63	4.5	13.5	14.0	1150	3230	3420	14.7	14.1	13.5
		20+20+20+20+50+50	1.50	1.50	1.50	1.50	3.75	3.75	4.5	13.5	14.0	1150	3230	3420	14.7	14.1	13.5
		20+20+20+20+50+60	1.42	1.42	1.42	1.42	3.55	4.26	4.5	13.5	14.0	1150	3230	3420	14.7	14.1	13.5
		20+20+20+25+25+25	2.00	2.00	2.00	2.50	2.50	2.50	4.5	13.5	14.0	1150	3250	3420	14.8	14.1	13.6
		20+20+20+25+25+35	1.86	1.86	1.86	2.33	2.33	3.26	4.5	13.5	14.0	1150	3250	3420	14.8	14.1	13.6
		20+20+20+25+25+50	1.69	1.69	1.69	2.11	2.11	4.22	4.5	13.5	14.0	1150	3240	3420	14.7	14.1	13.5
		20+20+20+25+25+60	1.59	1.59	1.59	1.99	1.99	4.76	4.5	13.5	14.0	1150	3240	3420	14.7	14.1	13.5
		20+20+20+25+35+35	1.74	1.74	1.74	2.18	3.05	3.05	4.5	13.5	14.0	1150	3240	3420	14.7	14.1	13.5
		20+20+20+25+35+50	1.59	1.59	1.59	1.99	2.78	3.97	4.5	13.5	14.0	1150	3240	3420	14.7	14.1	13.5
		20+20+20+25+35+60	1.50	1.50	1.50	1.88	2.63	4.50	4.5	13.5	14.0	1150	3230	3420	14.7	14.1	13.5
		20+20+20+25+50+50	1.46	1.46	1.46	1.82	3.65	3.65	4.5	13.5	14.0	1150	3230	3420	14.7	14.1	13.5
		20+20+20+25+50+60	1.38	1.38	1.38	1.73	3.46	4.15	4.5	13.5	14.0	1150	3220	3420	14.7	14.0	13.4
		20+20+20+35+35+35	1.64	1.64	1.64	2.86	2.86	2.86	4.5	13.5	14.0	1150	3240	3420	14.7	14.1	13.5
		20+20+20+35+35+50	1.50	1.50	1.50	2.63	2.63	3.75	4.5	13.5	14.0	1150	3230	3420	14.7	14.1	13.5
		20+20+20+35+35+60	1.42	1.42	1.42	2.49	2.49	4.26	4.5	13.5	14.0	1150	3230	3420	14.7	14.1	13.5
		20+20+20+35+50+50	1.38	1.38	1.38	2.42	3.46	3.46	4.5	13.5	14.0	1150	3220	3420	14.7	14.0	13.4
		20+20+25+25+25+25	1.93	1.93	2.41	2.41	2.41	2.41	4.5	13.5	14.0	1150	3250	3420	14.8	14.1	13.6
		20+20+25+25+25+35	1.80	1.80	2.25	2.25	2.25	3.15	4.5	13.5	14.0	1150	3250	3420	14.8	14.1	13.6
		20+20+25+25+25+50	1.64	1.64	2.05	2.05	2.05	4.09	4.5	13.5	14.0	1150	3240	3420	14.7	14.1	13.5
		20+20+25+25+25+60	1.54	1.54	1.93	1.93	1.93	4.63	4.5	13.5	14.0	1150	3230	3420	14.7	14.1	13.5
		20+20+25+25+35+35	1.69	1.69	2.11	2.11	2.95	2.95	4.5	13.5	14.0	1150	3240	3420	14.7	14.1	13.5
		20+20+25+25+35+50	1.54	1.54	1.93	1.93	2.70	3.86	4.5	13.5	14.0	1150	3230	3420	14.7	14.1	13.5
		20+20+25+25+35+60	1.46	1.46	1.82	1.82	2.55	4.38	4.5	13.5	14.0	1150	3230	3420	14.7	14.1	13.5
		20+20+25+25+50+50	1.42	1.42	1.78	1.78	3.55	3.55	4.5	13.5	14.0	1150	3230	3420	14.7	14.1	13.5
		20+20+25+25+50+60	1.59	1.59	1.99	2.78	2.78	2.78	4.5	13.5	14.0	1150	3240	3420	14.7	14.1	13.5
		20+20+25+35+35+35	1.46	1.46	1.82	2.55	2.55	3.65	4.5	13.5	14.0	1150	3230	3420	14.7	14.1	13.5
		20+20+25+35+35+60	1.38	1.38	1.73	2.42	2.42	4.15	4.5	13.5	14.0	1150	3220	3420	14.7	14.0	13.4
		20+20+35+35+35+35	1.50	1.50	2.63	2.63	2.63	2.63	4.5	13.5	14.0	1150	3230	3420	14.7	14.1	13.5
		20+20+35+35+35+50	1.38	1.38	2.42	2.42	2.42	3.46	4.5	13.5	14.0	1150	3220	3420	14.7	14.0	13.4
		20+25+25+25+25+25	1.86	2.33	2.33	2.33	2.33	2.33	4.5	13.5	14.0	1150	3250	3420	14.8	14.1	13.6
		20+25+25+25+25+35	1.74	2.18	2.18	2.18	2.18	3.05	4.5	13.5	14.0	1150	3240	3420	14.7	14.1	13.5
		20+25+25+25+25+50	1.59	1.99	1.99	1.99	1.99	3.97	4.5	13.5	14.0	1150	3240	3420	14.7	14.1	13.5
		20+25+25+25+25+60	1.50	1.88	1.88	1.88	1.88	4.50	4.5	13.5	14.0	1150	3230	3420	14.7	14.1	13.5
		20+25+25+25+35+35	1.64	2.05	2.05	2.05	2.86	2.86	4.5	13.5	14.0	1150	3240	3420	14.7	14.1	13.5
20+25+25+25+35+50	1.50	1.88	1.88	1.88	2.63	3.75	4.5	13.5	14.0	1150	3230	3420	14.7	14.1	13.5		
20+25+25+25+35+60	1.42	1.78	1.78	1.78	2.49	4.26	4.5	13.5	14.0	1150	3230	3420	14.7	14.1	13.5		
20+25+25+25+50+50	1.38	1.73	1.73	1.73	3.46	3.46	4.5	13.5	14.0	1150	3220	3420	14.7	14.0	13.4		
20+25+25+25+50+60	1.54	1.93	1.93	2.70	2.70	2.70	4.5	13.5	14.0	1150	3230	3420	14.7	14.1	13.5		
20+25+25+35+35+35	1.42	1.78	1.78	2.49	2.49	3.55	4.5	13.5	14.0	1150	3230	3420	14.7	14.1	13.5		
20+25+35+35+35+35	1.46	1.82	2.55	2.55	2.55	2.55	4.5	13.5	14.0	1150	3230	3420	14.7	14.1	13.5		
20+35+35+35+35+35	1.38	2.42	2.42	2.42	2.42	2.42	4.5	13.5	14.0	1150	3220	3420	14.7	14.0	13.4		
25+25+25+25+25+25	2.25	2.25	2.25	2.25	2.25	2.25	4.5	13.5	14.0	1150	3240	3420	14.7	14.1	13.5		
25+25+25+25+25+35	2.11	2.11	2.11	2.11	2.11	2.95	4.5	13.5	14.0	1150	3240	3420	14.7	14.1	13.5		
25+25+25+25+25+50	1.93	1.93	1.93	1.93	1.93	3.86	4.5	13.5	14.0	1150	3230	3420	14.7	14.1	13.5		
25+25+25+25+25+60	1.82	1.82	1.82	1.82	1.82	4.38	4.5	13.5	14.0	1150	3230	3420	14.7	14.1	13.5		
25+25+25+25+35+35	1.99	1.99	1.99	1.99	2.78	2.78	4.5	13.5	14.0	1150	3240	3420	14.7	14.1	13.5		
25+25+25+25+35+50	1.82	1.82	1.82	1.82	2.55	3.65	4.5	13.5	14.0	1150	3230	3420	14.7	14.1	13.5		
25+25+25+25+35+60	1.73	1.73	1.73	1.73	2.42	4.15	4.5	13.5	14.0	1150	3220	3420	14.7	14.0	13.4		
25+25+25+35+35+35	1.88	1.88	1.88	2.63	2.63	2.63	4.5	13.5	14.0	1150	3230	3420	14.7	14.1	13.5		
25+25+25+35+35+50	1.73	1.73	1.73	2.42	2.42	3.46	4.5	13.5	14.0	1150	3220	3420	14.7	14.0	13.4		
25+25+35+35+35+35	1.78	1.78	2.49	2.49	2.49	2.49	4.5	13.5	14.0	1150	3230	3420	14.7	14.1	13.5		

Indoor unit combination		Cooling capacity (kW)									Power consumption(W)			Standard current(A)			
		Room cooling capacity						Total capacity			Min.	Standard	Max.	220V	230V	240V	
		A	B	C	D	E	F	Min.	Standard	Max.							
Cooling operation	1 room	20	2.0	-	-	-	-	-	1.8	2.0	2.8	650	750	1100	3.4	3.3	3.2
		25	2.5	-	-	-	-	-	1.8	2.5	3.4	650	950	1350	4.4	4.2	4.0
		35	3.5	-	-	-	-	-	1.8	3.5	3.9	650	1400	1600	6.4	6.1	5.9
		50	5.0	-	-	-	-	-	1.8	5.0	6.1	650	2000	2500	9.2	8.8	8.4
	60	6.0	-	-	-	-	-	1.8	6.0	7.0	650	2450	3000	11.2	10.8	10.3	
	2 room	20+20	2.00	2.00	-	-	-	-	3.0	4.0	5.6	740	910	1460	4.2	4.0	3.8
		20+25	2.00	2.50	-	-	-	-	3.0	4.5	6.2	740	1050	1820	4.8	4.6	4.4
		20+35	2.00	3.50	-	-	-	-	3.0	5.5	6.7	740	1430	2020	6.6	6.3	6.0
		20+50	2.00	5.00	-	-	-	-	3.0	7.0	8.9	740	2180	2820	10.0	9.6	9.2
		20+60	2.00	6.00	-	-	-	-	3.0	8.0	9.8	740	2530	3360	11.6	11.1	10.6
		25+25	2.50	2.50	-	-	-	-	3.0	5.0	6.8	740	1350	2200	6.2	5.9	5.7



MULTI-SPLIT SYSTEM

Indoor unit combination		Cooling capacity (kW)									Power consumption(W)			Standard current(A)			
		Room cooling capacity						Total capacity			Min.	Standard	Max.	220V	230V	240V	
		A	B	C	D	E	F	Min.	Standard	Max.							
2 room	25+35	2.50	3.50	-	-	-	-	3.0	6.0	7.3	740	1720	2320	7.9	7.6	7.2	
	25+50	2.50	5.00	-	-	-	-	3.0	7.5	9.5	740	2350	3220	10.8	10.3	9.9	
	25+60	2.50	6.00	-	-	-	-	3.0	8.5	9.8	740	2680	3360	12.3	11.8	11.3	
	35+35	3.50	3.50	-	-	-	-	3.0	7.0	7.8	740	2180	2820	10.0	9.6	9.2	
	35+50	3.50	5.00	-	-	-	-	3.0	8.5	10.0	740	2680	3620	12.3	11.8	11.3	
	35+60	3.50	6.00	-	-	-	-	3.0	9.5	10.9	740	3120	3990	14.3	13.7	13.1	
	50+50	5.00	5.00	-	-	-	-	3.0	10.0	12.2	740	3350	4450	15.4	14.7	14.1	
	50+60	5.00	6.00	-	-	-	-	3.0	11.0	12.5	740	3685	4520	16.9	16.2	15.5	
	60+60	6.00	6.00	-	-	-	-	3.0	12.0	12.5	740	4200	4520	19.3	18.4	17.7	
	3 room	20+20+20	2.00	2.00	2.00	-	-	-	3.7	6.0	8.4	880	1460	2560	6.7	6.4	6.1
		20+20+25	2.00	2.00	2.50	-	-	-	3.7	6.5	9.0	880	1650	2700	7.6	7.2	6.9
		20+20+35	2.00	2.00	3.50	-	-	-	3.7	7.5	9.5	880	1980	3120	9.1	8.7	8.3
		20+20+50	2.00	2.00	5.00	-	-	-	3.7	9.0	11.7	880	2600	4120	11.9	11.4	10.9
		20+20+60	2.00	2.00	6.00	-	-	-	3.7	10.0	12.6	880	3120	4680	14.3	13.7	13.1
		20+25+25	2.00	2.50	2.50	-	-	-	3.7	7.0	9.6	880	1850	3210	8.5	8.1	7.8
		20+25+35	2.00	2.50	3.50	-	-	-	3.7	8.0	10.1	880	2320	3630	10.7	10.2	9.8
		20+25+50	2.00	2.50	5.00	-	-	-	3.7	9.5	12.3	880	2980	4510	13.7	13.1	12.5
		20+25+60	2.00	2.50	6.00	-	-	-	3.7	10.5	12.8	880	3590	4800	16.5	15.8	15.1
20+35+35		2.00	3.50	3.50	-	-	-	3.7	9.0	10.6	880	2780	4120	12.8	12.2	11.7	
20+35+50		2.00	3.50	5.00	-	-	-	3.7	10.5	12.8	880	3590	4800	16.5	15.8	15.1	
20+35+60		2.00	3.50	6.00	-	-	-	3.7	11.5	12.8	880	3950	4800	18.1	17.3	16.6	
20+50+50		2.00	5.00	5.00	-	-	-	3.7	12.0	12.8	880	4230	4800	19.4	18.6	17.8	
20+50+60		1.92	4.81	5.77	-	-	-	3.7	12.5	12.8	880	4450	4800	20.4	19.5	18.7	
20+60+60		1.79	5.36	5.36	-	-	-	3.7	12.5	12.8	880	4450	4800	20.4	19.5	18.7	
25+25+25		2.50	2.50	2.50	-	-	-	3.7	7.5	10.2	880	2030	3640	9.3	8.9	8.5	
25+25+35		2.50	2.50	3.50	-	-	-	3.7	8.5	10.7	880	2520	3900	11.6	11.1	10.6	
25+25+50		2.50	2.50	5.00	-	-	-	3.7	10.0	12.8	880	3260	4800	15.0	14.3	13.7	
25+25+60		2.50	2.50	6.00	-	-	-	3.7	11.0	12.8	880	3720	4800	17.1	16.3	15.7	
25+35+35		2.50	3.50	3.50	-	-	-	3.7	9.5	11.2	880	2980	4510	13.7	13.1	12.5	
25+35+50		2.50	3.50	5.00	-	-	-	3.7	11.0	12.8	880	3720	4800	17.1	16.3	15.7	
25+35+60		2.50	3.50	6.00	-	-	-	3.7	12.0	12.8	880	4230	4800	19.4	18.6	17.8	
25+50+50		2.50	5.00	5.00	-	-	-	3.7	12.5	12.8	880	4450	4800	20.4	19.5	18.7	
25+50+60		2.31	4.63	5.56	-	-	-	3.7	12.5	12.8	880	4450	4800	20.4	19.5	18.7	
25+60+60		2.16	5.17	5.17	-	-	-	3.7	12.5	12.8	880	4450	4800	20.4	19.5	18.7	
35+35+35		3.50	3.50	3.50	-	-	-	3.7	10.5	11.7	880	3590	4180	16.5	15.8	15.1	
35+35+50		3.50	3.50	5.00	-	-	-	3.7	12.0	12.8	880	4230	4800	19.4	18.6	17.8	
35+35+60		3.37	3.37	5.77	-	-	-	3.7	12.5	12.8	880	4450	4800	20.4	19.5	18.7	
35+50+50		3.24	4.63	4.63	-	-	-	3.7	12.5	12.8	880	4450	4800	20.4	19.5	18.7	
35+50+60		3.02	4.31	5.17	-	-	-	3.7	12.5	12.8	880	4450	4800	20.2	19.3	18.5	
35+60+60	2.82	4.84	4.84	-	-	-	3.7	12.5	12.8	880	4450	4800	20.2	19.3	18.5		
50+50+50	4.17	4.17	4.17	-	-	-	3.7	12.5	12.8	880	4440	4800	20.4	19.5	18.7		
50+50+60	3.91	3.91	4.69	-	-	-	3.7	12.5	12.8	880	4440	4800	20.4	19.5	18.7		
50+60+60	3.68	4.41	4.41	-	-	-	3.7	12.5	12.8	880	4430	4800	20.3	19.5	18.6		
60+60+60	4.17	4.17	4.17	-	-	-	3.7	12.5	12.8	880	4430	4800	20.3	19.5	18.6		
4 room	20+20+20+20	2.00	2.00	2.00	2.00	-	-	4.4	8.0	11.2	1100	2050	3680	9.3	8.9	8.6	
	20+20+20+25	2.00	2.00	2.00	2.50	-	-	4.4	8.5	11.8	1100	2320	3890	10.6	10.1	9.7	
	20+20+20+35	2.00	2.00	2.00	3.50	-	-	4.4	9.5	12.3	1100	2820	4530	12.8	12.3	11.8	
	20+20+20+50	2.00	2.00	2.00	5.00	-	-	4.4	11.0	13.0	1100	3480	4800	15.8	15.1	14.5	
	20+20+20+60	2.00	2.00	2.00	6.00	-	-	4.4	12.0	13.0	1100	3980	4800	18.1	17.3	16.6	
	20+20+25+25	2.00	2.00	2.50	2.50	-	-	4.4	9.0	12.4	1100	2520	4590	11.5	11.0	10.5	
	20+20+25+35	2.00	2.00	2.50	3.50	-	-	4.4	10.0	12.9	1100	3120	4780	14.2	13.6	13.0	
	20+20+25+50	2.00	2.00	2.50	5.00	-	-	4.4	11.5	13.0	1100	3720	4800	16.9	16.2	15.5	
	20+20+25+60	2.00	2.00	2.50	6.00	-	-	4.4	12.5	13.0	1100	4600	4800	20.9	20.0	19.2	
	20+20+35+35	2.00	2.00	3.50	3.50	-	-	4.4	11.0	13.0	1100	3480	4800	15.8	15.1	14.5	
	20+20+35+50	2.00	2.00	3.50	5.00	-	-	4.4	12.5	13.0	1100	4600	4800	20.9	20.0	19.2	
	20+20+35+60	1.85	1.85	3.24	5.56	-	-	4.4	12.5	13.0	1100	4590	4800	20.9	20.0	19.1	
	20+20+50+50	1.79	1.79	4.46	4.46	-	-	4.4	12.5	13.0	1100	4590	4800	20.9	20.0	19.1	
	20+20+50+60	1.67	1.67	4.17	5.00	-	-	4.4	12.5	13.0	1100	4590	4800	20.9	20.0	19.1	
	20+20+60+60	1.56	1.56	4.69	4.69	-	-	4.4	12.5	13.0	1100	4580	4800	20.8	19.9	19.1	
	20+25+25+25	2.00	2.50	2.50	2.50	-	-	4.4	9.5	13.0	1100	2820	4800	12.8	12.3	11.8	
	20+25+25+35	2.00	2.50	2.50	3.50	-	-	4.4	10.5	13.0	1100	3340	4800	15.2	14.5	13.9	
	20+25+25+50	2.00	2.50	2.50	5.00	-	-	4.4	12.0	13.0	1100	3980	4800	18.1	17.3	16.6	
	20+25+25+60	1.92	2.40	2.40	5.77	-	-	4.4	12.5	13.0	1100	4600	4800	20.9	20.0	19.2	
	20+25+35+35	2.00	2.50	3.50	3.50	-	-	4.4	11.5	13.0	1100	3720	4800	16.9	16.2	15.5	
	20+25+35+50	1.92	2.40	3.37	4.81	-	-	4.4	12.5	13.0	1100	4600	4800	20.9	20.0	19.2	
	20+25+35+60	1.79	2.23	3.13	5.36	-	-	4.4	12.5	13.0	1100	4590	4800	20.9	20.0	19.1	
	20+25+50+50	1.72	2.16	4.31	4.31	-	-	4.4	12.5	13.0	1100	4590	4800	20.9	20.0	19.1	
	20+25+50+60	1.61	2.02	4.03	4.84	-	-	4.4	12.5	13.0	1100	4580	4800	20.8	19.9	19.1	
	20+25+60+60	1.52	1.89	4.55	4.55	-	-	4.4	12.5	13.0	1100	4580	4800	20.8	19.9	19.1	
	20+35+35+35	2.00	3.50	3.50	3.50	-	-	4.4	12.5	13.0	1100	4600	4800	20.9	20.0	19.2	
	20+35+35+50	1.79	3.13	3.13	4.46	-	-	4.4	12.5	13.0	1100	4590	4800	20.9	20.0	19.1	
	20+35+35+60	1.67	2.92	2.92	5.00	-	-	4.4	12.5	13.0	1100	4590	4800	20.9	20.0	19.1	
	20+35+50+50	1.61	2.82	4.03	4.03	-	-	4.4	12.5	13.0	1100	4580	4800	20.8	19.9	19.1	
	20+35+50+60	1.52	2.65	3.79	4.55	-	-	4.4	12.5	13.0	1100	4580	4800	20.8	19.9	19.1	
20+35+60+60	1.43	2.50	4.29	4.29	-	-	5.4	12.5	13.0	1100	4570	4800	20.6	19.7	18.9		
20+50+50+50	1.47	3.68	3.68	3.68	-	-	4.4	12.5									

COMBINATIONS

Indoor unit combination		Cooling capacity (kW)									Power consumption(W)			Standard current(A)			
		Room cooling capacity						Total capacity			Min.	Standard	Max.	220V	230V	240V	
		A	B	C	D	E	F	Min.	Standard	Max.							
Cooling operation	4 room	20+50+60+60	1.32	3.29	3.95	3.95	-	-	4.4	12.5	13.0	1100	4560	4800	20.7	19.8	19.0
		25+25+25+25	2.50	2.50	2.50	2.50	-	-	4.4	10.0	13.0	1100	3120	4800	14.2	13.6	13.0
		25+25+25+35	2.50	2.50	2.50	3.50	-	-	4.4	11.0	13.0	1100	3480	4800	15.8	15.1	14.5
		25+25+25+50	2.50	2.50	2.50	5.00	-	-	4.4	12.5	13.0	1100	4600	4800	20.9	20.0	19.2
		25+25+25+60	2.31	2.31	2.31	5.56	-	-	4.4	12.5	13.0	1100	4590	4800	20.9	20.0	19.1
		25+25+35+35	2.50	2.50	3.50	3.50	-	-	4.4	12.0	13.0	1100	3980	4800	18.1	17.3	16.6
		25+25+35+50	2.31	2.31	3.24	4.63	-	-	4.4	12.5	13.0	1100	4590	4800	20.9	20.0	19.1
		25+25+35+60	2.16	2.16	3.02	5.17	-	-	4.4	12.5	13.0	1100	4590	4800	20.9	20.0	19.1
		25+25+50+50	2.08	2.08	4.17	4.17	-	-	4.4	12.5	13.0	1100	4590	4800	20.9	20.0	19.1
		25+25+50+60	1.95	1.95	3.91	4.69	-	-	4.4	12.5	13.0	1100	4580	4800	20.8	19.9	19.1
		25+25+60+60	1.84	1.84	4.41	4.41	-	-	4.4	12.5	13.0	1100	4580	4800	20.8	19.9	19.1
		25+35+35+35	2.40	3.37	3.37	3.37	-	-	4.4	12.5	13.0	1100	4600	4800	20.9	20.0	19.2
		25+35+35+50	2.16	3.02	3.02	4.31	-	-	4.4	12.5	13.0	1100	4590	4800	20.9	20.0	19.1
		25+35+35+60	2.02	2.82	2.82	4.84	-	-	4.4	12.5	13.0	1100	4580	4800	20.8	19.9	19.1
		25+35+50+50	1.95	2.73	3.91	3.91	-	-	4.4	12.5	13.0	1100	4580	4800	20.8	19.9	19.1
		25+35+50+60	1.84	2.57	3.68	4.41	-	-	4.4	12.5	13.0	1100	4580	4800	20.8	19.9	19.1
		25+35+60+60	1.74	2.43	4.17	4.17	-	-	4.4	12.5	13.0	1100	4570	4800	20.8	19.9	19.1
		25+50+50+50	1.79	3.57	3.57	3.57	-	-	4.4	12.5	13.0	1100	4570	4800	20.8	19.9	19.1
		25+50+50+60	1.69	3.38	3.38	4.05	-	-	4.4	12.5	13.0	1100	4570	4800	20.8	19.9	19.1
		25+50+60+60	1.60	3.21	3.85	3.85	-	-	4.4	12.5	13.0	1100	4560	4800	20.7	19.8	19.0
	35+35+35+35	3.13	3.13	3.13	3.13	-	-	4.4	12.5	13.0	1100	4590	4800	20.9	20.0	19.1	
	35+35+35+50	2.82	2.82	2.82	4.03	-	-	4.4	12.5	13.0	1100	4580	4800	20.8	19.9	19.1	
	35+35+35+60	2.65	2.65	2.65	4.55	-	-	4.4	12.5	13.0	1100	4580	4800	20.8	19.9	19.1	
	35+35+50+50	2.57	2.57	3.68	3.68	-	-	4.4	12.5	13.0	1100	4580	4800	20.8	19.9	19.1	
	35+35+50+60	2.43	2.43	3.47	4.17	-	-	4.4	12.5	13.0	1100	4570	4800	20.8	19.9	19.1	
	35+35+60+60	2.30	2.30	3.95	3.95	-	-	4.4	12.5	13.0	1100	4560	4800	20.7	19.8	19.0	
	35+50+50+50	2.36	3.38	3.38	3.38	-	-	4.4	12.5	13.0	1100	4570	4800	20.8	19.9	19.1	
	35+50+50+60	2.24	3.21	3.21	3.85	-	-	4.4	12.5	13.0	1100	4560	4800	20.7	19.8	19.0	
	5 room	20+20+20+20+20	2.00	2.00	2.00	2.00	2.00	-	5.1	10.0	13.5	1210	2880	4800	13.1	12.5	12.0
		20+20+20+20+25	2.00	2.00	2.00	2.00	2.50	-	5.1	10.5	13.5	1210	3120	4800	14.2	13.6	13.0
		20+20+20+20+35	2.00	2.00	2.00	2.00	3.50	-	5.1	11.5	13.5	1210	3620	4800	16.5	15.8	15.1
		20+20+20+20+50	1.92	1.92	1.92	1.92	4.81	-	5.1	12.5	13.5	1210	4320	4800	19.7	18.8	18.0
		20+20+20+20+60	1.79	1.79	1.79	1.79	5.36	-	5.1	12.5	13.5	1210	4310	4800	19.6	18.8	18.0
		20+20+20+25+25	2.00	2.00	2.00	2.50	2.50	-	5.1	11.0	13.5	1210	3320	4800	15.1	14.4	13.8
		20+20+20+25+35	2.00	2.00	2.00	2.50	3.50	-	5.1	12.0	13.5	1210	3990	4800	18.2	17.4	16.6
20+20+20+25+50		1.85	1.85	1.85	2.31	4.63	-	5.1	12.5	13.5	1210	4320	4800	19.7	18.8	18.0	
20+20+20+25+60		1.72	1.72	1.72	2.16	5.17	-	5.1	12.5	13.5	1210	4310	4800	19.6	18.8	18.0	
20+20+20+35+35		1.92	1.92	1.92	3.37	3.37	-	5.1	12.5	13.5	1210	4320	4800	19.7	18.8	18.0	
20+20+20+35+50		1.72	1.72	1.72	3.02	4.31	-	5.1	12.5	13.5	1210	4310	4800	19.6	18.8	18.0	
20+20+20+35+60		1.61	1.61	1.61	2.82	4.84	-	5.1	12.5	13.5	1210	4300	4800	19.6	18.7	17.9	
20+20+20+50+50		1.56	1.56	1.56	3.91	3.91	-	5.1	12.5	13.5	1210	4300	4800	19.6	18.7	17.9	
20+20+20+50+60		1.47	1.47	1.47	3.68	4.41	-	5.1	12.5	13.5	1210	4290	4800	19.5	18.7	17.9	
20+20+20+60+60		1.39	1.39	1.39	4.17	4.17	-	5.1	12.5	13.5	1210	4280	4800	19.5	18.6	17.9	
20+20+25+25+25		2.00	2.00	2.50	2.50	2.50	-	5.1	11.5	13.5	1210	3620	4800	16.5	15.8	15.1	
20+20+25+25+35		2.00	2.00	2.50	2.50	3.50	-	5.1	12.5	13.5	1210	4330	4800	19.7	18.8	18.1	
20+20+25+25+50		1.79	1.79	2.23	2.23	4.46	-	5.1	12.5	13.5	1210	4310	4800	19.6	18.8	18.0	
20+20+25+25+60		1.67	1.67	2.08	2.08	5.00	-	5.1	12.5	13.5	1210	4300	4800	19.6	18.7	17.9	
20+20+25+35+35		1.85	1.85	2.31	3.24	3.24	-	5.1	12.5	13.5	1210	4320	4800	19.7	18.8	18.0	
20+20+25+35+50		1.67	1.67	2.08	2.92	4.17	-	5.1	12.5	13.5	1210	4300	4800	19.6	18.7	17.9	
20+20+25+35+60		1.56	1.56	1.95	2.73	4.69	-	5.1	12.5	13.5	1210	4300	4800	19.6	18.7	17.9	
20+20+25+50+50		1.52	1.52	1.89	3.79	3.79	-	5.1	12.5	13.5	1210	4290	4800	19.5	18.7	17.9	
20+20+25+50+60		1.43	1.43	1.79	3.57	4.29	-	5.1	12.5	13.5	1210	4280	4800	19.5	18.6	17.9	
20+20+25+60+60		1.35	1.35	1.69	4.05	4.05	-	5.1	12.5	13.5	1210	4280	4800	19.5	18.6	17.9	
20+20+35+35+35		1.72	1.72	3.02	3.02	3.02	-	5.1	12.5	13.5	1210	4310	4800	19.6	18.8	18.0	
20+20+35+35+50		1.56	1.56	2.73	2.73	3.91	-	5.1	12.5	13.5	1210	4300	4800	19.6	18.7	17.9	
20+20+35+35+60		1.47	1.47	2.57	2.57	4.41	-	5.1	12.5	13.5	1210	4290	4800	19.5	18.7	17.9	
20+20+35+50+50		1.43	1.43	2.50	3.57	3.57	-	5.1	12.5	13.5	1210	4280	4800	19.5	18.6	17.9	
20+20+35+50+60		1.35	1.35	2.36	3.38	4.05	-	5.1	12.5	13.5	1210	4280	4800	19.5	18.6	17.9	
20+20+35+60+60		1.28	1.28	2.24	3.85	3.85	-	5.1	12.5	13.5	1210	4270	4800	19.4	18.6	17.8	
20+20+50+50+50		1.32	1.32	3.29	3.29	3.29	-	5.1	12.5	13.5	1210	4270	4800	19.4	18.6	17.8	
20+25+25+25+25		2.00	2.50	2.50	2.50	2.50	-	5.1	12.0	13.5	1210	3990	4800	18.2	17.4	16.6	
20+25+25+25+35		1.92	2.40	2.40	2.40	3.37	-	5.1	12.5	13.5	1210	4320	4800	19.7	18.8	18.0	
20+25+25+25+50		1.72	2.16	2.16	2.16	4.31	-	5.1	12.5	13.5	1210	4310	4800	19.6	18.8	18.0	
20+25+25+25+60	1.61	2.02	2.02	2.02	4.84	-	5.1	12.5	13.5	1210	4300	4800	19.6	18.7	17.9		
20+25+25+35+35	1.79	2.23	2.23	3.13	3.13	-	5.1	12.5	13.5	1210	4310	4800	19.6	18.8	18.0		
20+25+25+35+50	1.61	2.02	2.02	2.82	4.03	-	5.1	12.5	13.5	1210	4300	4800	19.6	18.7	17.9		
20+25+25+35+60	1.52	1.89	1.89	2.65	4.55	-	5.1	12.5	13.5	1210	4290	4800	19.5	18.7	17.9		
20+25+25+50+50	1.47	1.84	1.84	3.68	3.68	-	5.1	12.5	13.5	1210	4290	4800	19.5	18.7	17.9		
20+25+25+50+60	1.39	1.74	1.74	3.47	4.17	-	5.1	12.5	13.5	1210	4280	4800	19.5	18.6	17.9		
20+25+25+60+60	1.32	1.64	1.64	3.95	3.95	-	5.1	12.5	13.5	1210	4270	4800	19.4	18.6	17.8		
20+25+35+35+35	1.67	2.08	2.92	2.92	2.92	-	5.1	12.5	13.5	1210	4300	4800	19.6	18.7	17.9		
20+25+35+35+50	1.52	1.89	2.65	2.65	3.79	-	5.1	12.5	13.5	1210	4290	4800	19.5	18.7	17.9		
20+25+35+35+60	1.43	1.79	2.50	2.50	4.29	-	5.1	12.5	13.5	1210	4280	4800	19.5	18.6	17.9		
20+25+35+50+50	1.39	1.74	2.43	3.47	3.47	-	5.1	12.5	13.5	1210	4280	4800	19.5	18.6	17.9		
20+25+35+50+60	1.32	1.64	2.30	3.29	3.95	-	5.1	12.5	13.5	1210	4270	4800	19.4	18.6	17.8		
20+25+50+50+50	1.28	1.60	3.21	3.21	3.21	-	5.1	12.5	13.5	1210	4270	4800	19.4	18.6	17.8		
20+35+35+35+35	1.56	2.73	2.73	2.73	2.73	-	5.1	12.5	13.5	1210	4300	4800	19.6	18.7	17.9		



MULTI-SPLIT SYSTEM

Indoor unit combination		Cooling capacity (kW)										Power consumption(W)			Standard current(A)		
		Room cooling capacity						Total capacity				Min.	Standard	Max.	220V	230V	240V
		A	B	C	D	E	F	Min.	Standard	Max.							
5 room	20+35+35+35+50	1.43	2.50	2.50	2.50	3.57	-	5.1	12.5	13.5	1210	4280	4800	19.5	18.6	17.9	
	20+35+35+35+60	1.35	2.36	2.36	2.36	4.05	-	5.1	12.5	13.5	1210	4280	4800	19.5	18.6	17.9	
	20+35+35+50+50	1.32	2.30	2.30	3.29	3.29	-	5.1	12.5	13.5	1210	4270	4800	19.4	18.6	17.8	
	25+25+25+25+25	2.50	2.50	2.50	2.50	2.50	-	5.1	12.5	13.5	1210	4330	4800	19.7	18.8	18.1	
	25+25+25+25+35	2.31	2.31	2.31	2.31	3.24	-	5.1	12.5	13.5	1210	4320	4800	19.7	18.8	18.0	
	25+25+25+25+50	2.08	2.08	2.08	2.08	4.17	-	5.1	12.5	13.5	1210	4300	4800	19.6	18.7	17.9	
	25+25+25+25+60	1.95	1.95	1.95	1.95	4.69	-	5.1	12.5	13.5	1210	4300	4800	19.6	18.7	17.9	
	25+25+25+35+35	2.16	2.16	2.16	3.02	3.02	-	5.1	12.5	13.5	1210	4310	4800	19.6	18.8	18.0	
	25+25+25+35+50	1.95	1.95	1.95	2.73	3.91	-	5.1	12.5	13.5	1210	4300	4800	19.6	18.7	17.9	
	25+25+25+35+60	1.84	1.84	1.84	2.57	4.41	-	5.1	12.5	13.5	1210	4290	4800	19.5	18.7	17.9	
	25+25+25+50+50	1.79	1.79	1.79	3.57	3.57	-	5.1	12.5	13.5	1210	4280	4800	19.5	18.6	17.9	
	25+25+25+50+60	1.69	1.69	1.69	3.38	4.05	-	5.1	12.5	13.5	1210	4280	4800	19.5	18.6	17.9	
	25+25+25+60+60	1.60	1.60	1.60	3.85	3.85	-	5.1	12.5	13.5	1210	4270	4800	19.4	18.6	17.8	
	25+25+35+35+35	2.02	2.02	2.82	2.82	2.82	-	5.1	12.5	13.5	1210	4300	4800	19.6	18.7	17.9	
	25+25+35+35+50	1.84	1.84	2.57	2.57	3.68	-	5.1	12.5	13.5	1210	4290	4800	19.5	18.7	17.9	
	25+25+35+35+60	1.74	1.74	2.43	2.43	4.17	-	5.1	12.5	13.5	1210	4280	4800	19.5	18.6	17.9	
	25+25+35+50+50	1.69	1.69	2.36	3.38	3.38	-	5.1	12.5	13.5	1210	4280	4800	19.5	18.6	17.9	
	25+25+35+50+60	1.60	1.60	2.24	3.21	3.85	-	5.1	12.5	13.5	1210	4270	4800	19.4	18.6	17.8	
	25+35+35+35+35	1.89	2.65	2.65	2.65	2.65	-	5.1	12.5	13.5	1210	4290	4800	19.5	18.7	17.9	
	25+35+35+35+50	1.74	2.43	2.43	2.43	3.47	-	5.1	12.5	13.5	1210	4280	4800	19.5	18.6	17.9	
25+35+35+35+60	1.64	2.30	2.30	2.30	3.95	-	5.1	12.5	13.5	1210	4270	4800	19.4	18.6	17.8		
25+35+35+50+50	1.60	2.24	2.24	3.21	3.21	-	5.1	12.5	13.5	1210	4270	4800	19.4	18.6	17.8		
35+35+35+35+35	2.50	2.50	2.50	2.50	2.50	-	5.1	12.5	13.5	1210	4280	4800	19.5	18.6	17.9		
35+35+35+35+50	2.30	2.30	2.30	2.30	3.29	-	5.1	12.5	13.5	1210	4270	4800	19.4	18.6	17.8		
Cooling operation	20+20+20+20+20+20	2.00	2.00	2.00	2.00	2.00	2.00	5.5	12.0	13.8	1280	3660	4620	16.7	15.9	15.3	
	20+20+20+20+20+25	2.00	2.00	2.00	2.00	2.00	2.50	5.5	12.5	14.0	1280	3900	4800	17.7	17.0	16.3	
	20+20+20+20+20+35	1.85	1.85	1.85	1.85	1.85	3.24	5.5	12.5	14.0	1280	3890	4800	17.7	16.9	16.2	
	20+20+20+20+20+50	1.67	1.67	1.67	1.67	1.67	4.17	5.5	12.5	14.0	1280	3860	4800	17.6	16.8	16.1	
	20+20+20+20+20+60	1.56	1.56	1.56	1.56	1.56	4.69	5.5	12.5	14.0	1280	3860	4800	17.6	16.8	16.1	
	20+20+20+20+25+25	1.92	1.92	1.92	1.92	2.40	2.40	5.5	12.5	14.0	1280	3900	4800	17.7	17.0	16.3	
	20+20+20+20+25+35	1.79	1.79	1.79	1.79	2.23	3.13	5.5	12.5	14.0	1280	3880	4800	17.7	16.9	16.2	
	20+20+20+20+25+50	1.61	1.61	1.61	1.61	2.02	4.03	5.5	12.5	14.0	1280	3860	4800	17.6	16.8	16.1	
	20+20+20+20+25+60	1.52	1.52	1.52	1.52	1.89	4.55	5.5	12.5	14.0	1280	3850	4800	17.5	16.8	16.1	
	20+20+20+20+35+35	1.67	1.67	1.67	1.67	2.92	2.92	5.5	12.5	14.0	1280	3860	4800	17.6	16.8	16.1	
	20+20+20+20+35+50	1.52	1.52	1.52	1.52	2.65	3.79	5.5	12.5	14.0	1280	3850	4800	17.5	16.8	16.1	
	20+20+20+20+35+60	1.43	1.43	1.43	1.43	2.50	4.29	5.5	12.5	14.0	1280	3830	4800	17.4	16.7	16.0	
	20+20+20+20+50+50	1.39	1.39	1.39	1.39	3.47	3.47	5.5	12.5	14.0	1280	3820	4800	17.4	16.6	15.9	
	20+20+20+20+50+60	1.32	1.32	1.32	1.32	3.29	3.95	5.5	12.5	14.0	1280	3800	4800	17.3	16.5	15.8	
	20+20+20+25+25+25	1.85	1.85	1.85	2.31	2.31	2.31	5.5	12.5	14.0	1280	3890	4800	17.7	16.9	16.2	
	20+20+20+25+25+35	1.72	1.72	1.72	2.16	2.16	3.02	5.5	12.5	14.0	1280	3870	4800	17.6	16.8	16.1	
	20+20+20+25+25+50	1.56	1.56	1.56	1.95	1.95	3.91	5.5	12.5	14.0	1280	3860	4800	17.6	16.8	16.1	
	20+20+20+25+25+60	1.47	1.47	1.47	1.84	1.84	4.41	5.5	12.5	14.0	1280	3840	4800	17.5	16.7	16.0	
	20+20+20+25+35+35	1.61	1.61	1.61	2.02	2.82	2.82	5.5	12.5	14.0	1280	3860	4800	17.6	16.8	16.1	
	20+20+20+25+35+50	1.47	1.47	1.47	1.84	2.57	3.68	5.5	12.5	14.0	1280	3840	4800	17.5	16.7	16.0	
	20+20+20+25+35+60	1.39	1.39	1.39	1.74	2.43	4.17	5.5	12.5	14.0	1280	3820	4800	17.4	16.6	15.9	
	20+20+20+25+50+50	1.35	1.35	1.35	1.69	3.38	3.38	5.5	12.5	14.0	1280	3810	4800	17.3	16.6	15.9	
	20+20+20+25+50+60	1.28	1.28	1.28	1.60	3.21	3.85	5.5	12.5	14.0	1280	3800	4800	17.3	16.5	15.8	
	20+20+20+35+35+35	1.52	1.52	1.52	2.65	2.65	2.65	5.5	12.5	14.0	1280	3850	4800	17.5	16.8	16.1	
	20+20+20+35+35+50	1.39	1.39	1.39	2.43	2.43	3.47	5.5	12.5	14.0	1280	3820	4800	17.4	16.6	15.9	
	20+20+20+35+35+60	1.32	1.32	1.32	2.30	2.30	3.95	5.5	12.5	14.0	1280	3800	4800	17.3	16.5	15.8	
	20+20+20+35+50+50	1.28	1.28	1.28	2.24	3.21	3.21	5.5	12.5	14.0	1280	3800	4800	17.3	16.5	15.8	
	20+20+25+25+25+25	1.79	1.79	2.23	2.23	2.23	2.23	5.5	12.5	14.0	1280	3880	4800	17.7	16.9	16.2	
	20+20+25+25+25+35	1.67	1.67	2.08	2.08	2.08	2.92	5.5	12.5	14.0	1280	3860	4800	17.6	16.8	16.1	
	20+20+25+25+25+50	1.52	1.52	1.89	1.89	1.89	3.79	5.5	12.5	14.0	1280	3850	4800	17.5	16.8	16.1	
	20+20+25+25+25+60	1.43	1.43	1.79	1.79	1.79	4.29	5.5	12.5	14.0	1280	3830	4800	17.4	16.7	16.0	
	20+20+25+25+35+35	1.56	1.56	1.95	1.95	2.73	2.73	5.5	12.5	14.0	1280	3860	4800	17.6	16.8	16.1	
	20+20+25+25+35+50	1.43	1.43	1.79	1.79	2.50	3.57	5.5	12.5	14.0	1280	3830	4800	17.4	16.7	16.0	
	20+20+25+25+35+60	1.35	1.35	1.69	1.69	2.36	4.05	5.5	12.5	14.0	1280	3810	4800	17.3	16.6	15.9	
	20+20+25+25+50+50	1.32	1.32	1.64	1.64	3.29	3.29	5.5	12.5	14.0	1280	3800	4800	17.3	16.5	15.8	
	20+20+25+25+50+60	1.47	1.47	1.84	2.57	2.57	2.57	5.5	12.5	14.0	1280	3840	4800	17.5	16.7	16.0	
	20+20+25+35+35+35	1.35	1.35	1.69	2.36	2.36	3.38	5.5	12.5	14.0	1280	3810	4800	17.3	16.6	15.9	
	20+20+25+35+35+50	1.28	1.28	1.60	2.24	2.24	3.85	5.5	12.5	14.0	1280	3800	4800	17.3	16.5	15.8	
	20+20+25+35+35+60	1.43	1.39	2.43	2.43	2.43	2.43	5.5	12.5	14.0	1280	3820	4800	17.4	16.6	15.9	
	20+20+35+35+35+35	1.28	1.28	2.24	2.24	2.24	3.21	5.5	12.5	14.0	1280	3800	4800	17.3	16.5	15.8	
20+25+25+25+25+25	1.72	2.16	2.16	2.16	2.16	2.16	5.5	12.5	14.0	1280	3870	4800	17.6	16.8	16.1		
20+25+25+25+25+35	1.61	2.02	2.02	2.02	2.02	2.82	5.5	12.5	14.0	1280	3860	4800	17.6	16.8	16.1		
20+25+25+25+25+50	1.47	1.84	1.84	1.84	1.84	3.68	5.5	12.5	14.0	1280	3840	4800	17.5	16.7	16.0		
20+25+25+25+25+60	1.39	1.74	1.74	1.74	1.74	4.17	5.5	12.5	14.0	1280	3820	4800	17.4	16.6	15.9		

COMBINATIONS

Indoor unit combination		Cooling capacity (kW)									Power consumption(W)			Standard current(A)			
		Room cooling capacity						Total capacity			Min.	Standard	Max.	220V	230V	240V	
		A	B	C	D	E	F	Min.	Standard	Max.							
Cooling operation	6 room	25+25+25+25+25+35	1.95	1.95	1.95	1.95	1.95	2.73	5.5	12.5	14.0	1280	3860	4800	17.6	16.8	16.1
		25+25+25+25+25+50	1.79	1.79	1.79	1.79	1.79	3.57	5.5	12.5	14.0	1280	3830	4800	17.4	16.7	16.0
		25+25+25+25+25+60	1.69	1.69	1.69	1.69	1.69	4.05	5.5	12.5	14.0	1280	3810	4800	17.3	16.6	15.9
		25+25+25+25+35+35	1.84	1.84	1.84	1.84	2.57	2.57	5.5	12.5	14.0	1280	3840	4800	17.5	16.7	16.0
		25+25+25+25+35+50	1.69	1.69	1.69	1.69	2.36	3.38	5.5	12.5	14.0	1280	3810	4800	17.3	16.6	15.9
		25+25+25+25+35+60	1.60	1.60	1.60	1.60	2.24	3.85	5.5	12.5	14.0	1280	3800	4800	17.3	16.5	15.8
		25+25+25+35+35+35	1.74	1.74	1.74	2.43	2.43	2.43	5.5	12.5	14.0	1280	3820	4800	17.4	16.6	15.9
		25+25+25+35+35+50	1.60	1.60	1.60	2.24	2.24	3.21	5.5	12.5	14.0	1280	3800	4800	17.3	16.5	15.8
25+25+35+35+35+35	1.64	1.64	2.30	2.30	2.30	2.30	5.5	12.5	14.0	1280	3800	4800	17.3	16.5	15.8		

SCM125ZM-S Table of Indoor unit combination with other indoor unit

Indoor unit combination		Heating capacity (kW)									Power consumption(W)			Standard current(A)			
		Room heating capacity						Total capacity			Min.	Standard	Max.	220V	230V	240V	
		A	B	C	D	E	F	Min.	Standard	Max.							
Heating operation	1 room	20	3.0	-	-	-	-	-	1.5	3.0	3.6	700	1220	1330	5.6	5.4	5.1
		25	3.4	-	-	-	-	-	1.5	3.4	4.1	700	1265	1540	5.8	5.6	5.3
		35	4.5	-	-	-	-	-	1.5	4.5	4.9	700	1650	1840	7.6	7.2	6.9
		50	5.8	-	-	-	-	-	1.5	5.8	6.4	700	2120	2410	9.7	9.3	8.9
		60	6.8	-	-	-	-	-	1.5	6.8	7.4	700	2500	2760	11.5	11.0	10.5
	2 room	71	8.0	-	-	-	-	-	1.5	8.0	8.1	700	3020	3090	13.9	13.3	12.7
		20+20	3.00	3.00	-	-	-	-	2.1	6.0	7.2	750	1540	1860	7.1	6.8	6.5
		20+25	2.84	3.56	-	-	-	-	2.1	6.4	7.7	750	1660	2210	7.6	7.3	7.0
		20+35	2.73	4.77	-	-	-	-	2.1	7.5	8.5	750	1990	2520	9.1	8.7	8.4
		20+50	2.51	6.29	-	-	-	-	2.1	8.8	10.0	750	2430	3220	11.2	10.7	10.2
		20+60	2.45	7.35	-	-	-	-	2.1	9.8	11.0	750	2840	3620	13.0	12.5	12.0
		20+71	2.42	8.58	-	-	-	-	2.1	11.0	11.6	750	2840	3620	13.0	12.5	12.0
		25+25	3.40	3.40	-	-	-	-	2.1	6.8	8.2	750	1770	2420	8.1	7.8	7.4
		25+35	3.29	4.61	-	-	-	-	2.1	7.9	9.0	750	2140	2820	9.8	9.4	9.0
		25+50	3.07	6.13	-	-	-	-	2.1	9.2	10.5	750	2630	3610	12.1	11.6	11.1
		25+60	3.00	7.20	-	-	-	-	2.1	10.2	11.5	750	3040	3790	14.0	13.4	12.8
		25+71	2.97	8.43	-	-	-	-	2.1	11.4	12.1	750	3440	4250	15.8	15.1	14.5
		35+35	4.50	4.50	-	-	-	-	2.1	9.0	9.8	750	2520	3210	11.6	11.1	10.6
		35+50	4.24	6.06	-	-	-	-	2.1	10.3	11.3	750	3040	3710	14.0	13.4	12.8
		35+60	4.16	7.14	-	-	-	-	2.1	11.3	12.3	750	3420	4320	15.7	15.0	14.4
		35+71	4.13	8.37	-	-	-	-	2.1	12.5	12.9	750	4030	4690	18.5	17.7	17.0
50+50	5.80	5.80	-	-	-	-	2.1	11.6	12.8	750	3660	4620	16.8	16.1	15.4		
50+60	5.73	6.87	-	-	-	-	2.1	12.6	13.8	750	4090	5230	18.8	18.0	17.2		
50+71	5.58	7.92	-	-	-	-	2.1	13.5	13.8	750	4540	5230	20.8	19.9	19.1		
60+60	6.75	6.75	-	-	-	-	2.1	13.5	13.8	750	4540	5230	20.8	19.9	19.1		
60+71	6.18	7.32	-	-	-	-	2.1	13.5	13.8	750	4540	5230	20.8	19.9	19.1		
71+71	6.75	6.75	-	-	-	-	2.1	13.5	13.8	750	4530	5230	20.8	19.9	19.1		
3 room	20+20+20	3.00	3.00	3.00	-	-	-	3.2	9.0	10.9	780	2270	3350	10.4	10.0	9.6	
	20+20+25	2.89	2.89	3.62	-	-	-	3.2	9.4	11.4	780	2400	3550	11.0	10.5	10.1	
	20+20+35	2.80	2.80	4.90	-	-	-	3.2	10.5	12.2	780	2760	3820	12.7	12.1	11.6	
	20+20+50	2.62	2.62	6.56	-	-	-	3.2	11.8	13.7	780	3270	4290	15.0	14.4	13.8	
	20+20+60	2.56	2.56	7.68	-	-	-	3.2	12.8	13.8	780	3690	4350	16.9	16.2	15.5	
	20+20+71	2.43	2.43	8.64	-	-	-	3.2	13.5	13.8	780	4140	4350	19.0	18.2	17.4	
	20+25+25	2.80	3.50	3.50	-	-	-	3.2	9.8	11.9	780	2560	3720	11.8	11.2	10.8	
	20+25+35	2.73	3.41	4.77	-	-	-	3.2	10.9	12.7	780	2970	3990	13.6	13.0	12.5	
	20+25+50	2.57	3.21	6.42	-	-	-	3.2	12.2	13.8	780	3480	4350	16.0	15.3	14.6	
	20+25+60	2.51	3.14	7.54	-	-	-	3.2	13.2	13.8	780	3990	4350	18.3	17.5	16.8	
	20+25+71	2.33	2.91	8.26	-	-	-	3.2	13.5	13.8	780	4140	4350	19.0	18.2	17.4	
	20+35+35	2.67	4.67	4.67	-	-	-	3.2	12.0	13.5	780	3460	4220	15.9	15.2	14.6	
	20+35+50	2.53	4.43	6.33	-	-	-	3.2	13.3	13.8	780	3980	4350	18.3	17.5	16.8	
	20+35+60	2.35	4.11	7.04	-	-	-	3.2	13.5	13.8	780	4130	4350	19.0	18.1	17.4	
	20+35+71	2.14	3.75	7.61	-	-	-	3.2	13.5	13.8	780	4130	4350	19.0	18.1	17.4	
	20+50+50	2.25	5.63	5.63	-	-	-	3.2	13.5	13.8	780	4130	4350	19.0	18.1	17.4	
	20+50+60	2.08	5.19	6.23	-	-	-	3.2	13.5	13.8	780	4130	4350	19.0	18.1	17.4	
	20+50+71	1.91	4.79	6.80	-	-	-	4.2	13.5	13.8	780	4130	4350	18.8	18.0	17.2	
	20+60+60	1.93	5.79	5.79	-	-	-	5.2	13.5	13.8	780	4130	4350	18.6	17.8	17.0	
	20+60+71	1.79	5.36	6.35	-	-	-	6.2	13.5	13.8	780	4120	4350	18.4	17.6	16.8	
	20+71+71	1.67	5.92	5.92	-	-	-	7.2	13.5	13.8	780	4120	4350	18.2	17.4	16.7	
	25+25+25	3.40	3.40	3.40	-	-	-	3.2	10.2	12.4	780	2760	3880	12.7	12.1	11.6	
	25+25+35	3.32	3.32	4.65	-	-	-	3.2	11.3	13.2	780	3170	4120	14.6	13.9	13.3	
	25+25+50	3.15	3.15	6.30	-	-	-	3.2	12.6	13.8	780	3690	4350	16.9	16.2	15.5	
	25+25+60	3.07	3.07	7.36	-	-	-	3.2	13.5	13.8	780	4130	4350	19.0	18.1	17.4	
	25+25+71	2.79	2.79	7.92	-	-	-	3.2	13.5	13.8	780	4130	4350	19.0	18.1	17.4	
	25+35+35	3.26	4.57	4.57	-	-	-	3.2	12.4	13.8	780	3780	4350	17.4	16.6	15.9	
	25+35+50	3.07	4.30	6.14	-	-	-	3.2	13.5	13.8	780	4140	4350	19.0	18.2	17.4	
	25+35+60	2.81	3.94	6.75	-	-	-	3.2	13.5	13.8	780	4140	4350	19.0	18.2	17.4	
	25+35+71	2.58	3.61	7.32	-	-	-	4.2	13.5	13.8	780	4130	4350	18.8	18.0	17.2	
25+50+50	2.70	5.40	5.40	-	-	-	3.2	13.5	13.8	780	4130	4350	19.0	18.1	17.4		
25+50+60	2.50	5.00	6.00	-	-	-	3.2	13.5	13.8	780	4130	4350	19.0	18.1	17.4		
25+50+71	2.31	4.62	6.57	-	-	-	3.2	13.5	13.8	780	4130	4350	19.0	18.1	17.4		
25+60+60	2.33	5.59	5.59	-	-	-	3.2	13.5	13.8	780	4130	4350	19.0	18.1	17.4		



MULTI-SPLIT SYSTEM

Indoor unit combination		Heating capacity (kW)									Power consumption(W)			Standard current(A)				
		Room heating capacity						Total capacity			Min.	Standard	Max.	220V	230V	240V		
		A	B	C	D	E	F	Min.	Standard	Max.								
3 room	25+60+71	2.16	5.19	6.14	-	-	-	3.2	13.5	13.8	780	4120	4350	18.9	18.1	17.3		
	25+71+71	2.02	5.74	5.74	-	-	-	3.2	13.5	13.8	780	4120	4350	18.9	18.1	17.3		
	35+35+35	4.50	4.50	4.50	-	-	-	3.2	13.5	13.8	780	4140	4350	19.0	18.2	17.4		
	35+35+50	3.94	3.94	5.63	-	-	-	3.2	13.5	13.8	780	4140	4350	19.0	18.2	17.4		
	35+35+60	3.63	3.63	6.23	-	-	-	3.2	13.5	13.8	780	4130	4350	19.0	18.1	17.4		
	35+35+71	3.35	3.35	6.80	-	-	-	3.2	13.5	13.8	780	4130	4350	19.0	18.1	17.4		
	35+50+50	3.50	5.00	5.00	-	-	-	3.2	13.5	13.8	780	4130	4350	19.0	18.1	17.4		
	35+50+60	3.26	4.66	5.59	-	-	-	3.2	13.5	13.8	780	4130	4350	19.0	18.1	17.4		
	35+50+71	3.03	4.33	6.14	-	-	-	3.2	13.5	13.8	780	4120	4350	18.9	18.1	17.3		
	35+60+60	3.05	5.23	5.23	-	-	-	3.2	13.5	13.8	780	4120	4350	18.9	18.1	17.3		
	35+60+71	2.85	4.88	5.77	-	-	-	3.2	13.5	13.8	780	4120	4350	18.9	18.1	17.3		
	35+71+71	2.67	5.42	5.42	-	-	-	3.2	13.5	13.8	780	4120	4350	18.9	18.1	17.3		
	50+50+50	4.50	4.50	4.50	-	-	-	3.2	13.5	13.8	780	4120	4350	18.9	18.1	17.3		
	50+50+60	4.22	4.22	5.06	-	-	-	3.2	13.5	13.8	780	4120	4350	18.9	18.1	17.3		
	50+50+71	3.95	3.95	5.61	-	-	-	3.2	13.5	13.8	780	4120	4350	18.9	18.1	17.3		
	50+60+60	3.97	4.76	4.76	-	-	-	3.2	13.5	13.8	780	4120	4350	18.9	18.1	17.3		
	50+60+71	3.73	4.48	5.30	-	-	-	3.2	13.5	13.8	780	4110	4350	18.9	18.1	17.3		
	60+60+60	4.50	4.50	4.50	-	-	-	3.2	13.5	13.8	780	4110	4350	18.9	18.1	17.3		
	60+60+71	4.24	4.24	5.02	-	-	-	3.2	13.5	13.8	780	4110	4350	18.9	18.1	17.3		
	Heating operation	4 room	20+20+20+20	3.00	3.00	3.00	3.00	-	-	-	3.6	12.0	13.8	950	3270	3920	14.9	14.2
20+20+20+25			2.92	2.92	2.92	3.65	-	-	3.6	12.4	13.8	950	3460	3920	15.7	15.1	14.4	
20+20+20+35			2.84	2.84	2.84	4.97	-	-	3.6	13.5	13.8	950	3770	3920	17.2	16.4	15.7	
20+20+20+50			2.45	2.45	2.45	6.14	-	-	3.6	13.5	13.8	950	3760	3920	17.1	16.4	15.7	
20+20+20+60			2.25	2.25	2.25	6.75	-	-	3.6	13.5	13.8	950	3760	3920	17.1	16.4	15.7	
20+20+20+71			2.06	2.06	2.06	7.32	-	-	3.6	13.5	13.8	950	3750	3920	16.9	16.2	15.5	
20+20+25+25			2.84	2.84	3.56	3.56	-	-	3.6	12.8	13.8	950	3510	3920	16.0	15.3	14.6	
20+20+25+35			2.70	2.70	3.38	4.73	-	-	3.6	13.5	13.8	950	3770	3920	17.2	16.4	15.7	
20+20+25+50			2.35	2.35	2.93	5.87	-	-	3.6	13.5	13.8	950	3760	3920	17.1	16.4	15.7	
20+20+25+60			2.16	2.16	2.70	6.48	-	-	3.6	13.5	13.8	950	3750	3920	17.1	16.3	15.6	
20+20+25+71			1.99	1.99	2.48	7.05	-	-	3.6	13.5	13.8	950	3750	3920	17.1	16.3	15.6	
20+20+35+35			2.45	2.45	4.30	4.30	-	-	3.6	13.5	13.8	950	3760	3920	17.1	16.4	15.7	
20+20+35+50			2.16	2.16	3.78	5.40	-	-	3.6	13.5	13.8	950	3750	3920	17.1	16.3	15.6	
20+20+35+60			2.00	2.00	3.50	6.00	-	-	3.6	13.5	13.8	950	3750	3920	17.1	16.3	15.6	
20+20+35+71			1.85	1.85	3.24	6.57	-	-	3.6	13.5	13.8	950	3740	3920	17.0	16.3	15.6	
20+20+50+50			1.93	1.93	4.82	4.82	-	-	3.6	13.5	13.8	950	3740	3920	17.0	16.3	15.6	
20+20+50+60			1.80	1.80	4.50	5.40	-	-	3.6	13.5	13.8	950	3740	3920	17.0	16.3	15.6	
20+20+50+71			1.68	1.68	4.19	5.95	-	-	3.6	13.5	13.8	950	3740	3920	17.0	16.3	15.6	
20+20+60+60			1.69	1.69	5.06	5.06	-	-	3.6	13.5	13.8	950	3740	3920	17.0	16.3	15.6	
20+20+60+71			1.58	1.58	4.74	5.61	-	-	3.6	13.5	13.8	950	3730	3920	17.0	16.2	15.6	
20+20+71+71		1.48	1.48	5.27	5.27	-	-	3.6	13.5	13.8	950	3730	3920	17.0	16.2	15.6		
20+25+25+25		2.78	3.47	3.47	3.47	-	-	3.6	13.2	13.8	950	3620	3920	16.5	15.8	15.1		
20+25+25+35		2.57	3.21	3.21	4.50	-	-	3.6	13.5	13.8	950	3770	3920	17.2	16.4	15.7		
20+25+25+50		2.25	2.81	2.81	5.63	-	-	3.6	13.5	13.8	950	3760	3920	17.1	16.4	15.7		
20+25+25+60		2.08	2.60	2.60	6.23	-	-	3.6	13.5	13.8	950	3750	3920	17.1	16.3	15.6		
20+25+25+71		1.91	2.39	2.39	6.80	-	-	3.6	13.5	13.8	950	3740	3920	17.0	16.3	15.6		
20+25+35+35		2.35	2.93	4.11	4.11	-	-	3.6	13.5	13.8	950	3760	3920	17.1	16.4	15.7		
20+25+35+50		2.08	2.60	3.63	5.19	-	-	3.6	13.5	13.8	950	3750	3920	17.1	16.3	15.6		
20+25+35+60		1.93	2.41	3.38	5.79	-	-	3.6	13.5	13.8	950	3740	3920	17.0	16.3	15.6		
20+25+35+71		1.79	2.24	3.13	6.35	-	-	3.6	13.5	13.8	950	3740	3920	17.0	16.3	15.6		
20+25+50+50		1.86	2.33	4.66	4.66	-	-	3.6	13.5	13.8	950	3740	3920	17.0	16.3	15.6		
20+25+50+60		1.74	2.18	4.35	5.23	-	-	3.6	13.5	13.8	950	3740	3920	17.0	16.3	15.6		
20+25+50+71		1.63	2.03	4.07	5.77	-	-	3.6	13.5	13.8	950	3730	3920	17.0	16.2	15.6		
20+25+60+60		1.64	2.05	4.91	4.91	-	-	3.6	13.5	13.8	950	3730	3920	17.0	16.2	15.6		
20+25+60+71		1.53	1.92	4.60	5.45	-	-	3.6	13.5	13.8	950	3730	3920	17.0	16.2	15.6		
20+25+71+71		1.44	1.80	5.13	5.13	-	-	3.6	13.5	13.8	950	3720	3920	16.9	16.2	15.5		
20+35+35+35		2.16	3.78	3.78	3.78	-	-	3.6	13.5	13.8	950	3750	3920	17.1	16.3	15.6		
20+35+35+50		1.93	3.38	3.38	4.82	-	-	3.6	13.5	13.8	950	3740	3920	17.0	16.3	15.6		
20+35+35+60		1.80	3.15	3.15	5.40	-	-	3.6	13.5	13.8	950	3740	3920	17.0	16.3	15.6		
20+35+35+71		1.68	2.93	2.93	5.95	-	-	3.6	13.5	13.8	950	3740	3920	17.0	16.3	15.6		
20+35+50+50	1.74	3.05	4.35	4.35	-	-	3.6	13.5	13.8	950	3740	3920	17.0	16.3	15.6			
20+35+50+60	1.64	2.86	4.09	4.91	-	-	3.6	13.5	13.8	950	3730	3920	17.0	16.2	15.6			
20+35+50+71	1.53	2.68	3.84	5.45	-	-	3.6	13.5	13.8	950	3730	3920	17.0	16.2	15.6			
20+35+60+60	1.54	2.70	4.63	4.63	-	-	3.6	13.5	13.8	950	3730	3920	17.0	16.2	15.6			
20+35+60+71	1.45	2.54	4.35	5.15	-	-	3.6	13.5	13.8	950	3720	3920	16.9	16.2	15.5			
20+50+50+50	1.59	3.97	3.97	3.97	-	-	3.6	13.5	13.8	950	3730	3920	17.0	16.2	15.6			
20+50+50+60	1.50	3.75	3.75	4.50	-	-	3.6	13.5	13.8	950	3730	3920	17.0	16.2	15.6			
20+50+50+71	1.41	3.53	3.53	5.02	-	-	3.6	13.5	13.8	950	3720	3920	16.9	16.2	15.5			
20+50+60+60	1.42	3.55	4.26	4.26	-	-	3.6	13.5	13.8	950	3720	3920	16.9	16.2	15.5			
25+25+25+25	3.38	3.38	3.38	3.38	-	-	3.6	13.5	13.8	950	3770	3920	17.2	16.4	15.7			
25+25+25+35	3.07	3.07	3.07	4.30	-	-	3.6	13.5	13.8	950	3760	3920	17.1	16.4	15.7			
25+25+25+50	2.70	2.70	2.70	5.40	-	-	3.6	13.5	13.8	950	3750	3920	17.1	16.3	15.6			
25+25+25+60	2.50	2.50	2.50	6.00	-	-	3.6	13.5	13.8	950	3750	3920	17.1	16.3	15.6			
25+25+25+71	2.31	2.31	2.31	6.57	-	-	3.6	13.5	13.8	950	3740	3920	17.0	16.3	15.6			
25+25+35+35	2.81	2.81	3.94	3.94	-	-	3.6	13.5	13.8	950	3760	3920	17.1	16.				

COMBINATIONS

Indoor unit combination		Heating capacity (kW)									Power consumption(W)			Standard current(A)			
		Room heating capacity						Total capacity			Min.	Standard	Max.	220V	230V	240V	
		A	B	C	D	E	F	Min.	Standard	Max.							
4 room	25+25+50+50	2.25	2.25	4.50	4.50	-	-	3.6	13.5	13.8	950	3740	3920	17.0	16.3	15.6	
	25+25+50+60	2.11	2.11	4.22	5.06	-	-	3.6	13.5	13.8	950	3740	3920	17.0	16.3	15.6	
	25+25+50+71	1.97	1.97	3.95	5.61	-	-	3.6	13.5	13.8	950	3730	3920	17.0	16.2	15.6	
	25+25+60+60	1.99	1.99	4.76	4.76	-	-	3.6	13.5	13.8	950	3730	3920	17.0	16.2	15.6	
	25+25+60+71	1.86	1.86	4.48	5.30	-	-	3.6	13.5	13.8	950	3730	3920	17.0	16.2	15.6	
	25+25+71+71	1.76	1.76	4.99	4.99	-	-	3.6	13.5	13.8	950	3720	3920	16.9	16.2	15.5	
	25+35+35+35	2.60	3.63	3.63	3.63	-	-	3.6	13.5	13.8	950	3750	3920	17.1	16.3	15.6	
	25+35+35+50	2.33	3.26	3.26	4.66	-	-	3.6	13.5	13.8	950	3740	3920	17.0	16.3	15.6	
	25+35+35+60	2.18	3.05	3.05	5.23	-	-	3.6	13.5	13.8	950	3740	3920	17.0	16.3	15.6	
	25+35+35+71	2.03	2.85	2.85	5.77	-	-	3.6	13.5	13.8	950	3730	3920	17.0	16.2	15.6	
	25+35+50+50	2.11	2.95	4.22	4.22	-	-	3.6	13.5	13.8	950	3740	3920	17.0	16.3	15.6	
	25+35+50+60	1.99	2.78	3.97	4.76	-	-	3.6	13.5	13.8	950	3730	3920	17.0	16.2	15.6	
	25+35+50+71	1.86	2.61	3.73	5.30	-	-	3.6	13.5	13.8	950	3730	3920	17.0	16.2	15.6	
	25+35+60+60	1.88	2.63	4.50	4.50	-	-	3.6	13.5	13.8	950	3730	3920	17.0	16.2	15.6	
	25+35+60+71	1.77	2.47	4.24	5.02	-	-	3.6	13.5	13.8	950	3720	3920	16.9	16.2	15.5	
	25+50+50+50	1.93	3.86	3.86	3.86	-	-	3.6	13.5	13.8	950	3730	3920	17.0	16.2	15.6	
	25+50+50+60	1.82	3.65	3.65	4.38	-	-	3.6	13.5	13.8	950	3720	3920	16.9	16.2	15.5	
	25+50+60+60	1.73	3.46	4.15	4.15	-	-	3.6	13.5	13.8	950	3720	3920	16.9	16.2	15.5	
	35+35+35+35	3.38	3.38	3.38	3.38	-	-	3.6	13.5	13.8	950	3740	3920	17.0	16.3	15.6	
	35+35+35+50	3.05	3.05	3.05	4.35	-	-	3.6	13.5	13.8	950	3740	3920	17.0	16.3	15.6	
	35+35+35+60	2.86	2.86	2.86	4.91	-	-	3.6	13.5	13.8	950	3730	3920	17.0	16.2	15.6	
	35+35+35+71	2.68	2.68	2.68	5.45	-	-	3.6	13.5	13.8	950	3730	3920	17.0	16.2	15.6	
	35+35+50+50	2.78	2.78	3.97	3.97	-	-	3.6	13.5	13.8	950	3730	3920	17.0	16.2	15.6	
	35+35+50+60	2.63	2.63	3.75	4.50	-	-	3.6	13.5	13.8	950	3730	3920	17.0	16.2	15.6	
	35+35+50+71	2.47	2.47	3.53	5.02	-	-	3.6	13.5	13.8	950	3720	3920	16.9	16.2	15.5	
	35+35+60+60	2.49	2.49	4.26	4.26	-	-	3.6	13.5	13.8	950	3720	3920	16.9	16.2	15.5	
	35+50+50+50	2.55	3.65	3.65	3.65	-	-	3.6	13.5	13.8	950	3720	3920	16.9	16.2	15.5	
	35+50+50+60	2.42	3.46	3.46	4.15	-	-	3.6	13.5	13.8	950	3720	3920	16.9	16.2	15.5	
	5 room	20+20+20+20+20	2.70	2.70	2.70	2.70	2.70	-	4.0	13.5	13.8	1050	3450	3470	15.7	15.0	14.4
		20+20+20+20+25	2.57	2.57	2.57	2.57	3.21	-	4.0	13.5	13.8	1050	3450	3470	15.7	15.0	14.4
		20+20+20+20+35	2.35	2.35	2.35	2.35	4.11	-	4.0	13.5	13.8	1050	3440	3470	15.7	15.0	14.3
		20+20+20+20+50	2.08	2.08	2.08	2.08	5.19	-	4.0	13.5	13.8	1050	3430	3470	15.6	14.9	14.3
		20+20+20+20+60	1.93	1.93	1.93	1.93	5.79	-	4.0	13.5	13.8	1050	3430	3470	15.6	14.9	14.3
		20+20+20+20+71	1.79	1.79	1.79	1.79	6.35	-	4.0	13.5	13.8	1050	3420	3470	15.6	14.9	14.3
		20+20+20+25+25	2.45	2.45	2.45	3.07	3.07	-	4.0	13.5	13.8	1050	3450	3470	15.7	15.0	14.4
20+20+20+25+35		2.25	2.25	2.25	2.81	3.94	-	4.0	13.5	13.8	1050	3440	3470	15.7	15.0	14.3	
20+20+20+25+50		2.00	2.00	2.00	2.50	5.00	-	4.0	13.5	13.8	1050	3430	3470	15.6	14.9	14.3	
20+20+20+25+60		1.86	1.86	1.86	2.33	5.59	-	4.0	13.5	13.8	1050	3420	3470	15.6	14.9	14.3	
20+20+20+25+71		1.73	1.73	1.73	2.16	6.14	-	4.0	13.5	13.8	1050	3420	3470	15.6	14.9	14.3	
20+20+20+35+35		2.08	2.08	2.08	3.63	3.63	-	4.0	13.5	13.8	1050	3430	3470	15.6	14.9	14.3	
20+20+20+35+50		1.86	1.86	1.86	3.26	4.66	-	4.0	13.5	13.8	1050	3420	3470	15.6	14.9	14.3	
20+20+20+35+60		1.74	1.74	1.74	3.05	5.23	-	4.0	13.5	13.8	1050	3420	3470	15.6	14.9	14.3	
20+20+20+35+71		1.63	1.63	1.63	2.85	5.77	-	4.0	13.5	13.8	1050	3410	3470	15.5	14.8	14.2	
20+20+20+50+50		1.69	1.69	1.69	4.22	4.22	-	4.0	13.5	13.8	1050	3410	3470	15.5	14.8	14.2	
20+20+20+50+60		1.59	1.59	1.59	3.97	4.76	-	4.0	13.5	13.8	1050	3410	3470	15.5	14.8	14.2	
20+20+20+60+60		1.50	1.50	1.50	4.50	4.50	-	4.0	13.5	13.8	1050	3400	3470	15.5	14.8	14.2	
20+20+20+60+71		1.41	1.41	1.41	4.24	5.02	-	4.0	13.5	13.8	1050	3390	3470	15.4	14.8	14.1	
20+20+25+25+25		2.35	2.35	2.93	2.93	2.93	-	4.0	13.5	13.8	1050	3440	3470	15.7	15.0	14.3	
20+20+25+25+35		2.16	2.16	2.70	2.70	3.78	-	4.0	13.5	13.8	1050	3440	3470	15.7	15.0	14.3	
20+20+25+25+50		1.93	1.93	2.41	2.41	4.82	-	4.0	13.5	13.8	1050	3430	3470	15.6	14.9	14.3	
20+20+25+25+60		1.80	1.80	2.25	2.25	5.40	-	4.0	13.5	13.8	1050	3420	3470	15.6	14.9	14.3	
20+20+25+25+71		1.68	1.68	2.10	2.10	5.95	-	4.0	13.5	13.8	1050	3410	3470	15.5	14.8	14.2	
20+20+25+35+35		2.00	2.00	2.50	3.50	3.50	-	4.0	13.5	13.8	1050	3430	3470	15.6	14.9	14.3	
20+20+25+35+50		1.80	1.80	2.25	3.15	4.50	-	4.0	13.5	13.8	1050	3420	3470	15.6	14.9	14.3	
20+20+25+35+60		1.69	1.69	2.11	2.95	5.06	-	4.0	13.5	13.8	1050	3410	3470	15.5	14.8	14.2	
20+20+25+35+71		1.58	1.58	1.97	2.76	5.61	-	4.0	13.5	13.8	1050	3410	3470	15.5	14.8	14.2	
20+20+25+50+50		1.64	1.64	2.05	4.09	4.09	-	4.0	13.5	13.8	1050	3410	3470	15.5	14.8	14.2	
20+20+25+50+60		1.54	1.54	1.93	3.86	4.63	-	4.0	13.5	13.8	1050	3410	3470	15.5	14.8	14.2	
20+20+25+50+71		1.45	1.45	1.81	3.63	5.15	-	4.0	13.5	13.8	1050	3400	3470	15.5	14.8	14.2	
20+20+25+60+60		1.46	1.46	1.82	4.38	4.38	-	4.0	13.5	13.8	1050	3400	3470	15.5	14.8	14.2	
20+20+35+35+35		1.86	1.86	3.26	3.26	3.26	-	4.0	13.5	13.8	1050	3420	3470	15.6	14.9	14.3	
20+20+35+35+50		1.69	1.69	2.95	2.95	4.22	-	4.0	13.5	13.8	1050	3410	3470	15.5	14.8	14.2	
20+20+35+35+60		1.59	1.59	2.78	2.78	4.76	-	4.0	13.5	13.8	1050	3410	3470	15.5	14.8	14.2	
20+20+35+35+71	1.49	1.49	2.61	2.61	5.30	-	4.0	13.5	13.8	1050	3400	3470	15.5	14.8	14.2		
20+20+35+50+50	1.54	1.54	2.70	3.86	3.86	-	4.0	13.5	13.8	1050	3410	3470	15.5	14.8	14.2		
20+20+35+50+60	1.46	1.46	2.55	3.65	4.38	-	4.0	13.5	13.8	1050	3400	3470	15.5	14.8	14.2		
20+20+35+60+60	1.38	1.38	2.42	4.15	4.15	-	4.0	13.5	13.8	1050	3390	3470	15.4	14.8	14.1		
20+20+50+50+50	1.42	1.42	3.55	3.55	3.55	-	4.0	13.5	13.8	1050	3390	3470	15.4	14.8	14.1		
20+25+25+25+25	2.25	2.81	2.81	2.81	2.81	-	4.0	13.5	13.8	1050	3440	3470	15.7	15.0	14.3		
20+25+25+25+35	2.08	2.60	2.60	2.60	3.63	-	4.0	13.5	13.8	1050	3430	3470	15.6	14.9	14.3		
20+25+25+25+50	1.86	2.33	2.33	2.33	4.66	-	4.0	13.5	13.8	1050	3420	3470	15.6	14.9	14.3		
20+25+25+25+60	1.74	2.18	2.18														



MULTI-SPLIT SYSTEM

Indoor unit combination		Heating capacity (kW)										Power consumption(W)			Standard current(A)		
		Room heating capacity						Total capacity				Min.	Standard	Max.	220V	230V	240V
		A	B	C	D	E	F	Min.	Standard	Max.							
Heating operation	5 room	20+25+25+50+50	1.59	1.99	1.99	3.97	3.97	-	4.0	13.5	13.8	1050	3410	3470	15.5	14.8	14.2
		20+25+25+50+60	1.50	1.88	1.88	3.75	4.50	-	4.0	13.5	13.8	1050	3400	3470	15.5	14.8	14.2
		20+25+25+50+71	1.41	1.77	1.77	3.53	5.02	-	4.0	13.5	13.8	1050	3390	3470	15.4	14.8	14.1
		20+25+25+60+60	1.42	1.78	1.78	4.26	4.26	-	4.0	13.5	13.8	1050	3390	3470	15.4	14.8	14.1
		20+25+35+35+35	1.80	2.25	3.15	3.15	3.15	-	4.0	13.5	13.8	1050	3420	3470	15.6	14.9	14.3
		20+25+35+35+50	1.64	2.05	2.86	2.86	4.09	-	4.0	13.5	13.8	1050	3410	3470	15.5	14.8	14.2
		20+25+35+35+60	1.54	1.93	2.70	2.70	4.63	-	4.0	13.5	13.8	1050	3410	3470	15.5	14.8	14.2
		20+25+35+35+71	1.45	1.81	2.54	2.54	5.15	-	4.0	13.5	13.8	1050	3400	3470	15.5	14.8	14.2
		20+25+35+50+50	1.50	1.88	2.63	3.75	3.75	-	4.0	13.5	13.8	1050	3400	3470	15.5	14.8	14.2
		20+25+35+50+60	1.42	1.78	2.49	3.55	4.26	-	4.0	13.5	13.8	1050	3390	3470	15.4	14.8	14.1
		20+25+50+50+50	1.38	1.73	3.46	3.46	3.46	-	4.0	13.5	13.8	1050	3390	3470	15.4	14.8	14.1
		20+35+35+35+35	1.69	2.95	2.95	2.95	2.95	-	4.0	13.5	13.8	1050	3410	3470	15.5	14.8	14.2
		20+35+35+35+50	1.54	2.70	2.70	2.70	3.86	-	4.0	13.5	13.8	1050	3410	3470	15.5	14.8	14.2
		20+35+35+35+60	1.46	2.55	2.55	2.55	4.38	-	4.0	13.5	13.8	1050	3400	3470	15.5	14.8	14.2
		20+35+35+50+50	1.42	2.49	2.49	3.55	3.55	-	4.0	13.5	13.8	1050	3390	3470	15.4	14.8	14.1
		25+25+25+25+25	2.70	2.70	2.70	2.70	2.70	-	4.0	13.5	13.8	1050	3440	3470	15.7	15.0	14.3
		25+25+25+25+35	2.50	2.50	2.50	2.50	3.50	-	4.0	13.5	13.8	1050	3430	3470	15.6	14.9	14.3
		25+25+25+25+50	2.25	2.25	2.25	2.25	4.50	-	4.0	13.5	13.8	1050	3420	3470	15.6	14.9	14.3
		25+25+25+25+60	2.11	2.11	2.11	2.11	5.06	-	4.0	13.5	13.8	1050	3410	3470	15.5	14.8	14.2
		25+25+25+25+71	1.97	1.97	1.97	1.97	5.61	-	4.0	13.5	13.8	1050	3410	3470	15.5	14.8	14.2
		25+25+25+35+35	2.33	2.33	2.33	3.26	3.26	-	4.0	13.5	13.8	1050	3420	3470	15.6	14.9	14.3
		25+25+25+35+50	2.11	2.11	2.11	2.95	4.22	-	4.0	13.5	13.8	1050	3410	3470	15.5	14.8	14.2
		25+25+25+35+60	1.99	1.99	1.99	2.78	4.76	-	4.0	13.5	13.8	1050	3410	3470	15.5	14.8	14.2
		25+25+25+35+71	1.86	1.86	1.86	2.61	5.30	-	4.0	13.5	13.8	1050	3400	3470	15.5	14.8	14.2
		25+25+25+50+50	1.93	1.93	1.93	3.86	3.86	-	4.0	13.5	13.8	1050	3410	3470	15.5	14.8	14.2
		25+25+25+50+60	1.82	1.82	1.82	3.65	4.38	-	4.0	13.5	13.8	1050	3400	3470	15.5	14.8	14.2
		25+25+25+60+60	1.73	1.73	1.73	4.15	4.15	-	4.0	13.5	13.8	1050	3390	3470	15.4	14.8	14.1
		25+25+35+35+35	2.18	2.18	3.05	3.05	3.05	-	4.0	13.5	13.8	1050	3420	3470	15.6	14.9	14.3
		25+25+35+35+50	1.99	1.99	2.78	2.78	3.97	-	4.0	13.5	13.8	1050	3410	3470	15.5	14.8	14.2
		25+25+35+35+60	1.88	1.88	2.63	2.63	4.50	-	4.0	13.5	13.8	1050	3400	3470	15.5	14.8	14.2
		25+25+35+35+71	1.77	1.77	2.47	2.47	5.02	-	4.0	13.5	13.8	1050	3390	3470	15.4	14.8	14.1
		25+25+35+50+50	1.82	1.82	2.55	3.65	3.65	-	4.0	13.5	13.8	1050	3400	3470	15.5	14.8	14.2
		25+25+35+50+60	1.73	1.73	2.42	3.46	4.15	-	4.0	13.5	13.8	1050	3390	3470	15.4	14.8	14.1
		25+35+35+35+35	2.05	2.86	2.86	2.86	2.86	-	4.0	13.5	13.8	1050	3410	3470	15.5	14.8	14.2
		25+35+35+35+50	1.88	2.63	2.63	2.63	3.75	-	4.0	13.5	13.8	1050	3400	3470	15.5	14.8	14.2
25+35+35+35+60	1.78	2.49	2.49	2.49	4.26	-	4.0	13.5	13.8	1050	3390	3470	15.4	14.8	14.1		
25+35+35+50+50	1.73	2.42	2.42	3.46	3.46	-	4.0	13.5	13.8	1050	3390	3470	15.4	14.8	14.1		
35+35+35+35+35	2.70	2.70	2.70	2.70	2.70	-	4.0	13.5	13.8	1050	3410	3470	15.5	14.8	14.2		
35+35+35+35+50	2.49	2.49	2.49	2.49	3.55	-	4.0	13.5	13.8	1050	3390	3470	15.4	14.8	14.1		
20+20+20+20+20+20	2.25	2.25	2.25	2.25	2.25	2.25	4.5	13.5	13.8	1150	3330	3420	15.2	14.5	13.9		
20+20+20+20+20+25	2.16	2.16	2.16	2.16	2.16	2.70	4.5	13.5	13.8	1150	3330	3420	15.2	14.5	13.9		
20+20+20+20+20+35	2.00	2.00	2.00	2.00	2.00	3.50	4.5	13.5	13.8	1150	3330	3420	15.2	14.5	13.9		
20+20+20+20+20+50	1.80	1.80	1.80	1.80	1.80	4.50	4.5	13.5	13.8	1150	3320	3420	15.1	14.4	13.8		
20+20+20+20+20+60	1.69	1.69	1.69	1.69	1.69	5.06	4.5	13.5	13.8	1150	3320	3420	15.1	14.4	13.8		
20+20+20+20+20+71	1.58	1.58	1.58	1.58	1.58	5.61	4.5	13.5	13.8	1150	3310	3420	15.1	14.4	13.8		
20+20+20+20+25+25	2.08	2.08	2.08	2.08	2.60	2.60	4.5	13.5	13.8	1150	3330	3420	15.2	14.5	13.9		
20+20+20+20+25+35	1.93	1.93	1.93	1.93	2.41	3.38	4.5	13.5	13.8	1150	3320	3420	15.1	14.4	13.8		
20+20+20+20+25+50	1.74	1.74	1.74	1.74	2.18	4.35	4.5	13.5	13.8	1150	3320	3420	15.1	14.4	13.8		
20+20+20+20+25+60	1.64	1.64	1.64	1.64	2.05	4.91	4.5	13.5	13.8	1150	3320	3420	15.1	14.4	13.8		
20+20+20+20+25+71	1.53	1.53	1.53	1.53	1.92	5.45	4.5	13.5	13.8	1150	3310	3420	15.1	14.4	13.8		
20+20+20+20+35+35	1.80	1.80	1.80	1.80	3.15	3.15	4.5	13.5	13.8	1150	3320	3420	15.1	14.4	13.8		
20+20+20+20+35+50	1.64	1.64	1.64	1.64	2.86	4.09	4.5	13.5	13.8	1150	3320	3420	15.1	14.4	13.8		
20+20+20+20+35+60	1.54	1.54	1.54	1.54	2.70	4.63	4.5	13.5	13.8	1150	3310	3420	15.1	14.4	13.8		
20+20+20+20+35+71	1.45	1.45	1.45	1.45	2.54	5.15	4.5	13.5	13.8	1150	3310	3420	15.1	14.4	13.8		
20+20+20+20+50+50	1.50	1.50	1.50	1.50	3.75	3.75	4.5	13.5	13.8	1150	3310	3420	15.1	14.4	13.8		
20+20+20+20+50+60	1.42	1.42	1.42	1.42	3.55	4.26	4.5	13.5	13.8	1150	3310	3420	15.1	14.4	13.8		
20+20+20+25+25+25	2.00	2.00	2.00	2.50	2.50	2.50	4.5	13.5	13.8	1150	3330	3420	15.2	14.5	13.9		
20+20+20+25+25+35	1.86	1.86	1.86	2.33	2.33	3.26	4.5	13.5	13.8	1150	3320	3420	15.1	14.4	13.8		
20+20+20+25+25+50	1.69	1.69	1.69	2.11	2.11	4.22	4.5	13.5	13.8	1150	3320	3420	15.1	14.4	13.8		
20+20+20+25+25+60	1.59	1.59	1.59	1.99	1.99	4.76	4.5	13.5	13.8	1150	3310	3420	15.1	14.4	13.8		
20+20+20+25+25+71	1.49	1.49	1.49	1.86	1.86	5.30	4.5	13.5	13.8	1150	3310	3420	15.1	14.4	13.8		
20+20+20+25+35+35	1.74	1.74	1.74	2.18	3.05	3.05	4.5	13.5	13.8	1150	3320	3420	15.1	14.4	13.8		
20+20+20+25+35+50	1.59	1.59	1.59	1.99	2.78	3.97	4.5	13.5	13.8	1150	3310	3420	15.1	14.4	13.8		
20+20+20+25+35+60	1.50	1.50	1.50	1.88	2.63	4.50	4.5	13.5	13.8	1150	3310	3420	15.1	14.4	13.8		
20+20+20+25+50+50	1.46	1.46	1.46	1.82	3.65	3.65	4.5	13.5	13.8	1150	3310	3420	15.1	14.4	13.8		
20+20+20+25+50+60	1.38	1.38	1.38	1.73	3.46	4.15	4.5	13.5	13.8	1150	3310	3420	15.1	14.4	13.8		
20+20+20+35+35+35	1.64	1.64	1.64	2.86	2.86	2.86	4.5	13.5	13.8	1150	3320	3420	15.1	14.4	13.8		
20+20+20+35+35+50	1.50	1.50	1.50	2.63	2.63	3.75	4.5	13.5	13.8	1150	3310	3420	15.1	14.4	13.8		
20+20+20+35+35+60	1.42	1.42	1.42	2.49	2.49	4.26	4.5	13.5	13.8	1150	3310	3420	15.1	14.4	13.8		
20+20+20+35+50+50	1.38	1.38	1.38	2.42	3.46	3.46	4.5	13.5	13.8	1150	3310	3420	15.1	14.4	13.8		
20+20+25+25+25+25	1.93	1.93	2.41	2.41	2.41	2.41	4.5	13.5	13.8	1150	3320	3420	15.1	14.4	13.8		
20+20+25+25+25+35	1.80	1.80	2.25	2.25	2.25	3.15	4.5	13.5	13.8	1150	3320	3420	15.1	14.4	13.8		
20+20+25+25+25+50	1.64	1.64	2.05	2.05	2.05	4.09	4.5	13.5	13.8	1150	3320	3420	15.1	14.4	13.8		
20+20+25+25+25+60	1.54	1.54	1.93	1.93	1.93	4.63	4.5	13.5	13.8	1150	3310	3420	15.1	14.4	13.8		
20+20+25+25+25+71	1.45	1.45	1.81	1.81	1.81	5.15	4.5	13.5	13.8	1150	3310	3420	15.1				

COMBINATIONS

Indoor unit combination		Heating capacity (kW)									Power consumption(W)			Standard current(A)			
		Room heating capacity						Total capacity			Min.	Standard	Max.	220V	230V	240V	
		A	B	C	D	E	F	Min.	Standard	Max.							
Heating operation	6 room	20+20+25+25+35+60	1.46	1.46	1.82	1.82	2.55	4.38	4.5	13.5	13.8	1150	3310	3420	15.1	14.4	13.8
		20+20+25+25+50+50	1.42	1.42	1.78	1.78	3.55	3.55	4.5	13.5	13.8	1150	3310	3420	15.1	14.4	13.8
		20+20+25+35+35+35	1.59	1.59	1.99	2.78	2.78	2.78	4.5	13.5	13.8	1150	3310	3420	15.1	14.4	13.8
		20+20+25+35+35+50	1.46	1.46	1.82	2.55	2.55	3.65	4.5	13.5	13.8	1150	3310	3420	15.1	14.4	13.8
		20+20+25+35+35+60	1.38	1.38	1.73	2.42	2.42	4.15	4.5	13.5	13.8	1150	3310	3420	15.1	14.4	13.8
		20+20+35+35+35+35	1.50	1.50	2.63	2.63	2.63	2.63	4.5	13.5	13.8	1150	3310	3420	15.1	14.4	13.8
		20+20+35+35+35+50	1.38	1.38	2.42	2.42	2.42	3.46	4.5	13.5	13.8	1150	3310	3420	15.1	14.4	13.8
		20+25+25+25+25+25	1.86	2.33	2.33	2.33	2.33	2.33	4.5	13.5	13.8	1150	3320	3420	15.1	14.4	13.8
		20+25+25+25+25+35	1.74	2.18	2.18	2.18	2.18	3.05	4.5	13.5	13.8	1150	3320	3420	15.1	14.4	13.8
		20+25+25+25+25+50	1.59	1.99	1.99	1.99	1.99	3.97	4.5	13.5	13.8	1150	3310	3420	15.1	14.4	13.8
		20+25+25+25+25+60	1.50	1.88	1.88	1.88	1.88	4.50	4.5	13.5	13.8	1150	3310	3420	15.1	14.4	13.8
		20+25+25+25+25+71	1.41	1.77	1.77	1.77	1.77	5.02	4.5	13.5	13.8	1150	3310	3420	15.1	14.4	13.8
		20+25+25+25+35+35	1.64	2.05	2.05	2.05	2.86	2.86	4.5	13.5	13.8	1150	3320	3420	15.1	14.4	13.8
		20+25+25+25+35+50	1.50	1.88	1.88	1.88	2.63	3.75	4.5	13.5	13.8	1150	3310	3420	15.1	14.4	13.8
		20+25+25+25+35+60	1.42	1.78	1.78	1.78	2.49	4.26	4.5	13.5	13.8	1150	3310	3420	15.1	14.4	13.8
		20+25+25+25+50+50	1.38	1.73	1.73	1.73	3.46	3.46	4.5	13.5	13.8	1150	3310	3420	15.1	14.4	13.8
		20+25+25+35+35+35	1.54	1.93	1.93	2.70	2.70	2.70	4.5	13.5	13.8	1150	3310	3420	15.1	14.4	13.8
		20+25+25+35+35+50	1.42	1.78	1.78	2.49	2.49	3.55	4.5	13.5	13.8	1150	3310	3420	15.1	14.4	13.8
		20+25+35+35+35+35	1.46	1.82	2.55	2.55	2.55	2.55	4.5	13.5	13.8	1150	3310	3420	15.1	14.4	13.8
		20+35+35+35+35+35	1.38	2.42	2.42	2.42	2.42	2.42	4.5	13.5	13.8	1150	3310	3420	15.1	14.4	13.8
		25+25+25+25+25+25	2.25	2.25	2.25	2.25	2.25	2.25	4.5	13.5	13.8	1150	3320	3420	15.1	14.4	13.8
		25+25+25+25+25+35	2.11	2.11	2.11	2.11	2.11	2.95	4.5	13.5	13.8	1150	3320	3420	15.1	14.4	13.8
		25+25+25+25+25+50	1.93	1.93	1.93	1.93	1.93	3.86	4.5	13.5	13.8	1150	3310	3420	15.1	14.4	13.8
		25+25+25+25+25+60	1.82	1.82	1.82	1.82	1.82	4.38	4.5	13.5	13.8	1150	3310	3420	15.1	14.4	13.8
		25+25+25+25+35+35	1.99	1.99	1.99	1.99	2.78	2.78	4.5	13.5	13.8	1150	3310	3420	15.1	14.4	13.8
		25+25+25+25+35+50	1.82	1.82	1.82	1.82	2.55	3.65	4.5	13.5	13.8	1150	3310	3420	15.1	14.4	13.8
		25+25+25+25+35+60	1.73	1.73	1.73	1.73	2.42	4.15	4.5	13.5	13.8	1150	3310	3420	15.1	14.4	13.8
		25+25+25+35+35+35	1.88	1.88	1.88	2.63	2.63	2.63	4.5	13.5	13.8	1150	3310	3420	15.1	14.4	13.8
25+25+25+35+35+50	1.73	1.73	1.73	2.42	2.42	3.46	4.5	13.5	13.8	1150	3310	3420	15.1	14.4	13.8		
25+25+35+35+35+35	1.78	1.78	2.49	2.49	2.49	2.49	4.5	13.5	13.8	1150	3310	3420	15.1	14.4	13.8		

Indoor unit combination		Cooling capacity (kW)									Power consumption(W)			Standard current(A)			
		Room cooling capacity						Total capacity			Min.	Standard	Max.	220V	230V	240V	
		A	B	C	D	E	F	Min.	Standard	Max.							
Cooling operation	1 room	20	2.0	-	-	-	-	-	1.8	2.0	2.7	650	780	1100	3.6	3.4	3.3
		25	2.5	-	-	-	-	-	1.8	2.5	3.2	650	1000	1350	4.6	4.4	4.2
		35	3.5	-	-	-	-	-	1.8	3.5	3.7	650	1500	1600	6.9	6.6	6.3
		50	5.0	-	-	-	-	-	1.8	5.0	5.8	650	2150	2500	9.9	9.4	9.0
		60	6.0	-	-	-	-	-	1.8	6.0	6.7	650	2720	3000	12.5	11.9	11.4
		71	7.1	-	-	-	-	-	1.8	7.1	7.2	650	3250	3080	14.9	14.3	13.7
	2 room	20+20	2.00	2.00	-	-	-	-	3.0	4.0	5.4	740	960	1460	4.4	4.2	4.0
		20+25	2.00	2.50	-	-	-	-	3.0	4.5	5.9	740	1100	1820	5.1	4.8	4.6
		20+35	2.00	3.50	-	-	-	-	3.0	5.5	6.4	740	1500	2020	6.9	6.6	6.3
		20+50	2.00	5.00	-	-	-	-	3.0	7.0	8.5	740	2290	2820	10.5	10.1	9.6
		20+60	2.00	6.00	-	-	-	-	3.0	8.0	9.4	740	2660	3360	12.2	11.7	11.2
		20+71	2.00	7.10	-	-	-	-	3.0	9.1	9.9	740	3100	3780	14.1	13.5	12.9
		25+25	2.50	2.50	-	-	-	-	3.0	5.0	6.8	740	1420	2200	6.5	6.2	6.0
		25+35	2.50	3.50	-	-	-	-	3.0	6.0	6.9	740	1810	2320	8.3	7.9	7.6
		25+50	2.50	5.00	-	-	-	-	3.0	7.5	9.0	740	2470	3220	11.3	10.8	10.4
		25+60	2.50	6.00	-	-	-	-	3.0	8.5	9.4	740	2810	3360	12.9	12.3	11.8
		25+71	2.53	7.17	-	-	-	-	3.0	9.7	10.4	740	3350	4020	15.4	14.7	14.1
		35+35	3.50	3.50	-	-	-	-	3.0	7.0	7.4	740	2290	2820	10.5	10.1	9.6
		35+50	3.50	5.00	-	-	-	-	3.0	8.5	9.5	740	2810	3620	12.9	12.3	11.8
		35+60	3.50	6.00	-	-	-	-	3.0	9.5	10.4	740	3280	3990	15.1	14.4	13.8
		35+71	3.50	7.10	-	-	-	-	3.0	10.6	10.9	740	3760	4250	17.1	16.3	15.7
		50+50	5.00	5.00	-	-	-	-	3.0	10.0	10.8	740	3520	4050	16.2	15.5	14.8
		50+60	5.00	6.00	-	-	-	-	3.0	11.0	12.0	740	3870	4410	17.8	17.0	16.3
		50+71	4.96	7.04	-	-	-	-	3.0	12.0	12.0	740	4410	4410	20.0	19.2	18.4
		60+60	6.00	6.00	-	-	-	-	3.0	12.0	12.0	740	4410	4410	20.2	19.4	18.6
		60+71	5.73	6.77	-	-	-	-	3.0	12.5	12.5	740	4710	4710	21.4	20.5	19.6
	71+71	6.25	6.25	-	-	-	-	3.0	12.5	12.5	740	4710	4710	21.2	20.3	19.4	
	3 room	20+20+20	2.00	2.00	2.00	-	-	-	3.7	6.0	8.1	880	1530	2560	7.0	6.7	6.4
		20+20+25	2.00	2.00	2.50	-	-	-	3.7	6.5	8.6	880	1730	2700	7.9	7.6	7.3
		20+20+35	2.00	2.00	3.50	-	-	-	3.7	7.5	9.1	880	2080	3120	9.6	9.1	8.8
		20+20+50	2.00	2.00	5.00	-	-	-	3.7	9.0	11.2	880	2730	4120	12.5	12.0	11.5
		20+20+60	2.00	2.00	6.00	-	-	-	3.7	10.0	12.1	880	3280	4680	15.1	14.4	13.8
		20+20+71	2.00	2.00	7.10	-	-	-	3.7	11.1	12.6	880	3930	4710	18.0	17.3	16.5
		20+25+25	2.00	2.50	2.50	-	-	-	3.7	7.0	9.1	880	1940	3210	8.9	8.5	8.2
		20+25+35	2.00	2.50	3.50	-	-	-	3.7	8.0	9.6	880	2440	3450	11.2	10.7	10.3
		20+25+50	2.00	2.50	5.00	-	-	-	3.7	9.5	11.7	880	3130	4480	14.4	13.7	13.2
		20+25+60	2.00	2.50	6.00	-	-	-	3.7	10.5	12.6	880	3770	4800	17.3	16.6	15.9
		20+25+71	2.00	2.50	7.10	-	-	-	3.7	11.6	12.6	880	4210	4800	19.1	18.3	17.5
		20+35+35	2.00	3.50	3.50	-	-	-	3.7	9.0	10.1	880	2920	3850	13.4	12.8	12.3
		20+35+50	2.00	3.50	5.00	-	-	-	3.7	10.5	12.0	880	3770	4450	17.3	16.6	15.9
		20+35+60	2.00	3.50	6.00	-	-	-	3.7	11.5	12.6	880	4150	4800	19.1	18.2	17.5
		20+35+71	1.98	3.47	7.04	-	-	-	4.7	12.5	12.6	880	4670	4800	21.2	20.3	19.5
20+50+50		2.00	5.00	5.00	-	-	-	3.7	12.0	12.6	880	4440	4800	20.4	19.5	18.7	



MULTI-SPLIT SYSTEM

Indoor unit combination		Cooling capacity (kW)									Power consumption(W)			Standard current(A)			
		Room cooling capacity						Total capacity			Min.	Standard	Max.	220V	230V	240V	
		A	B	C	D	E	F	Min.	Standard	Max.							
Cooling operation	3 room	20+50+60	1.92	4.81	5.77	-	-	-	3.7	12.5	12.6	880	4670	4800	21.4	20.5	19.7
		20+50+71	1.77	4.43	6.29	-	-	-	3.7	12.5	12.6	881	4670	4800	21.4	20.5	19.7
		20+60+60	1.79	5.36	5.36	-	-	-	3.7	12.5	12.6	881	4670	4800	21.4	20.5	19.7
		20+60+71	1.66	4.97	5.88	-	-	-	3.7	12.5	12.6	881	4670	4800	21.4	20.5	19.7
		20+71+71	1.54	5.48	5.48	-	-	-	3.7	12.5	12.6	881	4660	4800	21.4	20.5	19.6
		25+25+25	2.50	2.50	2.50	-	-	-	3.7	7.5	9.6	880	2130	3640	9.8	9.4	9.0
		25+25+35	2.50	2.50	3.50	-	-	-	3.7	8.5	10.1	880	2650	3900	12.2	11.6	11.2
		25+25+50	2.50	2.50	5.00	-	-	-	3.7	10.0	12.6	880	3420	4800	15.7	15.0	14.4
		25+25+60	2.50	2.50	6.00	-	-	-	3.7	11.0	12.6	880	3910	4800	18.0	17.2	16.5
		25+25+71	2.58	2.58	7.33	-	-	-	3.7	12.5	12.6	880	4670	4800	21.2	20.3	19.5
		25+35+35	2.50	3.50	3.50	-	-	-	3.7	9.5	10.4	880	3130	3910	14.4	13.7	13.2
		25+35+50	2.50	3.50	5.00	-	-	-	3.7	11.0	12.6	880	3910	4800	18.0	17.2	16.5
		25+35+60	2.50	3.50	6.00	-	-	-	3.7	12.0	12.6	880	4440	4800	20.4	19.5	18.7
		25+35+71	2.39	3.34	6.77	-	-	-	3.7	12.5	12.6	880	4670	4800	21.4	20.5	19.7
		25+50+50	2.50	5.00	5.00	-	-	-	3.7	12.5	12.6	880	4670	4800	21.4	20.5	19.7
		25+50+60	2.31	4.63	5.56	-	-	-	3.7	12.5	12.6	880	4670	4800	21.4	20.5	19.7
		25+50+71	2.14	4.28	6.08	-	-	-	3.7	12.5	12.6	880	4670	4800	21.4	20.5	19.7
		25+60+60	2.16	5.17	5.17	-	-	-	3.7	12.5	12.6	880	4670	4800	21.4	20.5	19.7
		25+60+71	2.00	4.81	5.69	-	-	-	3.7	12.5	12.6	880	4670	4800	21.4	20.5	19.7
		25+71+71	1.87	5.31	5.31	-	-	-	3.7	12.5	12.6	880	4670	4800	21.4	20.5	19.7
		35+35+35	3.50	3.50	3.50	-	-	-	3.7	10.5	10.9	880	3770	4180	17.3	16.6	15.9
		35+35+50	3.50	3.50	5.00	-	-	-	3.7	12.0	12.6	880	4440	4800	20.4	19.5	18.7
		35+35+60	3.37	3.37	5.77	-	-	-	3.7	12.5	12.6	880	4670	4800	21.4	20.5	19.7
		35+35+71	3.10	3.10	6.29	-	-	-	3.7	12.5	12.6	880	4660	4800	21.2	20.3	19.4
		35+50+50	3.24	4.63	4.63	-	-	-	3.7	12.5	12.6	880	4670	4800	21.4	20.5	19.7
		35+50+60	3.02	4.31	5.17	-	-	-	3.7	12.5	12.6	880	4660	4800	21.4	20.5	19.6
		35+50+71	2.80	4.01	5.69	-	-	-	3.7	12.5	12.6	880	4660	4800	21.4	20.5	19.6
		35+60+60	2.82	4.84	4.84	-	-	-	3.7	12.5	12.6	880	4660	4800	21.4	20.5	19.6
		35+60+71	2.64	4.52	5.35	-	-	-	3.7	12.5	12.6	880	4660	4800	21.4	20.5	19.6
		35+71+71	2.47	5.01	5.01	-	-	-	3.7	12.5	12.6	880	4650	4800	21.3	20.4	19.6
	50+50+50	4.17	4.17	4.17	-	-	-	3.7	12.5	12.6	880	4660	4800	21.4	20.5	19.6	
	50+50+60	3.91	3.91	4.69	-	-	-	3.7	12.5	12.6	880	4660	4800	21.4	20.5	19.6	
	50+50+71	3.65	3.65	5.19	-	-	-	3.7	12.5	12.6	880	4650	4800	21.3	20.4	19.6	
	50+60+60	3.68	4.41	4.41	-	-	-	3.7	12.5	12.6	880	4650	4800	21.3	20.4	19.6	
	50+60+71	3.45	4.14	4.90	-	-	-	3.7	12.5	12.6	880	4650	4800	21.3	20.4	19.6	
	60+60+60	4.17	4.17	4.17	-	-	-	3.7	12.5	12.6	880	4650	4800	21.3	20.4	19.6	
	60+60+71	3.93	3.93	4.65	-	-	-	3.7	12.5	12.6	880	4650	4800	21.3	20.4	19.6	
	4 room	20+20+20+20	2.00	2.00	2.00	2.00	-	-	4.4	8.0	10.8	1100	2110	3680	9.6	9.2	8.8
		20+20+20+25	2.00	2.00	2.00	2.50	-	-	4.4	8.5	11.3	1100	2390	3890	10.9	10.4	10.0
		20+20+20+35	2.00	2.00	2.00	3.50	-	-	4.4	9.5	11.8	1100	2900	4350	13.2	12.6	12.1
		20+20+20+50	2.00	2.00	2.00	5.00	-	-	4.4	11.0	12.8	1100	3580	4800	16.3	15.6	14.9
		20+20+20+60	2.00	2.00	2.00	6.00	-	-	4.4	12.0	12.8	1100	4100	4800	18.7	17.8	17.1
20+20+20+71		1.91	1.91	1.91	6.77	-	-	4.4	12.5	12.8	1100	4730	4800	21.3	20.4	19.5	
20+20+25+25		2.00	2.00	2.50	2.50	-	-	4.4	9.0	11.8	1100	2600	4410	11.8	11.3	10.8	
20+20+25+35		2.00	2.00	2.50	3.50	-	-	4.4	10.0	12.3	1100	3210	4780	14.6	14.0	13.4	
20+20+25+50		2.00	2.00	2.50	5.00	-	-	4.4	11.5	12.8	1100	3830	4800	17.4	16.7	16.0	
20+20+25+60		2.00	2.00	2.50	6.00	-	-	4.4	12.5	12.8	1100	4740	4800	21.6	20.6	19.8	
20+20+25+71		1.84	1.84	2.30	6.53	-	-	4.4	12.5	12.8	1100	4730	4800	21.5	20.6	19.7	
20+20+35+35		2.00	2.00	3.50	3.50	-	-	4.4	11.0	12.8	1100	3580	4800	16.3	15.6	14.9	
20+20+35+50		2.00	2.00	3.50	5.00	-	-	4.4	12.5	12.8	1100	4740	4800	21.6	20.6	19.8	
20+20+35+60		1.85	1.85	3.24	5.56	-	-	4.4	12.5	12.8	1100	4730	4800	21.5	20.6	19.7	
20+20+35+71		1.71	1.71	3.00	6.08	-	-	4.4	12.5	12.8	1100	4730	4800	21.5	20.6	19.7	
20+20+50+50		1.79	1.79	4.46	4.46	-	-	4.4	12.5	12.8	1100	4730	4800	21.5	20.6	19.7	
20+20+50+60		1.67	1.67	4.17	5.00	-	-	4.4	12.5	12.8	1100	4730	4800	21.5	20.6	19.7	
20+20+50+71		1.55	1.55	3.88	5.51	-	-	4.4	12.5	12.8	1100	4720	4800	21.5	20.5	19.7	
20+20+60+60		1.56	1.56	4.69	4.69	-	-	4.4	12.5	12.8	1100	4720	4800	21.5	20.5	19.7	
20+20+60+71		1.46	1.46	4.39	5.19	-	-	4.4	12.5	12.8	1100	4720	4800	21.5	20.5	19.7	
20+20+71+71		1.37	1.37	4.88	4.88	-	-	4.4	12.5	12.8	1100	4710	4800	21.4	20.5	19.6	
20+25+25+25		2.00	2.50	2.50	2.50	-	-	4.4	9.5	12.8	1100	2900	4800	13.2	12.6	12.1	
20+25+25+35		2.00	2.50	2.50	3.50	-	-	4.4	10.5	12.8	1100	3440	4800	15.7	15.0	14.3	
20+25+25+50		2.00	2.50	2.50	5.00	-	-	4.4	12.0	12.8	1100	4100	4800	18.7	17.8	17.1	
20+25+25+60		1.92	2.40	2.40	5.77	-	-	4.4	12.5	12.8	1100	4740	4800	21.6	20.6	19.8	
20+25+25+71		1.82	2.26	2.26	6.16	-	-	4.4	12.5	12.8	1100	4730	4800	21.5	20.6	19.7	
20+25+35+35		2.00	2.50	3.50	3.50	-	-	4.4	11.5	12.8	1100	3830	4800	17.4	16.7	16.0	
20+25+35+50		1.92	2.40	3.37	4.81	-	-	4.4	12.5	12.8	1100	4740	4800	21.6	20.6	19.8	
20+25+35+60		1.79	2.23	3.13	5.36	-	-	4.4	12.5	12.8	1100	4730	4800	21.5	20.6	19.7	
20+25+35+71		1.66	2.07	2.90	5.88	-	-	4.4	12.5	12.8	1100	4730	4800	21.5	20.6	19.7	
20+25+50+50	1.72	2.16	4.31	4.31	-	-	4.4	12.5	12.8	1100	4730	4800	21.5	20.6	19.7		
20+25+50+60	1.61	2.02	4.03	4.84	-	-	4.4	12.5	12.8	1100	4720	4800	21.5	20.5	19.7		
20+25+50+71	1.51	1.88	3.77	5.35	-	-	4.4	12.5	12.8	1100	4720	4800	21.5	20.5	19.7		
20+25+60+60	1.52	1.89	4.55	4.55	-	-	4.4	12.5	12.8	1100	4720	4800	21.5	20.5	19.7		
20+25+60+71	1.42	1.78	4.26	5.04	-	-	4.4	12.5	12.8	1100	4720	4800	21.5	20.5	19.7		
20+25+71+71	1.34	1.67	4.75	4.75	-	-	4.4	12.5	12.8	1100	4700	4800	21.4	20.5	19.6		
20+35+35+35	2.00	3.50	3.50	3.50	-	-	4.4	12.5	12.8	1100	4740	4800	21.6	20.6	19.8		
20+35+35+50	1.79	3.13	3.13	4.46	-	-	4.4	12.5	12.8	1100	4730	4800	21.5	20.6	19.7		
20+35+35+60	1.67	2.92	2.92	5.00	-	-	4.4	12.5	12.8	1100	4730	4800	21.5	20.6	19.7		
20+35+35+71	1.55	2.72	2.72	5.51	-	-	4.4	12.5	12.8	1100	4720	4800	21.5	20.5	19.7		

COMBINATIONS

Indoor unit combination		Cooling capacity (kW)										Power consumption(W)			Standard current(A)		
		Room cooling capacity						Total capacity				Min.	Standard	Max.	220V	230V	240V
		A	B	C	D	E	F	Min.	Standard	Max.							
Cooling operation	4 room	20+35+50+50	1.61	2.82	4.03	4.03	-	-	4.4	12.5	12.8	1100	4720	4800	21.5	20.5	19.7
		20+35+50+60	1.52	2.65	3.79	4.55	-	-	4.4	12.5	12.8	1100	4720	4800	21.5	20.5	19.7
		20+35+50+71	1.42	2.49	3.55	5.04	-	-	4.4	12.5	12.8	1100	4720	4800	21.5	20.5	19.7
		20+35+60+60	1.43	2.50	4.29	4.29	-	-	4.4	12.5	12.8	1100	4710	4800	21.4	20.5	19.6
		20+35+60+71	1.34	2.35	4.03	4.77	-	-	4.4	12.5	12.8	1100	4710	4800	21.4	20.5	19.6
		20+50+50+50	1.47	3.68	3.68	3.68	-	-	4.4	12.5	12.8	1100	4720	4800	21.5	20.5	19.7
		20+50+50+60	1.39	3.47	3.47	4.17	-	-	4.4	12.5	12.8	1100	4710	4800	21.4	20.5	19.6
		20+50+50+71	1.31	3.27	3.27	4.65	-	-	4.4	12.5	12.8	1100	4700	4800	21.4	20.5	19.6
		20+50+60+60	1.32	3.29	3.95	3.95	-	-	4.4	12.5	12.8	1100	4700	4800	21.4	20.5	19.6
		25+25+25+25	2.50	2.50	2.50	2.50	-	-	4.4	10.0	12.8	1100	3210	4800	14.6	14.0	13.4
		25+25+25+35	2.50	2.50	2.50	3.50	-	-	4.4	11.0	12.8	1100	3580	4800	16.3	15.6	14.9
		25+25+25+50	2.50	2.50	2.50	5.00	-	-	4.4	12.5	12.8	1100	4740	4800	21.6	20.6	19.8
		25+25+25+60	2.31	2.31	2.31	5.56	-	-	4.4	12.5	12.8	1100	4730	4800	21.5	20.6	19.7
		25+25+25+71	2.14	2.14	2.14	6.08	-	-	4.4	12.5	12.8	1100	4730	4800	21.5	20.6	19.7
		25+25+35+35	2.50	2.50	3.50	3.50	-	-	4.4	12.0	12.8	1100	4100	4800	18.7	17.8	17.1
		25+25+35+50	2.31	2.31	3.24	4.63	-	-	4.4	12.5	12.8	1100	4730	4800	21.5	20.6	19.7
		25+25+35+60	2.16	2.16	3.02	5.17	-	-	4.4	12.5	12.8	1100	4730	4800	21.5	20.6	19.7
		25+25+35+71	2.00	2.00	2.80	5.69	-	-	4.4	12.5	12.8	1100	4720	4800	21.5	20.5	19.7
		25+25+50+50	2.08	2.08	4.17	4.17	-	-	4.4	12.5	12.8	1100	4730	4800	21.5	20.6	19.7
		25+25+50+60	1.95	1.95	3.91	4.69	-	-	4.4	12.5	12.8	1100	4720	4800	21.5	20.5	19.7
		25+25+50+71	1.83	1.83	3.65	5.19	-	-	4.4	12.5	12.8	1100	4720	4800	21.5	20.5	19.7
		25+25+60+60	1.84	1.84	4.41	4.41	-	-	4.4	12.5	12.8	1100	4720	4800	21.5	20.5	19.7
		25+25+60+71	1.73	1.73	4.14	4.90	-	-	4.4	12.5	12.8	1100	4710	4800	21.4	20.5	19.6
		25+25+71+71	1.63	1.63	4.62	4.62	-	-	4.4	12.5	12.8	1100	4700	4800	21.4	20.5	19.6
		25+35+35+35	2.40	3.37	3.37	3.37	-	-	4.4	12.5	12.8	1100	4740	4800	21.6	20.6	19.8
		25+35+35+50	2.16	3.02	3.02	4.31	-	-	4.4	12.5	12.8	1100	4730	4800	21.5	20.6	19.7
		25+35+35+60	2.02	2.82	2.82	4.84	-	-	4.4	12.5	12.8	1100	4720	4800	21.5	20.5	19.7
		25+35+35+71	1.88	2.64	2.64	5.35	-	-	4.4	12.5	12.8	1100	4720	4800	21.5	20.5	19.7
		25+35+50+50	1.95	2.73	3.91	3.91	-	-	4.4	12.5	12.8	1100	4720	4800	21.5	20.5	19.7
		25+35+50+60	1.84	2.57	3.68	4.41	-	-	4.4	12.5	12.8	1100	4720	4800	21.5	20.5	19.7
		25+35+50+71	1.73	2.42	3.45	4.90	-	-	4.4	12.5	12.8	1100	4710	4800	21.4	20.5	19.6
		25+35+60+60	1.74	2.43	4.17	4.17	-	-	4.4	12.5	12.8	1100	4710	4800	21.4	20.5	19.6
		25+35+60+71	1.64	2.29	3.93	4.65	-	-	4.4	12.5	12.8	1100	4700	4800	21.4	20.5	19.6
		25+50+50+50	1.79	3.57	3.57	3.57	-	-	4.4	12.5	12.8	1100	4710	4800	21.4	20.5	19.6
		25+50+50+60	1.69	3.38	3.38	4.05	-	-	4.4	12.5	12.8	1100	4710	4800	21.4	20.5	19.6
		25+50+60+60	1.60	3.21	3.85	3.85	-	-	4.4	12.5	12.8	1100	4700	4800	21.4	20.5	19.6
		35+35+35+35	3.13	3.13	3.13	3.13	-	-	4.4	12.5	12.8	1100	4730	4800	21.5	20.6	19.7
		35+35+35+50	2.82	2.82	2.82	4.03	-	-	4.4	12.5	12.8	1100	4720	4800	21.5	20.5	19.7
		35+35+35+60	2.65	2.65	2.65	4.55	-	-	4.4	12.5	12.8	1100	4720	4800	21.5	20.5	19.7
		35+35+35+71	2.49	2.49	2.49	5.04	-	-	4.4	12.5	12.8	1100	4710	4800	21.4	20.5	19.6
		35+35+50+50	2.57	2.57	3.68	3.68	-	-	4.4	12.5	12.8	1100	4720	4800	21.5	20.5	19.7
		35+35+50+60	2.43	2.43	3.47	4.17	-	-	4.4	12.5	12.8	1100	4710	4800	21.4	20.5	19.6
35+35+50+71	2.29	2.29	3.27	4.65	-	-	4.4	12.5	12.8	1100	4700	4800	21.4	20.5	19.6		
35+35+60+60	2.30	2.30	3.95	3.95	-	-	4.4	12.5	12.8	1100	4700	4800	21.4	20.5	19.6		
35+50+50+50	2.36	3.38	3.38	3.38	-	-	4.4	12.5	12.8	1100	4710	4800	21.4	20.5	19.6		
35+50+60+60	2.24	3.21	3.21	3.85	-	-	4.4	12.5	12.8	1100	4700	4800	21.4	20.5	19.6		
Cooling operation	5 room	20+20+20+20+20	2.00	2.00	2.00	2.00	2.00	-	5.1	10.0	13.3	1210	2950	4800	13.4	12.8	12.3
		20+20+20+20+25	2.00	2.00	2.00	2.00	2.50	-	5.1	10.5	13.3	1210	3200	4800	14.6	13.9	13.3
		20+20+20+20+35	2.00	2.00	2.00	2.00	3.50	-	5.1	11.5	13.3	1210	3710	4800	16.9	16.1	15.5
		20+20+20+20+50	1.92	1.92	1.92	1.92	4.81	-	5.1	12.5	13.3	1210	4430	4800	20.2	19.3	18.5
		20+20+20+20+60	1.79	1.79	1.79	1.79	5.36	-	5.1	12.5	13.3	1210	4420	4800	20.1	19.2	18.4
		20+20+20+20+71	1.66	1.66	1.66	1.66	5.88	-	5.1	12.5	13.3	1210	4410	4800	20.1	19.2	18.4
		20+20+20+25+25	2.00	2.00	2.00	2.50	2.50	-	5.1	11.0	13.3	1210	3400	4800	15.5	14.8	14.2
		20+20+20+25+35	2.00	2.00	2.00	2.50	3.50	-	5.1	12.0	13.3	1210	4090	4800	18.6	17.8	17.1
		20+20+20+25+50	1.85	1.85	1.85	2.31	4.63	-	5.1	12.5	13.3	1210	4430	4800	20.2	19.3	18.5
		20+20+20+25+60	1.72	1.72	1.72	2.16	5.17	-	5.1	12.5	13.3	1210	4420	4800	20.1	19.2	18.4
		20+20+20+25+71	1.60	1.60	1.60	2.00	5.69	-	5.1	12.5	13.3	1210	4410	4800	20.1	19.2	18.4
		20+20+20+35+35	1.92	1.92	1.92	3.37	3.37	-	5.1	12.5	13.3	1210	4430	4800	20.2	19.3	18.5
		20+20+20+35+50	1.72	1.72	1.72	3.02	4.31	-	5.1	12.5	13.3	1210	4420	4800	20.1	19.2	18.4
		20+20+20+35+60	1.61	1.61	1.61	2.82	4.84	-	5.1	12.5	13.3	1210	4410	4800	20.1	19.2	18.4
		20+20+20+35+71	1.51	1.51	1.51	2.64	5.35	-	5.1	12.5	13.3	1210	4400	4800	20.0	19.1	18.4
		20+20+20+50+50	1.56	1.56	1.56	3.91	3.91	-	5.1	12.5	13.3	1210	4410	4800	20.1	19.2	18.4
		20+20+20+50+60	1.47	1.47	1.47	3.68	4.41	-	5.1	12.5	13.3	1210	4400	4800	20.0	19.1	18.4
		20+20+20+50+71	1.38	1.38	1.38	3.45	4.90	-	5.1	12.5	13.3	1210	4390	4800	20.0	19.1	18.3
		20+20+20+60+60	1.39	1.39	1.39	4.17	4.17	-	5.1	12.5	13.3	1210	4390	4800	20.0	19.1	18.3
		20+20+20+60+71	1.31	1.31	1.31	3.93	4.65	-	5.1	12.5	13.3	1210	4380	4800	19.9	19.1	18.3
		20+20+25+25+25	2.00	2.00	2.50	2.50	2.50	-	5.1	11.5	13.3	1210	3710	4800	16.9	16.1	15.5
		20+20+25+25+35	2.00	2.00	2.50	2.50	3.50	-	5.1	12.5	13.3	1210	4440	4800	20.2	19.3	18.5
		20+20+25+25+50	1.79	1.79	2.23	2.23	4.46	-	5.1	12.5	13.3	1210	4420	4800	20.1	19.2	18.4
		20+20+25+25+60	1.67	1.67	2.08	2.08	5.00	-	5.1	12.5	13.3	1210	4410	4800	20.1	19.2	18.4
		20+20+25+25+71	1.55	1.55	1.94	1.94	5.51	-	5.1	12.5	13.3	1210	4410	4800	20.1	19.2	18.4
		20+20+25+35+35	1.85	1.85	2.31	3.24	3.24	-	5.1	12.5	13.3	1210	4430	4800	20.2	19.3	18.5
		20+20+25+35+50	1.67	1.67	2.08	2.92	4.17	-	5.1	12.5	13.3	1210	4410	4800	20.1	19.2	18.4
		20+20+25+35+60	1.56	1.56	1.95	2.73	4.69	-	5.1	12.5	13.3	1210	4410	4800	20.1	19.2	18.4
		20+20+25+35+71	1.46	1.46	1.83	2.56	5.19	-	5.1	12.5	13.3	1210	4400	4800	20.0	19.1	18.4
		20+20+25+50+50	1.52	1.52	1.89	3.79	3.79	-	5.1	12.5	13.3	1210	4400	4800	20.0	19.1	18.4
20+20+25+50+60	1.43	1.43	1.79	3.57	4.29	-	5.1	12.5	13.3	1210	4390	4800	20.0	19.1	18.3		



MULTI-SPLIT SYSTEM

Indoor unit combination		Cooling capacity (kW)										Power consumption(W)			Standard current(A)		
		Room cooling capacity						Total capacity				Min.	Standard	Max.	220V	230V	240V
		A	B	C	D	E	F	Min.	Standard	Max.							
Cooling operation	5 room	20+20+25+50+71	1.34	1.34	1.68	3.36	4.77	-	5.1	12.5	13.3	1210	4390	4800	20.0	19.1	18.3
		20+20+25+60+60	1.35	1.35	1.69	4.05	4.05	-	5.1	12.5	13.3	1210	4390	4800	20.0	19.1	18.3
		20+20+35+35+35	1.72	1.72	3.02	3.02	3.02	-	5.1	12.5	13.3	1210	4420	4800	20.1	19.2	18.4
		20+20+35+35+50	1.56	1.56	2.73	2.73	3.91	-	5.1	12.5	13.3	1210	4410	4800	20.1	19.2	18.4
		20+20+35+35+60	1.47	1.47	2.57	2.57	4.41	-	5.1	12.5	13.3	1210	4400	4800	20.0	19.1	18.4
		20+20+35+35+71	1.38	1.38	2.42	2.42	4.90	-	5.1	12.5	13.3	1210	4390	4800	20.0	19.1	18.3
		20+20+35+50+50	1.43	1.43	2.50	3.57	3.57	-	5.1	12.5	13.3	1210	4390	4800	20.0	19.1	18.3
		20+20+35+50+60	1.35	1.35	2.36	3.38	4.05	-	5.1	12.5	13.3	1210	4390	4800	20.0	19.1	18.3
		20+20+35+60+60	1.28	1.28	2.24	3.85	3.85	-	5.1	12.5	13.3	1210	4380	4800	19.9	19.1	18.3
		20+20+50+50+50	1.32	1.32	3.29	3.29	3.29	-	5.1	12.5	13.3	1210	4380	4800	19.9	19.1	18.3
		20+25+25+25+25	2.00	2.50	2.50	2.50	2.50	-	5.1	12.0	13.3	1210	4090	4800	18.6	17.8	17.1
		20+25+25+25+35	1.92	2.40	2.40	2.40	3.37	-	5.1	12.5	13.3	1210	4430	4800	20.2	19.3	18.5
		20+25+25+25+50	1.72	2.16	2.16	2.16	4.31	-	5.1	12.5	13.3	1210	4420	4800	20.1	19.2	18.4
		20+25+25+25+60	1.61	2.02	2.02	2.02	4.84	-	5.1	12.5	13.3	1210	4410	4800	20.1	19.2	18.4
		20+25+25+25+71	1.51	1.88	1.88	1.88	5.35	-	5.1	12.5	13.3	1210	4400	4800	20.0	19.1	18.4
		20+25+25+35+35	1.79	2.23	2.23	3.13	3.13	-	5.1	12.5	13.3	1210	4420	4800	20.1	19.2	18.4
		20+25+25+35+50	1.61	2.02	2.02	2.82	4.03	-	5.1	12.5	13.3	1210	4410	4800	20.1	19.2	18.4
		20+25+25+35+60	1.52	1.89	1.89	2.65	4.55	-	5.1	12.5	13.3	1210	4400	4800	20.0	19.1	18.4
		20+25+25+35+71	1.42	1.78	1.78	2.49	5.04	-	5.1	12.5	13.3	1210	4390	4800	20.0	19.1	18.3
		20+25+25+50+50	1.47	1.84	1.84	3.68	3.68	-	5.1	12.5	13.3	1210	4400	4800	20.0	19.1	18.4
		20+25+25+50+60	1.39	1.74	1.74	3.47	4.17	-	5.1	12.5	13.3	1210	4390	4800	20.0	19.1	18.3
		20+25+25+50+71	1.31	1.64	1.64	3.27	4.65	-	5.1	12.5	13.3	1210	4380	4800	19.9	19.1	18.3
		20+25+25+60+60	1.32	1.64	1.64	3.95	3.95	-	5.1	12.5	13.3	1210	4380	4800	19.9	19.1	18.3
		20+25+35+35+35	1.67	2.08	2.92	2.92	2.92	-	5.1	12.5	13.3	1210	4410	4800	20.1	19.2	18.4
		20+25+35+35+50	1.52	1.89	2.65	2.65	3.79	-	5.1	12.5	13.3	1210	4400	4800	20.0	19.1	18.4
		20+25+35+35+60	1.43	1.79	2.50	2.50	4.29	-	5.1	12.5	13.3	1210	4390	4800	20.0	19.1	18.3
		20+25+35+35+71	1.34	1.68	2.35	2.35	4.77	-	5.1	12.5	13.3	1210	4390	4800	20.0	19.1	18.3
		20+25+35+50+50	1.39	1.74	2.43	3.47	3.47	-	5.1	12.5	13.3	1210	4390	4800	20.0	19.1	18.3
		20+25+35+50+60	1.32	1.64	2.30	3.29	3.95	-	5.1	12.5	13.3	1210	4380	4800	19.9	19.1	18.3
		20+25+50+50+50	1.28	1.60	3.21	3.21	3.21	-	5.1	12.5	13.3	1210	4380	4800	19.9	19.1	18.3
		20+35+35+35+35	1.56	2.73	2.73	2.73	2.73	-	5.1	12.5	13.3	1210	4410	4800	20.1	19.2	18.4
		20+35+35+35+50	1.43	2.50	2.50	2.50	3.57	-	5.1	12.5	13.3	1210	4390	4800	20.0	19.1	18.3
		20+35+35+35+60	1.35	2.36	2.36	2.36	4.05	-	5.1	12.5	13.3	1210	4390	4800	20.0	19.1	18.3
		20+35+35+50+50	1.32	2.30	2.30	3.29	3.29	-	5.1	12.5	13.3	1210	4380	4800	19.9	19.1	18.3
		25+25+25+25+25	2.50	2.50	2.50	2.50	2.50	-	5.1	12.5	13.3	1210	4440	4800	20.2	19.3	18.5
		25+25+25+25+35	2.31	2.31	2.31	2.31	3.24	-	5.1	12.5	13.3	1210	4430	4800	20.2	19.3	18.5
		25+25+25+25+50	2.08	2.08	2.08	2.08	4.17	-	5.1	12.5	13.3	1210	4410	4800	20.1	19.2	18.4
		25+25+25+25+60	1.95	1.95	1.95	1.95	4.69	-	5.1	12.5	13.3	1210	4410	4800	20.1	19.2	18.4
		25+25+25+35+35	2.16	2.16	2.16	3.02	3.02	-	5.1	12.5	13.3	1210	4420	4800	20.1	19.2	18.4
		25+25+25+35+50	1.95	1.95	1.95	2.73	3.91	-	5.1	12.5	13.3	1210	4410	4800	20.1	19.2	18.4
		25+25+25+35+60	1.84	1.84	1.84	2.57	4.41	-	5.1	12.5	13.3	1210	4400	4800	20.0	19.1	18.4
		25+25+25+35+71	1.73	1.73	1.73	2.42	4.90	-	5.1	12.5	13.3	1210	4390	4800	20.0	19.1	18.3
25+25+25+50+50	1.79	1.79	1.79	3.57	3.57	-	5.1	12.5	13.3	1210	4390	4800	20.0	19.1	18.3		
25+25+25+50+60	1.69	1.69	1.69	3.38	4.05	-	5.1	12.5	13.3	1210	4390	4800	20.0	19.1	18.3		
25+25+25+60+60	1.60	1.60	1.60	3.85	3.85	-	5.1	12.5	13.3	1210	4380	4800	19.9	19.1	18.3		
25+25+35+35+35	2.02	2.02	2.82	2.82	2.82	-	5.1	12.5	13.3	1210	4410	4800	20.1	19.2	18.4		
25+25+35+35+50	1.84	1.84	2.57	2.57	3.68	-	5.1	12.5	13.3	1210	4400	4800	20.0	19.1	18.4		
25+25+35+35+60	1.74	1.74	2.43	2.43	4.17	-	5.1	12.5	13.3	1210	4390	4800	20.0	19.1	18.3		
25+25+35+35+71	1.64	1.64	2.29	2.29	4.65	-	5.1	12.5	13.3	1210	4380	4800	19.9	19.1	18.3		
25+25+35+50+50	1.69	1.69	2.36	3.38	3.38	-	5.1	12.5	13.3	1210	4390	4800	20.0	19.1	18.3		
25+25+35+50+60	1.60	1.60	2.24	3.21	3.85	-	5.1	12.5	13.3	1210	4380	4800	19.9	19.1	18.3		
25+35+35+35+35	1.89	2.65	2.65	2.65	2.65	-	5.1	12.5	13.3	1210	4400	4800	20.0	19.1	18.4		
25+35+35+35+50	1.74	2.43	2.43	2.43	3.47	-	5.1	12.5	13.3	1210	4390	4800	20.0	19.1	18.3		
25+35+35+35+60	1.64	2.30	2.30	2.30	3.95	-	5.1	12.5	13.3	1210	4380	4800	19.9	19.1	18.3		
25+35+35+50+50	1.60	2.24	2.24	3.21	3.21	-	5.1	12.5	13.3	1210	4380	4800	19.9	19.1	18.3		
35+35+35+35+35	2.50	2.50	2.50	2.50	2.50	-	5.1	12.5	13.3	1210	4390	4800	20.0	19.1	18.3		
35+35+35+35+50	2.30	2.30	2.30	2.30	3.29	-	5.1	12.5	13.3	1210	4380	4800	19.9	19.1	18.3		
6 room	20+20+20+20+20+20	2.00	2.00	2.00	2.00	2.00	2.00	5.5	12.0	13.6	1280	3750	4620	17.1	16.3	15.6	
	20+20+20+20+20+25	2.00	2.00	2.00	2.00	2.00	2.50	5.5	12.5	13.3	1280	4010	4800	18.2	17.5	16.7	
	20+20+20+20+20+35	1.85	1.85	1.85	1.85	1.85	3.24	5.5	12.5	13.3	1280	4000	4800	18.2	17.4	16.7	
	20+20+20+20+20+50	1.67	1.67	1.67	1.67	1.67	4.17	5.5	12.5	13.3	1280	3990	4800	18.2	17.4	16.6	
	20+20+20+20+20+60	1.56	1.56	1.56	1.56	1.56	4.69	5.5	12.5	13.3	1280	3990	4800	18.2	17.4	16.6	
	20+20+20+20+20+71	1.46	1.46	1.46	1.46	1.46	5.19	5.5	12.5	13.8	1280	3980	4800	18.1	17.3	16.6	
	20+20+20+20+25+25	1.92	1.92	1.92	1.92	2.40	2.40	5.5	12.5	13.8	1280	4000	4800	18.2	17.4	16.7	
	20+20+20+20+25+35	1.79	1.79	1.79	1.79	2.23	3.13	5.5	12.5	13.8	1280	4000	4800	18.2	17.4	16.7	
	20+20+20+20+25+50	1.61	1.61	1.61	1.61	2.02	4.03	5.5	12.5	13.8	1280	3990	4800	18.2	17.4	16.6	
	20+20+20+20+25+60	1.52	1.52	1.52	1.52	1.89	4.55	5.5	12.5	13.8	1280	3990	4800	18.2	17.4	16.6	
	20+20+20+20+35+35	1.67	1.67	1.67	1.67	2.92	2.92	5.5	12.5	13.8	1280	3990	4800	18.2	17.4	16.6	
	20+20+20+20+35+50	1.52	1.52	1.52	1.52	2.65	3.79	5.5	12.5	13.8	1280	3990	4800	18.2	17.4	16.6	
	20+20+20+20+35+60	1.43	1.43	1.43	1.43	2.50	4.29	5.5	12.5	13.8	1280	3980	4800	18.1	17.3	16.6	
	20+20+20+20+35+71	1.34	1.34	1.34	1.34	2.35	4.77	5.5	12.5	13.8	1280	3980	4800	18.1	17.3	16.6	
	20+20+20+20+50+50	1.39	1.39	1.39	1.39	3.47	3.47	5.5	12.5	13.8	1280	3980	4800	18.1	17.3	16.6	
	20+20+20+20+50+60	1.32	1.32	1.32	1.32	3.29	3.95	5.5	12.5	13.8	1280	3970	4800	18.1	17.3	16.6	
	20+20+20+25+25+25	1.85	1.85	1.85	2.31	2.31	2.31	5.5	12.5	13.8	1280	4000	4800	18.2	17.4	16.7	
	20+20+20+25+25+35	1.72	1.72	1.72	2.16	2.16	3.02	5.5	12.5	13.8	1280	4000	4800	18.2	17.4	16.7	
20+20+20+25+25+50	1.56	1.56	1.56	1.95	1.95	3.91	5.5										

COMBINATIONS

Indoor unit combination		Cooling capacity (kW)									Power consumption(W)			Standard current(A)			
		Room cooling capacity						Total capacity			Min.	Standard	Max.	220V	230V	240V	
		A	B	C	D	E	F	Min.	Standard	Max.							
Cooling operation	6 room	20+20+20+25+25+71	1.38	1.38	1.38	1.73	1.73	4.90	5.5	12.5	13.8	1280	3980	4800	18.1	17.3	16.6
		20+20+20+25+35+35	1.61	1.61	1.61	2.02	2.82	2.82	5.5	12.5	13.8	1280	3990	4800	18.2	17.4	16.6
		20+20+20+25+35+50	1.47	1.47	1.47	1.84	2.57	3.68	5.5	12.5	13.8	1280	3980	4800	18.1	17.3	16.6
		20+20+20+25+35+60	1.39	1.39	1.39	1.74	2.43	4.17	5.5	12.5	13.8	1280	3980	4800	18.1	17.3	16.6
		20+20+20+25+35+71	1.31	1.31	1.31	1.64	2.29	4.65	5.5	12.5	13.8	1280	3970	4800	18.1	17.3	16.6
		20+20+20+25+50+50	1.35	1.35	1.35	1.69	3.38	3.38	5.5	12.5	13.8	1280	3980	4800	18.1	17.3	16.6
		20+20+20+25+50+60	1.28	1.28	1.28	1.60	3.21	3.85	5.5	12.5	13.8	1280	3970	4800	18.1	17.3	16.6
		20+20+20+35+35+35	1.52	1.52	1.52	2.65	2.65	2.65	5.5	12.5	13.8	1280	3990	4800	18.2	17.4	16.6
		20+20+20+35+35+50	1.39	1.39	1.39	2.43	2.43	3.47	5.5	12.5	13.8	1280	3980	4800	18.1	17.3	16.6
		20+20+20+35+35+60	1.32	1.32	1.32	2.30	2.30	3.95	5.5	12.5	13.8	1280	3970	4800	18.1	17.3	16.6
		20+20+20+35+50+50	1.28	1.28	1.28	2.24	3.21	3.21	5.5	12.5	13.8	1280	3970	4800	18.1	17.3	16.6
		20+20+25+25+25+25	1.79	1.79	2.23	2.23	2.23	2.23	5.5	12.5	13.8	1280	4000	4800	18.2	17.4	16.7
		20+20+25+25+25+35	1.67	1.67	2.08	2.08	2.08	2.92	5.5	12.5	13.8	1280	3990	4800	18.2	17.4	16.6
		20+20+25+25+25+50	1.52	1.52	1.89	1.89	1.89	3.79	5.5	12.5	13.8	1280	3990	4800	18.2	17.4	16.6
		20+20+25+25+25+60	1.43	1.43	1.79	1.79	1.79	4.29	5.5	12.5	13.8	1280	3980	4800	18.1	17.3	16.6
		20+20+25+25+25+71	1.34	1.34	1.68	1.68	1.68	4.77	5.5	12.5	13.8	1280	3980	4800	18.1	17.3	16.6
		20+20+25+25+35+35	1.56	1.56	1.95	1.95	2.73	2.73	5.5	12.5	13.8	1280	3990	4800	18.2	17.4	16.6
		20+20+25+25+35+50	1.43	1.43	1.79	1.79	2.50	3.57	5.5	12.5	13.8	1280	3980	4800	18.1	17.3	16.6
		20+20+25+25+35+60	1.35	1.35	1.69	1.69	2.36	4.05	5.5	12.5	13.8	1280	3980	4800	18.1	17.3	16.6
		20+20+25+25+50+50	1.32	1.32	1.64	1.64	3.29	3.29	5.5	12.5	13.8	1280	3970	4800	18.1	17.3	16.6
		20+20+25+35+35+35	1.47	1.47	1.84	2.57	2.57	2.57	5.5	12.5	13.8	1280	3980	4800	18.1	17.3	16.6
		20+20+25+35+35+50	1.35	1.35	1.69	2.36	2.36	3.38	5.5	12.5	13.8	1280	3980	4800	18.1	17.3	16.6
		20+20+25+35+35+60	1.28	1.28	1.60	2.24	2.24	3.85	5.5	12.5	13.8	1280	3970	4800	18.1	17.3	16.6
		20+20+35+35+35+35	1.39	1.39	2.43	2.43	2.43	2.43	5.5	12.5	13.8	1280	3980	4800	18.1	17.3	16.6
		20+20+35+35+35+50	1.28	1.28	2.24	2.24	2.24	3.21	5.5	12.5	13.8	1280	3970	4800	18.1	17.3	16.6
		20+25+25+25+25+25	1.72	2.16	2.16	2.16	2.16	2.16	5.5	12.5	13.8	1280	4000	4800	18.2	17.4	16.7
		20+25+25+25+25+35	1.61	2.02	2.02	2.02	2.02	2.82	5.5	12.5	13.8	1280	3990	4800	18.2	17.4	16.6
		20+25+25+25+25+50	1.47	1.84	1.84	1.84	1.84	3.68	5.5	12.5	13.8	1280	3980	4800	18.1	17.3	16.6
		20+25+25+25+25+60	1.39	1.74	1.74	1.74	1.74	4.17	5.5	12.5	13.8	1280	3980	4800	18.1	17.3	16.6
		20+25+25+25+25+71	1.31	1.64	1.64	1.64	1.64	4.65	5.5	12.5	13.8	1280	3970	4800	18.1	17.3	16.6
		20+25+25+25+35+35	1.52	1.89	1.89	1.89	2.65	2.65	5.5	12.5	13.8	1280	3990	4800	18.2	17.4	16.6
		20+25+25+25+35+50	1.39	1.74	1.74	1.74	2.43	3.47	5.5	12.5	13.8	1280	3980	4800	18.1	17.3	16.6
		20+25+25+25+35+60	1.32	1.64	1.64	1.64	2.30	3.95	5.5	12.5	13.8	1280	3970	4800	18.1	17.3	16.6
		20+25+25+25+50+50	1.28	1.60	1.60	1.60	3.21	3.21	5.5	12.5	13.8	1280	3970	4800	18.1	17.3	16.6
		20+25+25+35+35+35	1.43	1.79	1.79	2.50	2.50	2.50	5.5	12.5	13.8	1280	3980	4800	18.1	17.3	16.6
		20+25+25+35+35+50	1.32	1.64	1.64	2.30	2.30	3.29	5.5	12.5	13.8	1280	3970	4800	18.1	17.3	16.6
		20+25+35+35+35+35	1.35	1.69	2.36	2.36	2.36	2.36	5.5	12.5	13.8	1280	3980	4800	18.1	17.3	16.6
		20+35+35+35+35+35	1.28	2.24	2.24	2.24	2.24	2.24	5.5	12.5	13.8	1280	3970	4800	18.1	17.3	16.6
		25+25+25+25+25+25	2.08	2.08	2.08	2.08	2.08	2.08	5.5	12.5	13.8	1280	3990	4800	18.2	17.4	16.6
		25+25+25+25+25+35	1.95	1.95	1.95	1.95	1.95	2.73	5.5	12.5	13.8	1280	3990	4800	18.2	17.4	16.6
25+25+25+25+25+50	1.79	1.79	1.79	1.79	1.79	3.57	5.5	12.5	13.8	1280	3980	4800	18.1	17.3	16.6		
25+25+25+25+25+60	1.69	1.69	1.69	1.69	1.69	4.05	5.5	12.5	13.8	1280	3980	4800	18.1	17.3	16.6		
25+25+25+25+35+35	1.84	1.84	1.84	1.84	2.57	2.57	5.5	12.5	13.8	1280	3980	4800	18.1	17.3	16.6		
25+25+25+25+35+50	1.69	1.69	1.69	1.69	2.36	3.38	5.5	12.5	13.8	1280	3980	4800	18.1	17.3	16.6		
25+25+25+25+35+60	1.60	1.60	1.60	1.60	2.24	3.85	5.5	12.5	13.8	1280	3970	4800	18.1	17.3	16.6		
25+25+25+35+35+35	1.74	1.74	1.74	2.43	2.43	2.43	5.5	12.5	13.8	1280	3980	4800	18.1	17.3	16.6		
25+25+25+35+35+50	1.60	1.60	1.60	2.24	2.24	3.21	5.5	12.5	13.8	1280	3970	4800	18.1	17.3	16.6		
25+25+35+35+35+35	1.64	1.64	2.30	2.30	2.30	2.30	5.5	12.5	13.8	1280	3970	4800	18.1	17.3	16.6		

CONTROL SYSTEM

Wired Remote Control (option)

RC-EX3A

Advanced wired remote control

The RC-EX3A controller enables extensive access to service and maintenance data combined with easy to use full dot LCD backlight display. All settings are changed by tapping the touch screen panel.



- **Economy & Timer:**
Peak cut timer. Home Leave Operation. Energy-saving operation.
- **Comfort:**
Hi power operation. Automatic fan speed. Outdoor silent mode.
- **Convenience:**
Multi language settings. LCD contrast setting. Function switch. External Input/Output Function
- **Service:**
Error code display. Operation data display. Backup Control.

RC-E5

Wired remote control

The RC-E5 controller enables extensive access to service and maintenance technical data combined with easy to use functions and a clear LCD display.



- **Weekly timer function as standard**
- **Timer operation**
- **Run hour metres to facilitate maintenance checking**
- **Room temperature controlled by the remote control sensor**
- **Changeable set temperature ranges**

RCH-E3

Simple wired remote control

Designed especially for hotel rooms, the controller's buttons are limited only to the minimum required functions such as ON/OFF, mode, temperature setting and fan speed. It is really simple and easy to use.



- **Up to 16 units :**
It can control up to 16 indoor units with pressing the AIRCON No. button
- **AUTO restart**
This function allows starting the air conditioner automatically when power supply is restored after power failure or by turning on the power switch.

Wireless remote control (option)

For wireless control simply insert the infrared receiver kit on a corner of the panel.

RCN-TC-5AW-E3
(FDTC-VH1,VH)



RCN-TC-24W-E2
(FDTC-VF)



RCN-KIT4-E2
(FDUM-VH)



RCN-E-E3
(FDE-VH)



CONTROL OPTION

Wired remote control can be connected

Model	Interface	Remote Control
SRK-ZSX-WF*, -W, -S SRK-ZR-WF*, -W, -S SRK-ZS-WF*, -W, -S SRK-ZTL* SRF-ZS, ZSX, ZMX SRR-ZS, ZM	SC-BIKN2-E	RC-EX3A RC-E5
FDTC-VH1, VH, VF FDUM50VH FDE50VH	not required	

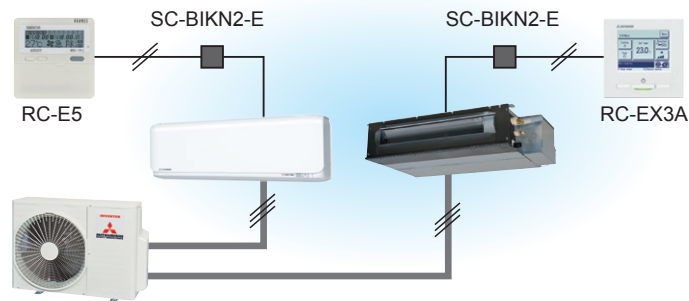

Can be connected to SUPERLINK-II

Model	Interface	Remote Control
SRK-ZSX-WF*, -W, -S SRK-ZR-WF*, -W, -S SRK-ZS-WF*, -W, -S SRK-ZTL* SRF-ZS, ZSX, ZMX SRR-ZS, ZM	SC-BIKN2-E SC-ADNA-E	RC-EX3A RC-E5
FDTC-VH1, VH, VF FDUM50VH FDE50VH	SC-ADNA-E	

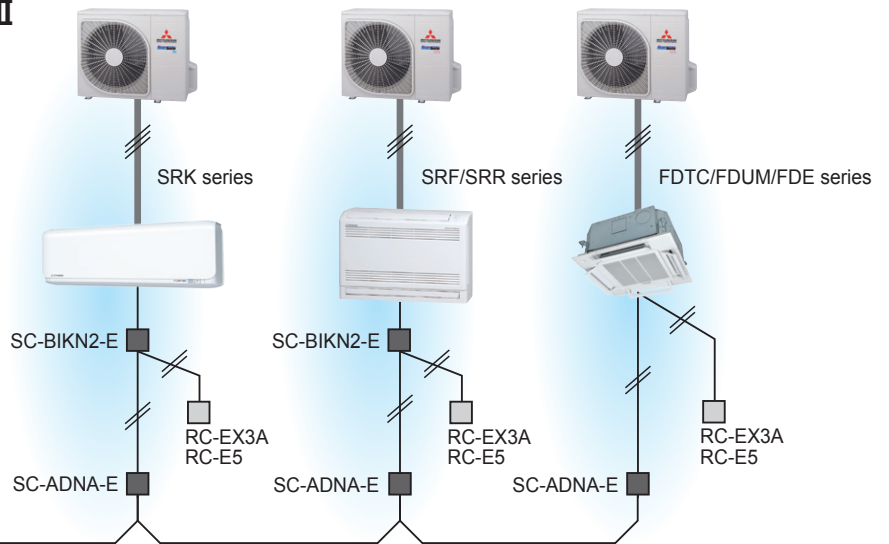

External switch connection CnT

All indoor units are equipped with an additional connection point - CnT - to connect indoor units to an external ON/OFF switch; e.g. time clock, fire alarm, etc.



Remote surveillance system



Card key on-off

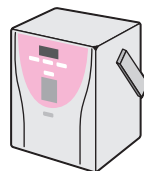

Humidifier linkage

Model	Interface
SRK-ZSX-WF*, -W, -S SRK-ZR-WF*, -W, -S SRK-ZS-WF*, -W, -S SRK-ZTL* SRF-ZS, ZSX, ZMX SRR-ZS, ZM	SC-BIKN2-E
FDTC-VH1, VH, VF FDUM50VH FDE50VH	not required

* Wired Remote control, SUPERLINK-II and CnT can be used but required SC-BIKN2 connected to CNS and Wireless LAN control function will be no longer available.

Wireless Adaptors

airconwithme

Model : INAWMMH1001000

EU/EEA market only

* These are developed by HMS Industrial Networks.



Please access the followings for details.

URL <http://www.airconwithme.com>

email info@airconwithme.com

DIMENSIONS (Unit: mm)

SRK20ZSX-WF, -WFB, -WFT, -W
 SRK25ZSX-WF, -WFB, -WFT, -W
 SRK35ZSX-WF, -WFB, -WFT, -W
 SRK50ZSX-WF, -WFB, -WFT, -W
 SRK60ZSX-WF, -WFB, -WFT, -W
 SRK20ZSX-S SRK25ZSX-S SRK35ZSX-S
 SRK50ZSX-S SRK60ZSX-S

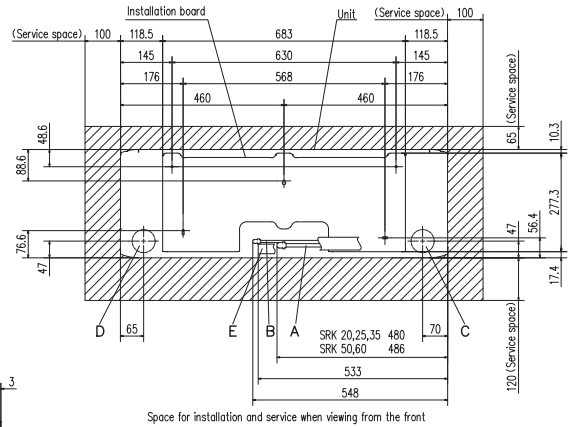
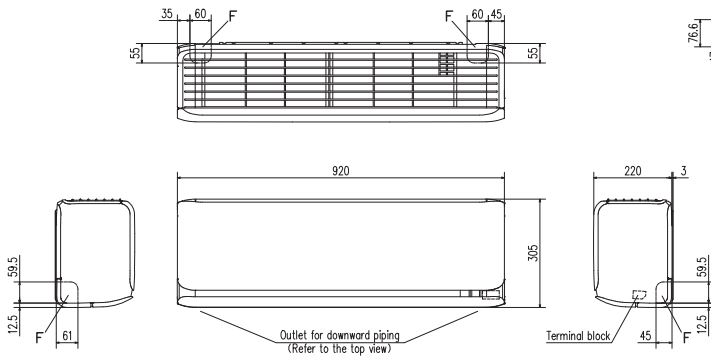

SRK63ZR-WF, -W SRK71ZR-WF, -W
 SRK80ZR-WF, -W SRK100ZR-WF, -W
 SRK63ZR-S SRK71ZR-S
 SRK80ZR-S SRK100ZR-S

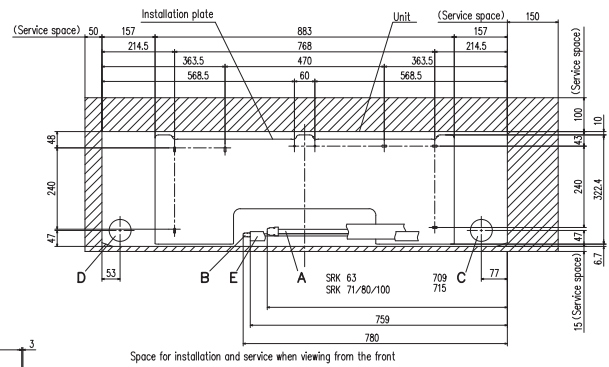
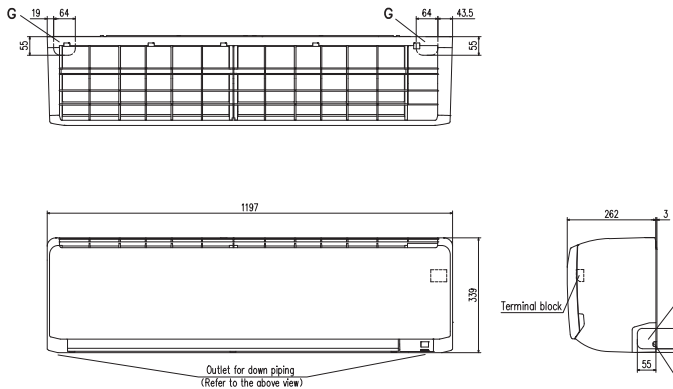

SRK15ZS-WF, -WFB, -WFT
 SRK20ZS-WF, -WFB, -WFT, -W
 SRK25ZS-WF, -WFB, -WFT, -W
 SRK35ZS-WF, -WFB, -WFT, -W
 SRK50ZS-WF, -WFB, -WFT, -W
 SRK20ZS-S, -SB, -ST SRK25ZS-S, -SB, -ST
 SRK35ZS-S, -SB, -ST SRK50ZS-S, -SB, -ST

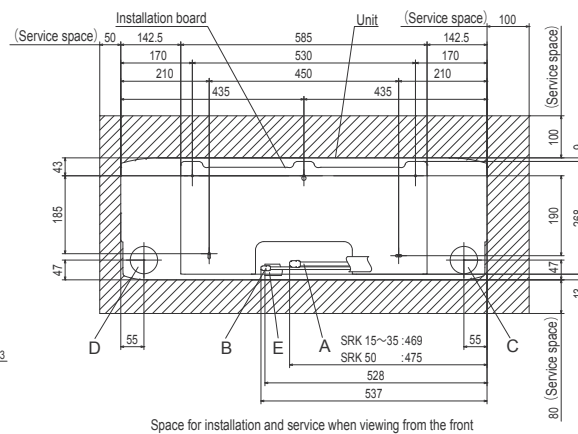
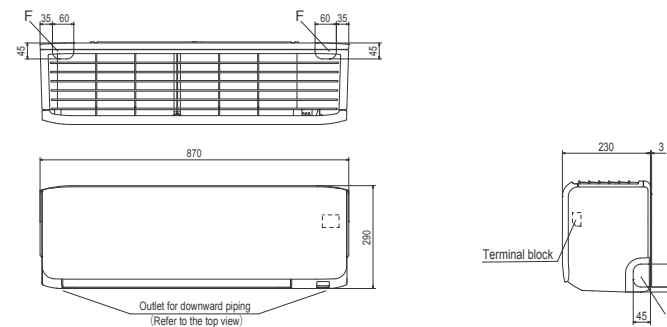

INDOOR UNIT

SRK15ZTL-W SRK20ZTL-W SRK25ZTL-W SRK35ZTL-W SRK50ZTL-W

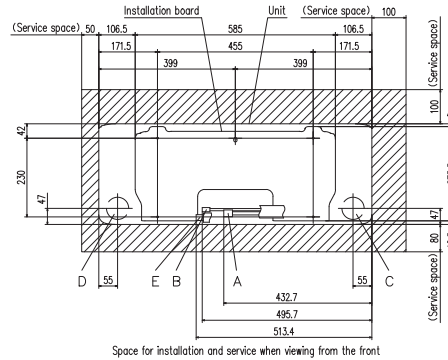
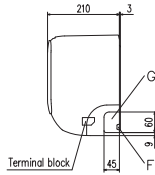
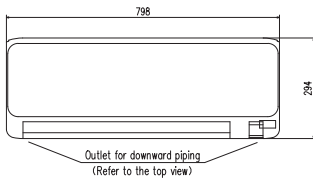

Symbol	Content
A	Gas piping SRK 15,20,25,35 $\phi 9.52 (3/8")$ (Flare) SRK 50 $\phi 12.7 (1/2")$ (Flare)
B	Liquid piping $\phi 6.35 (1/4")$ (Flare)
C	Hole on wall for right rear piping ($\phi 65$)
D	Hole on wall for left rear piping ($\phi 65$)
E	Drain hose VP16
F	Outlet for wiring (on both side)
G	Outlet for piping (on both side)

SRK63ZTL-W SRK71ZTL-W

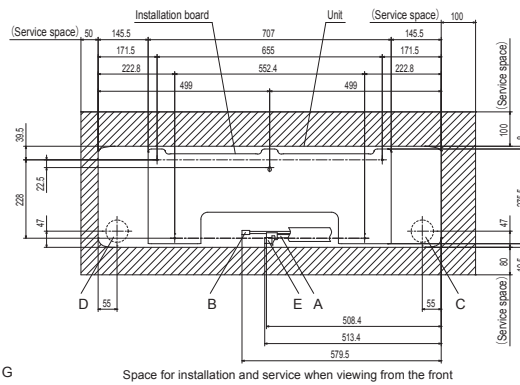
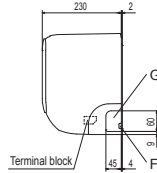
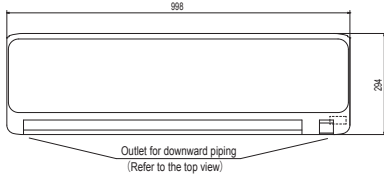
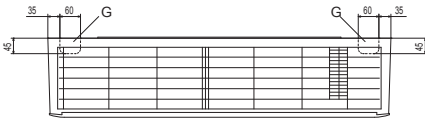

Symbol	Content
A	Gas piping $\phi 12.7 (1/2")$ (Flare)
B	Liquid piping $\phi 6.35 (1/4")$ (Flare)
C	Hole on wall for right rear piping ($\phi 65$)
D	Hole on wall for left rear piping ($\phi 65$)
E	Drain hose VP16
F	Outlet for wiring (on both side)
G	Outlet for piping (on both side)

SRK25ZSP-W1 SRK35ZSP-W1 SRK45ZSP-W1 SRK50ZSP-W1 SKM15ZSP-W SKM20ZSP-W SKM25ZSP-W SKM35ZSP-W

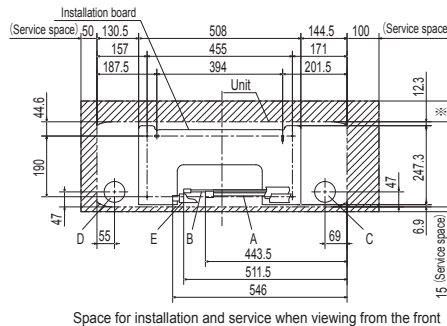
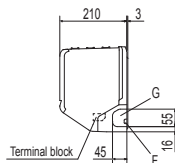
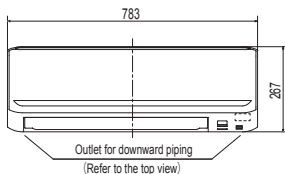
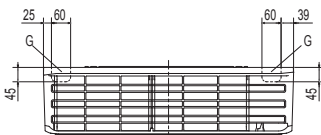

**	Service space	65
	Recommendation	80

Symbol	Content
A	Gas piping SRK25,35 SKM15~35 $\phi 9.52 (3/8")$ (Flare) SRK45,50 $\phi 12.7 (1/2")$ (Flare)
B	Liquid piping $\phi 6.35 (1/4")$ (Flare)
C	Hole on wall for right rear piping ($\phi 65$)
D	Hole on wall for left rear piping ($\phi 65$)
E	Drain hose VP16
F	Outlet for wiring
G	Outlet for piping (on both side)

DIMENSIONS (Unit: mm)

INDOOR UNIT

FDUM50VH

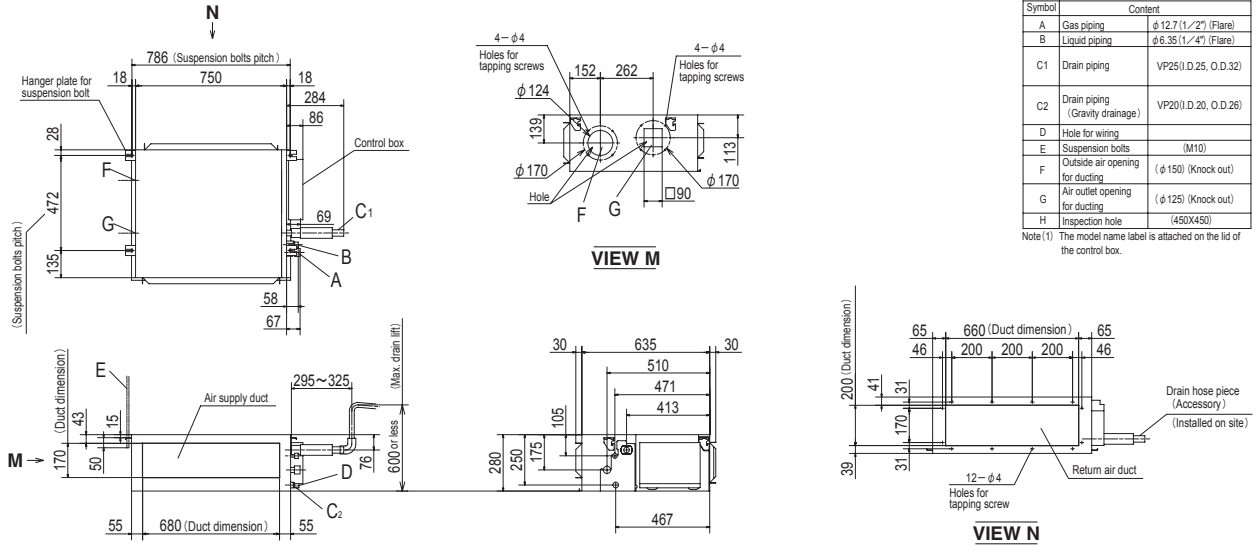

FDE50VH

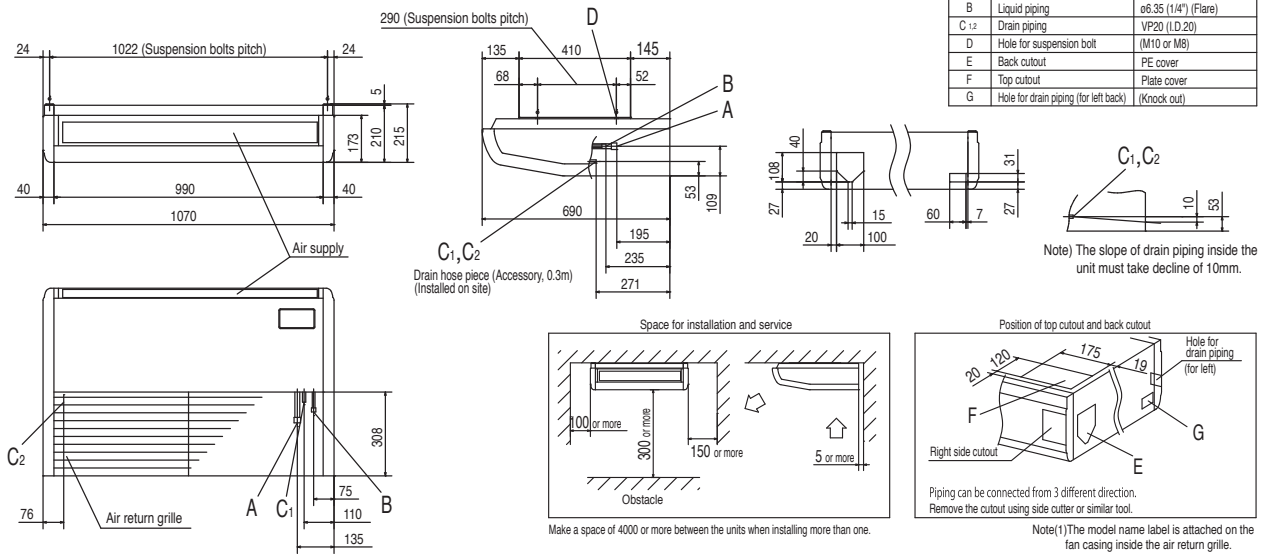

OUTDOOR UNIT

SRC20ZSX-W,-S SRC25ZSX-W,-S SRC35ZSX-W,-S SRC40ZSX-W1,-S SRC50ZSX-W3,-W2,-S SRC60ZSX-W3,-W1,-S SRC63ZR-W,-S SRC63ZTL-W SRC71ZTL-W

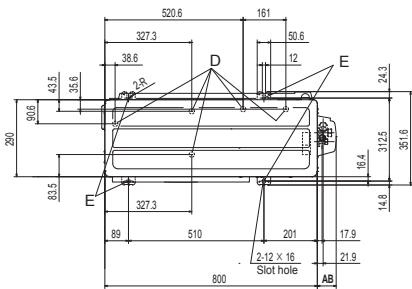

Symbol	Content
A	Service valve connection (gas side) 20,25,35 $\phi 9.52(3/8")$ (Flare) 40,50,60,63,71 $\phi 12.7(1/2")$ (Flare)
B	Service valve connection (liquid side) $\phi 6.35(1/4")$ (Flare)
C	Pipe/cable draw-out hole
D	Drain discharge hole $\phi 20 \times 5$ places
E	Anchor bolt hole M10-12 $\times 4$ places

Dimensions	Minimum installation space			
	I	II	III	IV
L1	Open	280	280	180
L2	100	75	Open	Open
L3	100	80	80	80
L4	250	Open	250	Open

	AA	AB
ZSX	93	71.2
ZR	94.5	71
ZTL	94.5	71

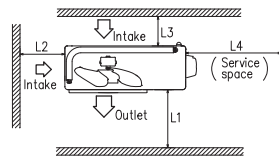
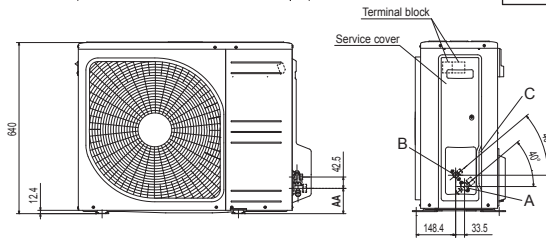

* The ZSX / ZR series does not have fin guard.

SRC50ZS-W,-S SRC25ZMX-S SRC35ZMX-S SRC50ZTL-W SRC45ZSP-W1,-S SRC50ZSP-W1

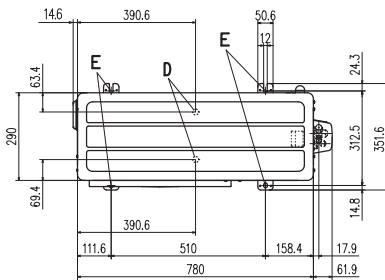

Symbol	Content
A	Service valve connection (gas side) ZMX: $\phi 9.52(3/8")$ (Flare) ZS,ZTL,ZSP: $\phi 12.7(1/2")$ (Flare)
B	Service valve connection (liquid side) $\phi 6.35(1/4")$ (Flare)
C	Pipe/cable draw-out hole
D	Drain discharge hole $\phi 20 \times 2$ places
E	Anchor bolt hole M10-12 $\times 4$ places

	Installation space
L1	280 or more
L2	100 or more
L3	80 or more
L4	250 or more

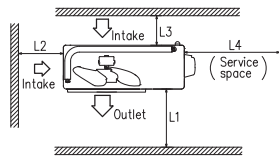
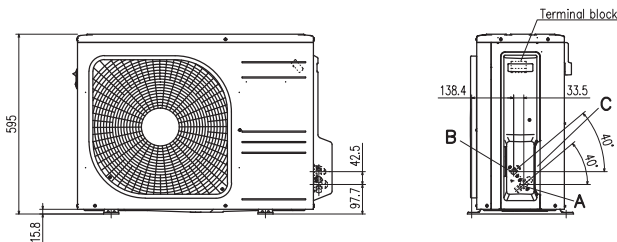

SRC20ZS-W,-S SRC25ZS-W2,-S SRC35ZS-W2,-S

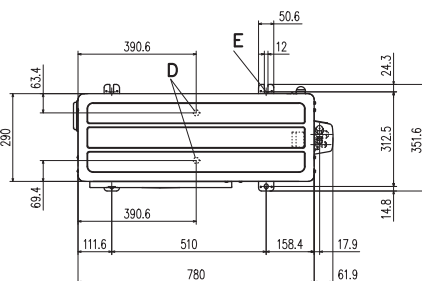

Symbol	Content
A	Service valve connection (gas side) $\phi 9.52(3/8")$ (Flare)
B	Service valve connection (liquid side) $\phi 6.35(1/4")$ (Flare)
C	Pipe/cable draw-out hole
D	Drain discharge hole $\phi 20 \times 2$ places
E	Anchor bolt hole M10-12 $\times 4$ places

	Installation space
L1	280 or more
L2	100 or more
L3	80 or more
L4	250 or more

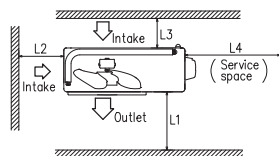
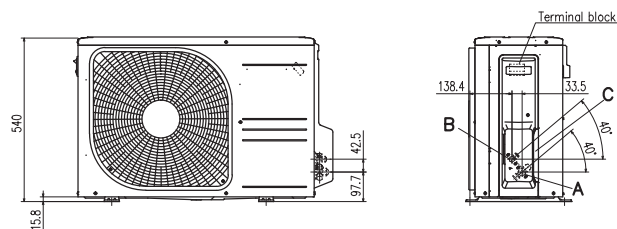

DIMENSIONS (Unit: mm)

SRC71ZR-W,-S SRC80ZR-W,-S FDC100VNP-W

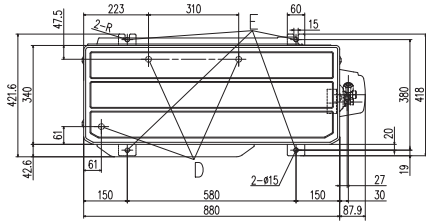

Symbol	Content	
A	Service valve connection (gas side)	ø15.88 (5/8") (Flare)
B	Service valve connection (liquid side)	ø6.35 (1/4") (Flare)
C	Pipe/cable draw-out hole	
D	Drain discharge hole	ø20 x 3 places
E	Anchor bolt hole	M10 x 4 places

Dimensions	Example of installation		
	I	II	III
L1	Open	Open	500
L2	300	250	Open
L3	100	150	100
L4	250	250	250

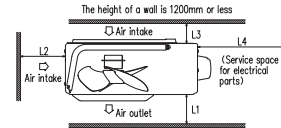
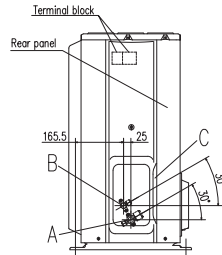
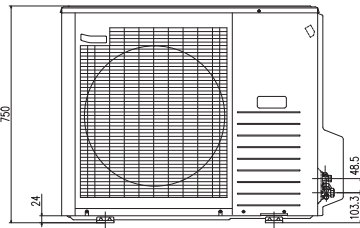

SRC15ZTL-W SRC20ZTL-W SRC25ZTL-W SRC35ZTL-W SRC25ZSP-W1,-S SRC35ZSP-W1,-S

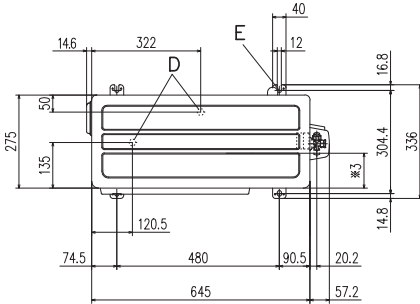

Symbol	Content	
A	Service valve connection (gas side)	ø9.52 (3/8") (Flare)
B	Service valve connection (liquid side)	ø6.35 (1/4") (Flare)
C	Pipe/cable draw-out hole	
D	Drain discharge hole	ø20x2places
E	Anchor bolt hole	M10-12x4places

Installation space	
L1	280 or more
L2	100 or more
L3	80 or more
L4	250 or more

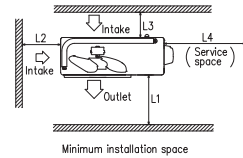
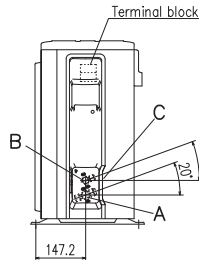
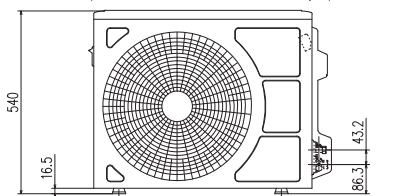

FDC100VNP

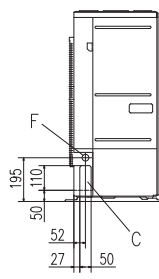
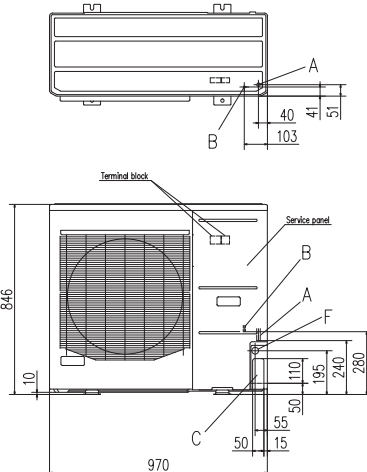

Symbol	Content	
A	Service valve connection (gas side)	ø15.88 (5/8") (Flare)
B	Service valve connection (liquid side)	ø9.52 (3/8") (Flare)
C	Pipe/cable draw-out hole	
D	Drain discharge hole	ø20x3 places
E	Anchor bolt hole	M10x4 places
F	Cable draw-out hole	ø30x3 places

- Notes
- (1) It must not be surrounded by walls on the four sides.
 - (2) The unit must be fixed with anchor bolts. An anchor bolt must not protrude more than 15mm.
 - (3) Where the unit is subject to strong winds, lay it in such a direction that the blower outlet face is perpendicular to the dominant wind direction.
 - (4) Leave 1m or more space above the unit.
 - (5) A wall in front of the blower outlet must not exceed the units height.
 - (6) The model name label is attached on the service panel.

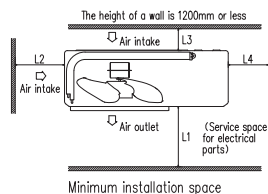
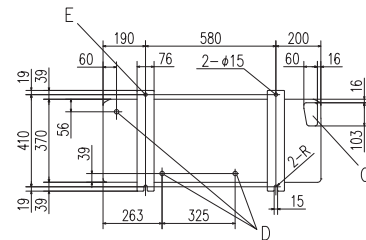

Dimensions	Example of installation		
	I	II	III
L1	Open	Open	500
L2	300	250	Open
L3	100	150	100
L4	250	250	250

OUTDOOR UNIT

SCM30ZS-W SCM40ZS-W,-S SCM45ZS-W,-S

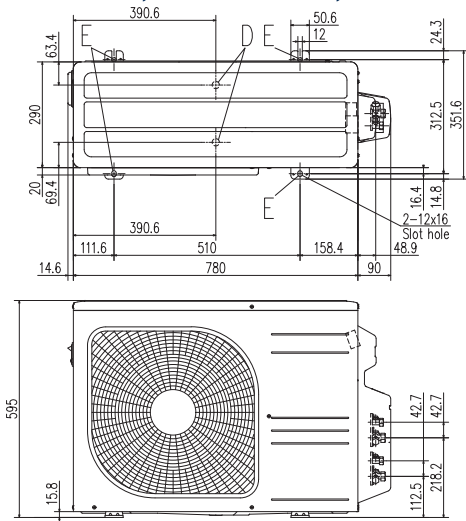

Notes

- (1) The unit must not be surrounded by walls on the four sides.
- (2) The unit must be fixed with anchor bolts. An anchor bolt must not protrude more than 15mm.
- (3) If the unit is installed in the location where there is a possibility of strong winds, place the unit such that the direction of air from the outlet gets perpendicular to the wind direction.
- (4) Leave 200mm or more space above the unit.
- (5) The wall height on the outlet side should be 1200mm or less.
- (6) The model name label is attached on the right side of the unit.

Symbol	Content
A	Service valve connection (gas side) $\phi 9.52$ (3/8") (Flare)
B	Service valve connection (liquid side) $\phi 6.35$ (1/4") (Flare)
C	Pipe / cable draw-out hole
D	Drain discharge hole $\phi 20 \times 2$ places
E	Anchor bolt hole M10-12 $\times 4$ places

	Installation space
L1	280 or more
L2	100 or more
L3	80 or more
L4	250 or more

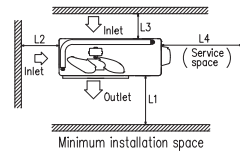
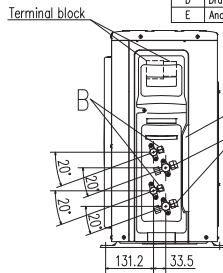

SCM41ZS-W SCM50ZS-W SCM60ZS-W SCM50ZS-S1 SCM60ZM-S1

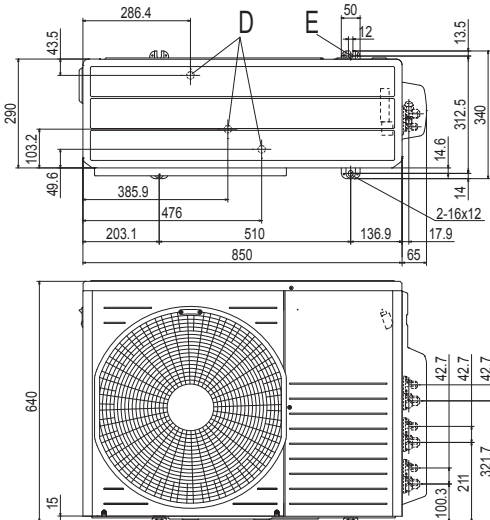

Notes

- (1) The unit must not be surrounded by walls on the four sides.
- (2) The unit must be fixed with anchor bolts. An anchor bolt must not protrude more than 15mm.
- (3) If the unit is installed in the location where there is a possibility of strong winds, place the unit such that the direction of air from the outlet gets perpendicular to the wind direction.
- (4) Leave 200mm or more space above the unit.
- (5) The wall height on the outlet side should be 1200mm or less.
- (6) The model name label is attached on the right side of the unit.

Symbol	Content
A	Service valve connection (gas side) $\phi 9.52$ (3/8") Flare
B	Service valve connection (liquid side) $\phi 6.35$ (1/4") Flare
C	Pipe / cable draw-out hole
D	Drain discharge hole $\phi 20 \times 3$ places
E	Anchor bolt hole M10-12 $\times 4$ places

	Minimum installation space
L1	600 or more
L2	100 or more
L3	100 or more
L4	No obstacles (Service space or electrical parts)

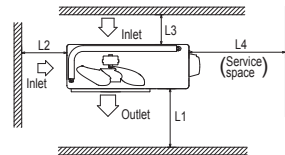
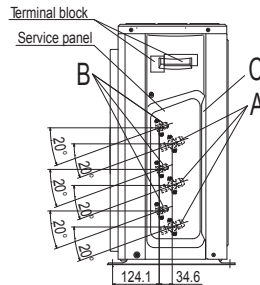

SCM71ZS-W SCM80ZS-W SCM71ZM-S1 SCM80ZM-S1

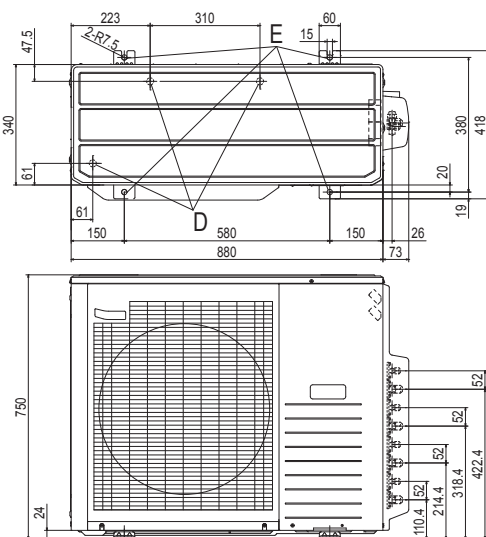

Notes

- (1) It must not be surrounded by walls on four sides.
- (2) The unit must be fixed with anchor bolts. An anchor bolt must not protrude more than 15mm.
- (3) Where the unit is subjected to strong winds, lay it in such a direction that the blower outlet faces perpendicularly to the dominant wind direction.
- (4) Leave 1.2m or more space above the unit.
- (5) A wall in front of the blower outlet must not exceed the unit's height.
- (6) The model name label is attached on the rear panel.

Symbol	Content
A	Service valve connection (gas side) $\phi 9.52$ (3/8") Flare
B	Service valve connection (liquid side) $\phi 6.35$ (1/4") Flare
C	Pipe / cable draw-out hole
D	Drain discharge hole $\phi 20 \times 3$ places
E	Anchor bolt hole M10 $\times 4$ places

Minimum installation space

Examples of Installation Dimensions	Minimum installation space		
	I	II	III
L1	Open	Open	500
L2	300	250	Open
L3	100	150	100
L4	250	250	250

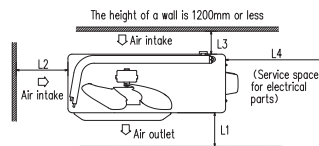
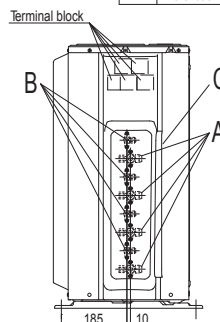

DIMENSIONS (Unit: mm)

OUTDOOR UNIT

SCM100ZS-W SCM100ZM-S

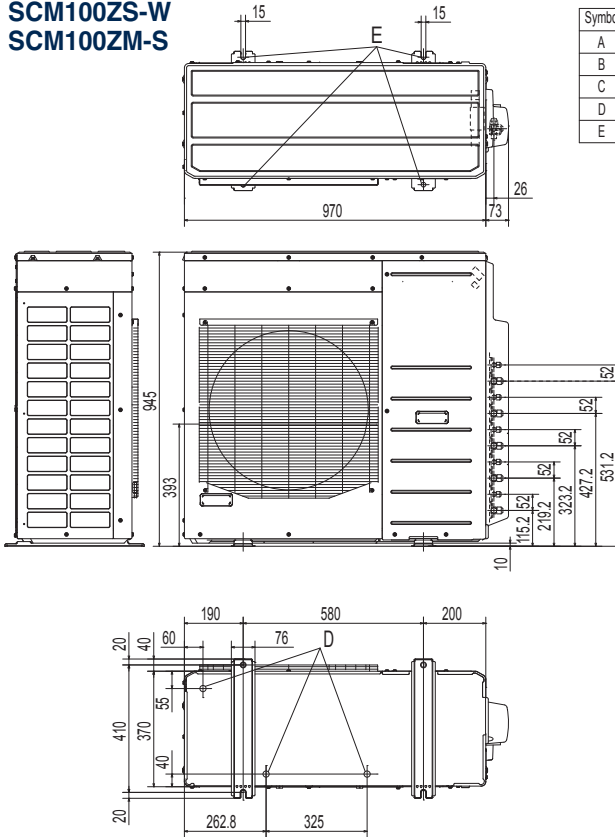

Symbol	Content
A	Service valve connection (gas side) $\phi 9.52$ (3/8") (Flare)
B	Service valve connection (liquid side) $\phi 6.35$ (1/4") (Flare)
C	Pipe/cable draw-out hole
D	Drain discharge hole $\phi 20 \times 3$ places
E	Anchor bolt hole M10 $\times 4$ places

Notes

- (1) It must not be surrounded by walls on the four sides.
- (2) The unit must be fixed with anchor bolts. An anchor bolt must not protrude more than 15mm.
- (3) Where the unit is subject to strong winds, lay it in such a direction that the blower outlet faces perpendicularly to the dominant wind direction.
- (4) Leave 1m or more space above the unit.
- (5) A wall in front of the blower outlet must not exceed the units height.
- (6) The model name label is attached on the rear panel.

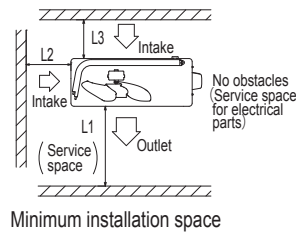
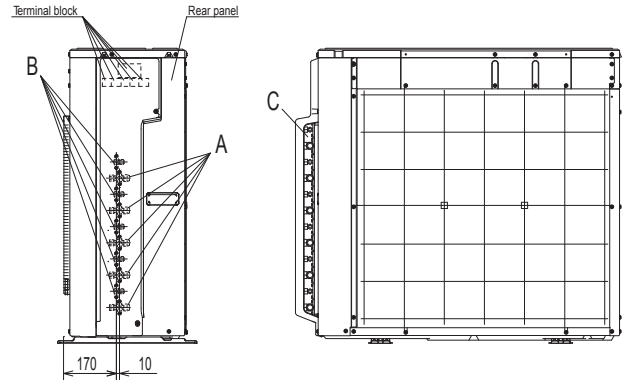

Examples of installation Dimensions	I	II	III
L1	Open	Open	500
L2	300	5	Open
L3	150	300	150

SCM125ZM-S

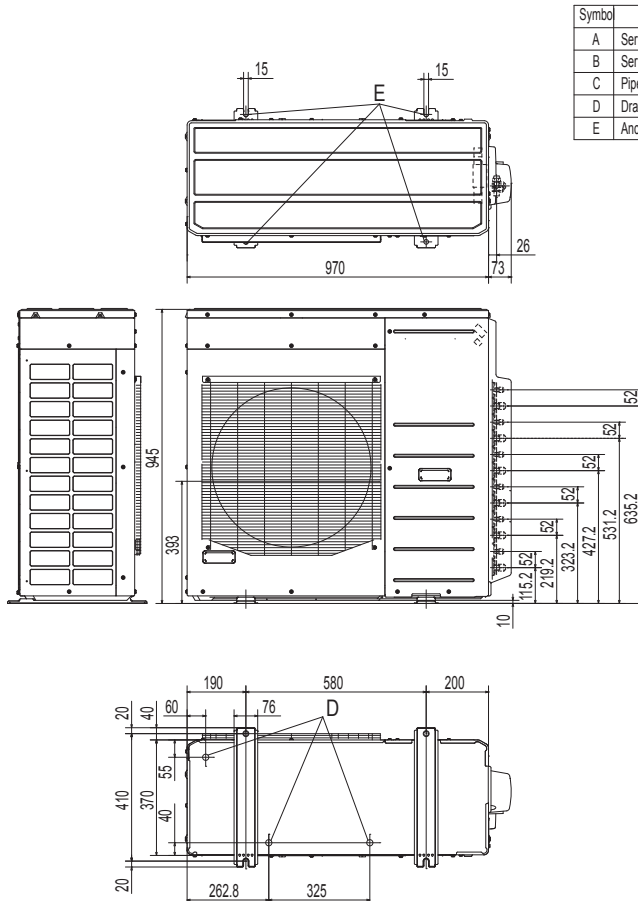

Symbol	Content
A	Service valve connection (gas side) $\phi 9.52$ (3/8") (Flare)
B	Service valve connection (liquid side) $\phi 6.35$ (1/4") (Flare)
C	Pipe/cable draw-out hole
D	Drain discharge hole $\phi 20 \times 3$ places
E	Anchor bolt hole M10 $\times 4$ places

Notes

- (1) It must not be surrounded by walls on the four sides.
- (2) The unit must be fixed with anchor bolts. An anchor bolt must not protrude more than 15mm.
- (3) Where the unit is subject to strong winds, lay it in such a direction that the blower outlet faces perpendicularly to the dominant wind direction.
- (4) Leave 1m or more space above the unit.
- (5) A wall in front of the blower outlet must not exceed the units height.
- (6) The model name label is attached on the rear panel.

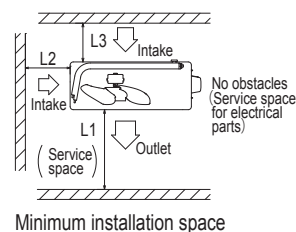
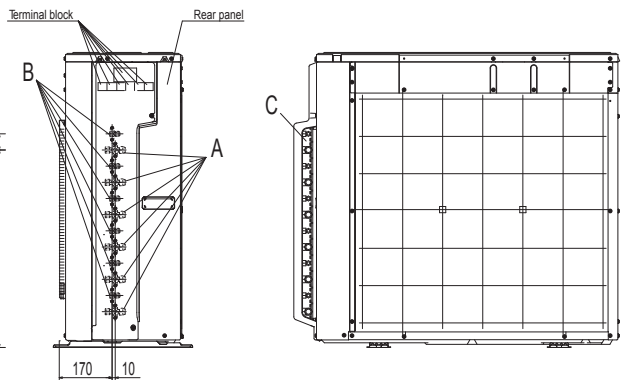

Examples of installation Dimensions	I	II	III
L1	Open	Open	500
L2	300	5	Open
L3	150	300	150

ENERGY EFFICIENT AND ENVIRONMENTALLY CONSCIOUS

ENERGY LABEL – FOR EU/EEA AREA ONLY –

SEER and SCOP is defined in European regulations listed below.

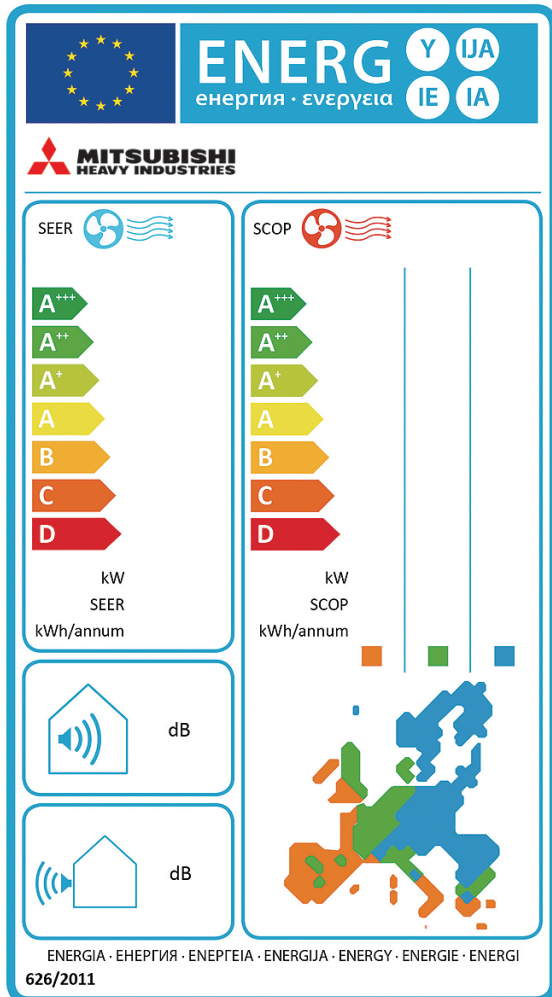

No.626/2011 of 4 May 2011:
energy labeling of air conditioners
(below cooling capacity 12kW).

No.206/2012 of 6 March 2012: requirement for air conditioners
and comfort fans.

Seasonal efficiency is the new way of rating the true efficiency
of heating and cooling products over an entire year.

Set by the EU's new regulation implementing Eco-Design
Directive for Energy related Product (ErP) which specifies the
minimum efficiency of air conditioners manufacturers must
integrate into their products.

The new Seasonal Efficiency rating system that must be used
for heating and cooling by all manufacturers are;

SEER - Seasonal Efficiency Ratio (value in cooling)

SCOP - Seasonal Coefficient of Performance (value in heating)

The new rating system will indicate the true efficiency of the
energy using product at specified condition.

Employment of lead-free solder

Adapted to RoHS directive

RoHS:Restriction of Hazardous substances

In order to avoid the release of hazardous substances into
the environments, all models have utilised lead-free solder
application. It has been considered to be difficult to use lead-
free solder for practical applications because it requires
higher solder temperatures at assembly, which can jeopardize
reliability. However our PbF soldering method can produce a
higher quality lead-free printed circuit board.

Employment of **R32** **R410A**

All models use refrigerant R32 or R410A characterized by the
ozone depletion coefficient being 0.

Excellent Energy Saving

High performance and excellent energy savings are achieved
at the same time by heat exchanger's increased capacity and
employment of high efficiency DC motor.

ENERGY EFFICIENT AND ENVIRONMENTALLY CONSCIOUS

Based on European regulations listed below, please refer the following specification table.

– Single-split –

Indoor unit	SRK20ZSX-WF ^{*1}	SRK25ZSX-WF ^{*1}	SRK35ZSX-WF ^{*1}	SRK50ZSX-WF ^{*1}	SRK60ZSX-WF ^{*1}	SRK20ZSX-W	SRK25ZSX-W
Outdoor unit	SRC20ZSX-W	SRC25ZSX-W	SRC35ZSX-W	SRC50ZSX-W2,-W3	SRC60ZSX-W1,-W3	SRC20ZSX-W	SRC25ZSX-W
Energy class (cooling/heating)	A+++/A+++	A+++/A+++	A+++/A+++	A++/A++	A++/A++	A+++/A+++	A+++/A+++
SEER	10.00	10.30	9.50	8.30	7.80	10.00	10.30
SCOP (Average climate)	5.20	5.20	5.10	4.70	4.70	5.20	5.20
Pdesign (cooling/heating(@-10°C))	kW	2.00/2.80	2.50/3.00	3.50/3.40	5.00/4.50	6.10/5.20	2.00/2.80
Annual electricity consumption (cooling/heating)	kWh/a	70/754	85/808	129/934	211/1341	274/1551	70/754
Designated heating season	Average						

Indoor unit	SRK35ZSX-W	SRK50ZSX-W	SRK60ZSX-W	SRK63ZR-WF	SRK71ZR-WF	SRK80ZR-WF	SRK100ZR-WF
Outdoor unit	SRC35ZSX-W	SRC50ZSX-W2,-W3	SRC60ZSX-W1,-W3	SRC63ZR-W	SRC71ZR-W	SRC80ZR-W	FDC100VNP-W
Energy class (cooling/heating)	A+++/A+++	A++/A++	A++/A++	A++/A++	A++/A+	A++/A+	A++/A+
SEER	9.50	8.30	7.80	8.10	7.40	7.00	6.11
SCOP (Average climate)	5.10	4.70	4.70	4.70	4.50	4.40	4.14
Pdesign (cooling/heating(@-10°C))	kW	3.50/3.40	5.00/4.50	6.10/5.20	6.30/5.40	7.10/6.60	8.00/7.10
Annual electricity consumption (cooling/heating)	kWh/a	129/934	211/1341	274/1551	273/1608	337/2055	401/2259
Designated heating season	Average						

Indoor unit	SRK63ZR-W	SRK71ZR-W	SRK80ZR-W	SRK100ZR-W	SRK20ZS-WF ^{*1}	SRK25ZS-WF ^{*1}	SRK35ZS-WF ^{*1}
Outdoor unit	SRC63ZR-W	SRC71ZR-W	SRC80ZR-W	FDC100VNP-W	SRC20ZS-W	SRC25ZS-W2	SRC35ZS-W2
Energy class (cooling/heating)	A++/A++	A++/A+	A++/A+	A++/A+	A+++/A++	A+++/A++	A++/A++
SEER	8.10	7.40	7.00	6.11	8.50	8.50	8.40
SCOP (Average climate)	4.70	4.50	4.40	4.14	4.60	4.70	4.70
Pdesign (cooling/heating(@-10°C))	kW	6.30/5.40	7.10/6.60	8.00/7.10	9.6/6.0	2.00/2.60	2.50/2.70
Annual electricity consumption (cooling/heating)	kWh/a	273/1608	337/2055	401/2259	551/2028	83/793	103/804
Designated heating season	Average						

Indoor unit	SRK50ZS-WF ^{*1}	SRK20ZS-W	SRK25ZS-W	SRK35ZS-W	SRK50ZS-W	SRK15ZTL-W	SRK20ZTL-W
Outdoor unit	SRC50ZS-W	SRC20ZS-W	SRC25ZS-W2	SRC35ZS-W2	SRC50ZS-W	SRC15ZTL-W	SRC20ZTL-W
Energy class (cooling/heating)	A++/A++	A+++/A++	A+++/A++	A++/A++	A++/A++	A++/A+	A++/A+
SEER	7.00	8.50	8.50	8.40	7.00	6.40	6.70
SCOP (Average climate)	4.60	4.60	4.70	4.70	4.60	4.40	4.40
Pdesign (cooling/heating(@-10°C))	kW	5.00/3.80	2.00/2.60	2.50/2.70	3.50/3.00	5.00/3.80	1.50/2.30
Annual electricity consumption (cooling/heating)	kWh/a	250/1158	83/793	103/804	146/895	250/1158	83/732
Designated heating season	Average						

Indoor unit	SRK25ZTL-W	SRK35ZTL-W	SRK50ZTL-W	SRK63ZTL-W	SRK71ZTL-W	SRK25ZSP-W1	SRK35ZSP-W1
Outdoor unit	SRC25ZTL-W	SRC35ZTL-W	SRC50ZTL-W	SRC63ZTL-W	SRC71ZTL-W	SRC25ZSP-W1	SRC35ZSP-W1
Energy class (cooling/heating)	A+++/A+++	A+++/A++	A++/A+	A++/A++	A++/A+	A++/A+	A++/A+
SEER	6.90	6.50	6.50	7.50	7.10	6.90	7.30
SCOP (Average climate)	4.70	4.70	4.30	4.60	4.40	4.10	4.50
Pdesign (cooling/heating(@-10°C))	kW	2.50/2.70	3.50/2.80	5.00/4.00	6.30/5.30	7.10/6.20	2.50/2.70
Annual electricity consumption (cooling/heating)	kWh/a	127/804	189/835	270/1302	295/1615	351/1972	127/923
Designated heating season	Average						

Indoor unit	SRK45ZSP-W1	SRK50ZSP-W1	SRF25ZS-W	SRF35ZS-W	SRF50ZSX-W	SRR25ZS-W	SRR35ZS-W
Outdoor unit	SRC45ZSP-W1	SRC50ZSP-W1	SRC25ZS-W2	SRC35ZS-W2	SRC50ZSX-W2,-W3	SRC25ZS-W2	SRC35ZS-W2
Energy class (cooling/heating)	A++/A+	A++/A+	A++/A+	A++/A++	A++/A++	A++/A+	A++/A+
SEER	6.40	6.30	7.40	8.10	7.50	6.60	6.80
SCOP (Average climate)	4.20	4.20	4.00	4.70	4.60	4.10	4.50
Pdesign (cooling/heating(@-10°C))	kW	4.50/3.80	5.00/3.80	2.50/2.40	3.50/2.90	5.00/4.10	2.50/2.50
Annual electricity consumption (cooling/heating)	kWh/a	247/1266	278/1266	119/840	152/864	234/1247	133/853
Designated heating season	Average						

Indoor unit	SRR50ZS-W	SRR60ZS-W	FDTC25VH1	FDTC35VH1	FDTC40VH	FDTC50VH
Outdoor unit	SRC50ZSX-W3	SRC60ZSX-W3	SRC25ZS-W2	SRC35ZS-W2	SRC40ZSX-W1	SRC50ZSX-W2,-W3
Energy class (cooling/heating)	A++/A+	A++/A+	A++/A+	A++/A++	A++/A+	A++/A+
SEER	6.50	6.20	6.80	7.10	6.94	6.52
SCOP (Average climate)	4.40	4.30	4.00	4.60	4.37	4.30
Pdesign (cooling/heating(@-10°C))	kW	5.00/4.50	5.60/5.20	2.50/2.40	3.50/2.90	4.0/4.0
Annual electricity consumption (cooling/heating)	kWh/a	270/1431	316/1692	129/840	173/883	202/1283
Designated heating season	Average					

*1 The colour variation type has the same value.

*SEER/SCOP are based on EN14825:2016 and Commission regulation (EU) No.2016/2281. Temperature conditions for calculating SCOP are based on "Average climate".

Indoor unit	FDTC60VH	SRK20ZSX-S	SRK25ZSX-S	SRK35ZSX-S	SRK50ZSX-S	SRK60ZSX-S	SRK63ZR-S	
Outdoor unit	SRC60ZSX-W1,-W3	SRC20ZSX-S	SRC25ZSX-S	SRC35ZSX-S	SRC50ZSX-S	SRC60ZSX-S	SRC63ZR-S	
Energy class (cooling/heating)		A++/A+	A+++/A+++	A+++/A+++	A+++/A+++	A++/A++	A++/A++	A++/A++
SEER		6.45	9.50	9.60	9.20	8.20	7.60	7.60
SCOP (Average climate)		4.10	5.20	5.20	5.10	4.70	4.70	4.70
Pdesign (cooling/heating(@-10°C))	kW	5.6/5.1	2.00/2.70	2.50/2.90	3.50/3.30	5.00/4.50	6.10/5.20	6.30/5.40
Annual electricity consumption (cooling/heating)	kWh/a	304/1744	74/728	92/781	134/906	214/1341	282/1551	291/1610
Designated heating season		Average						

Indoor unit	SRK71ZR-S	SRK80ZR-S	SRK100ZR-S	SRK20ZS-S ¹	SRK25ZS-S ¹	SRK35ZS-S ¹	SRK50ZS-S ¹	
Outdoor unit	SRC71ZR-S	SRC80ZR-S	FDC100VNP	SRC20ZS-S	SRC25ZS-S	SRC35ZS-S	SRC50ZS-S	
Energy class (cooling/heating)		A++/A+	A++/A+	A++/A+	A++/A++	A++/A++	A++/A++	A++/A+
SEER		7.20	6.60	6.60	7.80	7.80	7.80	6.26
SCOP (Average climate)		4.50	4.40	4.40	4.60	4.60	4.60	4.20
Pdesign (cooling/heating(@-10°C))	kW	7.10/6.60	8.00/7.10	10.0/7.20	2.00/2.40	2.50/2.50	3.50/2.80	5.00/3.90
Annual electricity consumption (cooling/heating)	kWh/a	346/2055	425/2261	531/2289	90/732	113/762	158/852	280/1300
Designated heating season		Average						

Indoor unit	SRK25ZSP-S	SRK35ZSP-S	SRK45ZSP-S	SFR25ZMX-S	SFR35ZMX-S	SFR50ZMX-S	SRR25ZM-S	
Outdoor unit	SRC25ZSP-S	SRC35ZSP-S	SRC45ZSP-S	SRC25ZMX-S	SRC35ZMX-S	SRC50ZSX-S	SRC25ZMX-S	
Energy class (cooling/heating)		A/A	A++/A+	A/A	A++/A+	A++/A+	A++/A	A++/A+
SEER		5.50	6.15	5.38	7.11	6.75	6.12	6.43
SCOP (Average climate)		3.80	4.00	3.81	4.37	4.26	3.87	4.08
Pdesign (cooling/heating(@-10°C))	kW	2.50/2.80	3.20/3.00	4.50/3.80	2.50/3.00	3.50/3.30	5.00/4.80	2.50/3.30
Annual electricity consumption (cooling/heating)	kWh/a	160/1033	183/1052	293/1398	123/961	182/1085	286/1736	136/1133
Designated heating season		Average						

Indoor unit	SRR35ZM-S	FDTC25VF	FDTC35VF	FDTC40VF	FDTC50VF	FDTC60VF	
Outdoor unit	SRC35ZMX-S	SRC25ZMX-S	SRC35ZMX-S	SRC40ZSX-S	SRC50ZSX-S	SRC60ZSX-S	
Energy class (cooling/heating)		A++/A+	A++/A+	A++/A+	A++/A	A+/A	A+/A
SEER		6.33	6.10	6.12	6.53	6.01	5.76
SCOP (Average climate)		4.02	4.13	4.15	3.96	3.85	3.80
Pdesign (cooling/heating(@-10°C))	kW	3.50/3.55	2.55/3.10	3.60/3.60	4.00/4.00	5.00/4.80	5.60/5.90
Annual electricity consumption (cooling/heating)	kWh/a	194/1238	147/1050	207/1215	215/1416	291/1745	341/2172
Designated heating season		Average					

– Multi-split System

Indoor unit	SRK15ZS-WF x 2	SRK20ZSX-W x 2	SRK20ZSX-W SRK25ZSX-W	SRK15ZS-WF x 3	SRK20ZSX-W x 3	SRK20ZSX-W x 4	SRK20ZSX-W x 5			
Outdoor unit	SCM30ZS-W	SCM40ZS-W	SCM45ZS-W	SCM41ZS-W	SCM50ZS-W	SCM60ZS-W	SCM71ZS-W	SCM80ZS-W	SCM100ZS-W	
Energy class (cooling/heating)		A+++/A++	A+++/A++	A+++/A+++	A+++/A++	A+++/A++	A+++/A++	A+++/A++	A+++/A+	
SEER		8.60	9.10	9.10	9.20	8.80	8.80	8.30	8.20	8.60
SCOP (Average climate)		4.80	4.70	4.70	4.60	4.60	4.60	4.60	4.60	4.50
Pdesign (cooling/heating(@-10°C))	kW	3.00/3.30	4.00/4.10	4.50/4.10	4.00/3.40	5.00/4.70	6.00/4.70	7.10/6.70	8.00/6.70	10.00/6.80
Annual electricity consumption (cooling/heating)	kWh/a	123/962	154/1222	174/1222	153/1034	199/1430	239/1430	300/2038	342/2038	407/2116
Designated heating season		Average								

Indoor unit	SRK20ZSX-W x 2	SRK20ZSX-W SRK25ZSX-W	SRK20ZSX-W x 3	SRK20ZSX-W x 4	SRK20ZSX-W x 5	SRK25ZS-W+ SRK35ZS-W x 3			
Outdoor unit	SCM40ZS-S	SCM45ZS-S	SCM50ZS-S1	SCM60ZM-S1	SCM71ZM-S1	SCM80ZM-S1	SCM100ZM-S	SCM125ZM-S*	
Energy class (cooling/heating)		A++/A+	A++/A+	A++/A+	A++/A+	A++/A+	A++/A+	A/A+	-
SEER		6.31	6.43	6.80	6.80	7.20	7.10	5.10	5.61
SCOP (Average climate)		4.05	4.11	4.40	4.20	4.20	4.20	4.02	4.11
Pdesign (cooling/heating(@-10°C))	kW	4.00/3.30	4.50/4.10	5.00/4.90	6.00/7.30	7.10/8.10	8.00/8.20	10.00/10.10	-
Annual electricity consumption (cooling/heating)	kWh/a	222/1140	245/1396	258/1559	309/2435	346/2700	395/2733	687/3519	-
Designated heating season		Average							

Before starting use

Heating performance

The heating performance values (kW) described in the catalogue are the values obtained by operating at an outdoor temperature of 7°C and indoor temperature of 20°C as set forth in the ISO Standards. Heating performance is reduced as the temperature drops. If the outdoor temperature is too low and the heating performance is insufficient, use other heating appliances as well.

Indication of sound values

The sound values are the values (A scale) measured in a chamber such as an anechoic chamber following the ISO Standards. In the actual installation state, the value is normally larger than the values given in the catalogue due to the effect of surrounding noise and echo. Take this into consideration when installing.

Use in oil atmosphere

Avoid installing this unit in an atmosphere where oil scatters or builds up, such as in a kitchen or machine factory.

If the oil adheres to the heat exchanger, the heat exchanging performance will drop, mist may be generated, and the synthetic resin parts may deform and break.

Use in acidic or alkaline atmosphere

If this unit is used in acidic atmosphere such as hot spring areas having high level of sulfuric gases or in alkaline atmosphere including ammonia or calcium chloride, places where the exhaust of the heat exchanger is sucked in, or at coastal areas where the unit is subject to salt breezes, the outer plate or heat exchanger, etc., will corrode. Please ask a dealer or specialist when you use an air conditioner in places differing from a general atmosphere.

Use in places with high ceilings

If the ceiling is high, install a circulator to improve the heat and air flow distribution when heating.

Refrigerant leakage

The refrigerant (R32, R410A) used for air conditioner is non-toxic and in its original state.

However, in consideration of a state where the refrigerant leaks into the room, measures against refrigerant leaks must be taken in small rooms where the tolerable level could be exceeded. Take measures by installing ventilation devices, etc.

Use in snowy areas

Take the following measures when installing the outdoor unit in snowy areas.

·Snow prevention

Install a snow-prevention hood so that the snow does not obstruct the air intake port or enter and freeze in the outdoor unit.

·Snow piling

In areas with heavy snow fall, the piled snow could block the air intake port. In this case, a frame that is 50cm or higher than the estimated snow fall must be installed underneath the outdoor unit.

Automatic defrosting device

If the temperature is low, and the humidity is high, frost will stick to the heat exchanger of the outdoor unit. If continued to use, the heating performance will drop.

The "Automatic defrosting device" will function to remove this frost.

After heating for approx. three to ten minutes, it will stop, and the frost will be removed. After defrosting, hot air will be blown again.

Servicing

After the air conditioner has been used for several seasons, dirt will build up in the air conditioner causing the performance to drop. In addition to regular servicing, a maintenance contract by a specialist is recommended.

Safety Precautions

Air conditioner usage target

The air conditioner described in this catalogue is a dedicated cooling/heating device for human use.

Do not use it for special applications such as the storage of food items, animals or plants, precision devices or valuable art, etc.

This could cause the quality of the items to drop, etc.

Do not use this for cooling vehicles or ships. Water leakage or current leaks could occur.

Before use

Always read the "User's Manual" thoroughly before starting use.

Installation

Always commission the installation to a dealer or specialist. Improper installation will lead to water leakage, electric shocks and fires.

Make sure that the outdoor unit is stable in installation. Fix the unit to stable base.

Usage place

Do not install in places where combustible gas could leak or where there are sparks.

Installation in a place where combustible gas could be generated, flow or accumulate, or places containing carbon fibers could lead to fires.

Mitsubishi Heavy Industries Thermal Systems, Ltd.

(Wholly-owned subsidiary of MITSUBISHI HEAVY INDUSTRIES, LTD.)

2-3, Marunouchi 3-chome, Chiyoda-ku, Tokyo, 100-8332, Japan

<https://www.mhi-mth.co.jp/en/>

Our factories are ISO9001 and ISO14001 certified.

Certified ISO 9001



Certificate Number: JQA-0709

Certified ISO 14001



Mitsubishi Heavy Industries Thermal Systems, Ltd. Participate in the Eurovent certification program for comfort air conditioner (AC1 & AC2). Check ongoing validity of certificate: www.eurovent-certification.com

